



Providing sustainable energy solutions worldwide

Installation and Maintenance Manual

CTC GS 6-8

Ground Source Heat Pump

400 V 3N~



IMPORTANT

READ CAREFULLY BEFORE USE
SAVE FOR FUTURE REFERENCE

Removing the cooling module



1. Disconnect the cooling module's power cable connector and hoses.



2. Attach the two carrying handles to the bottom of the cooling module.



3. Unscrew the cooling module's screws.



4. Pull the cooling module by first lifting the front edge slightly with the carrying handles.



5. Lift the cooling module using the carrying handles and shoulder straps.

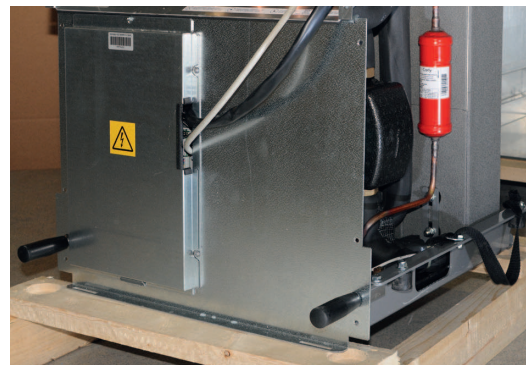

6. Lift the cooling module into the product using the carrying handles and shoulder straps. Remove the carrying handles and reconnect the power cable, hoses and screws.

Installation and Maintenance Manual

162 205 96-2 2018-11-08

CTC GS 6-8

Ground Source Heat Pump

400 V 3N~



Important information on air bleeding

For the product to work as intended, the system must be fully bled.

It is extremely important that a basic bleeding of the product is carried out systematically and carefully.

Bleeding devices must be fitted to the system's natural high points. A basic bleeding of the hot water tank can be carried out upon installation by releasing the safety valve, which must be fitted to the top of the product.

The water must be circulated in the various subsystems, the radiator systems, the heat pump system and the hot water charging system (to run pumps, diverting valve etc. manually, go into the menu Advanced/Service/Function test). Also activate the diverting valve during the bleeding process. A careful basic bleeding must be carried out before the system is put into operation and the heat pump is started.

Tip!

Once basic bleeding is complete: increase the water pressure in the system to approx. 2 bar.

- Automatic bleeding valves are included in the package and supplied as standard for this product. They must be fitted to the top of the product as shown in the picture.
- Important! Bleed any air remaining in the radiators (elements) and other parts of the system after it has been in operation for a short time.

Small microbubbles gradually collect in the system's "pockets", and it can take quite a long time before all the air is removed from the system. When the pressure is temporarily increased, any remaining air pockets are compressed and carried along more easily with the flow of water, and can be released into the ventilation devices.

Tip!

After the air is bled, there may be a drop in system pressure. Having the system pressure too low increases the risk of noise in the system and of air being "sucked" in on the suction side of the pump. Keep an eye on the system pressure. Bear in mind that it is completely normal for the system pressure to vary in the course of the year due to changes in temperature in the heating system.

If "gushing" sounds can be heard from the product, this is a sign of remaining air.

A loss of heating functionality can also be a sign of remaining air.

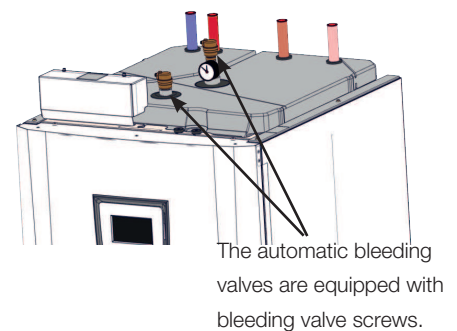

Information in this type of box [i] is intended to help ensure that the product functions optimally.



Information in this type of box [!] is particularly important for correctly installing and using the product.

Innehållsförteckning

Important information on air bleeding	4	11. Detailed menu descriptions	62
Important to remember!	8	11.1 Start menu	62
Your home's heating settings	10	11.2 Room temperature	63
1. Technical data	14	11.3 DHW	67
1.1 Operating range CTC GS 6-8	16	11.4 Operation	69
2. Design	18	11.5 Installer	76
3. Parameter list	19	11.6 Heat pump	81
4. Installation	22	11.7 Electric heater	82
4.1 Transportation	22	11.8 DHW tank	83
4.2 Unpacking	22	11.9 Communication	85
4.3 Control functions (std.) and with Expansion Card	23	11.10 Cooling	85
5. Pipe installation	24	11.11 Solar panels (accessories)	86
5.1 Schematic diagram	24	11.12 Diff thermostat function	91
6. Connecting the brine system	35	11.13 Pool (accessory)	92
6.1 Connections	35	11.14 External heat source (EHS)	92
6.2 Brine system schematic diagram	38	11.15 EcoVent (accessory)	93
6.3 Coolant pump (G20)	40	11.16 Define system	94
7. Electrical installation	41	11.17 Define remote control	98
7.1 Sensor connection	42	11.18 Remote control procedure	98
7.2 Checking connected sensors	43	11.19 Smart Grid	101
7.3 Pressure/level switch	43	11.20 Service	104
7.4 Installing a backup power supply	43	12. Troubleshooting/appropriate measures	110
7.5 Pump Diff thermostat function (G46) on/off	43	12.1 Information messages	113
7.6 Heating circuit 2 (alt. Free cooling)	44	12.2 Alarm messages	115
7.7 Pool (accessory)	45		
7.8 External heat source (EHS)	45		
7.9 CTC EcoVent (accessory)	45		
7.10 CTC SmartControl (accessory)	45		
7.11 Solar heat (accessory)	46		
7.12 Current sensor connection (accessory)	47		
7.13 Tank schematic diagram (A2)	48		
7.14 HP cooling module schematic diagram (A5)	50		
7.15 Expansion card (accessory) schematic diagram (A3)	51		
7.16 Parts list	53		
7.17 Resistances for sensors	54		
8. First start	56		
9. Operation and Maintenance	58		
10. Menu overview	60		

For your own reference

Fill in the information below. It may come in useful if anything should happen.

Product:	Serial number:
Installer:	Name:
Date:	Tel. no.:
Electrical installer:	Name:
Date:	Tel. no.:

Congratulations on your new product



You have just purchased a CTC GS 6-8, with which we hope you will be very pleased. Read about how you can take care of your heat pump on the following pages.

Save this manual containing the installation and maintenance instructions. If the heat pump is properly maintained, you will be able to enjoy the use of your CTC GS 6-8 for many years. This manual will provide all the information you will need.

The complete heat pump

CTC GS 6-8 is a complete heat pump which meets your home's heating and hot water requirements. It has a built-in, energy-efficient (A rated) circulation pump for connection to the ground/bedrock circuit, i.e. the cold side. This can be connected to either the left, right or back of the heat pump, whichever suits you best.

CTC GS 6-8 has a control system which:

- Monitors all heat pump functions
- Permits individual settings
- Displays desired values, such as temperatures, operation times, energy consumption and fault signals
- Facilitates the setting of values and troubleshooting in a simple and well-structured way

The built-in heat exchanger provides copious amounts of hot water. CTC GS 6-8 also has a so-called summer-time basement heating function and a floor heating block, which maximises the temperature supplied to the floor elements. Using the integrated night reduction function, you can set and change the temperature in the house throughout the day, from one day to the next.

Its easily accessible electrical components and cooling module, along with effective troubleshooting functions in the control program, make CTC GS 6-8 easy to service.

If you want to supplement your CTC GS 6-8 with other sources of heating, you can do this easily. We have decided to call this option Energyflex. With Energyflex you can, for example:

- Charge your heating circuit with solar energy
- Allow a water-jacketed stove to contribute heat
- Connect a pool heat exchanger to heat up a swimming pool

Important to remember!

Check the following points in particular at the time of delivery and installation:

- The product must be transported and stored in an upright position.
- Remove the packaging and check before installation that the product has not been damaged in transit. Report any transport damage to the carrier.
- Place the product on a solid foundation, preferably made of concrete.
If the product needs to be placed on a soft carpet, base plates must be placed under the adjustable feet.
- Remember to leave a service area of at least 1 metre in front of the product.
- The product must not be placed below floor level either.
- Avoid placing the heat pump in rooms where the walls are of lightweight design, as people in the adjoining room may be disturbed by the compressor and vibrations.
- For installation in a newly built dwelling, the regulations of the Swedish National Board of Housing, Building and Planning (Boverket) must be adhered to when setting maximum electrical output. The installer must key in the four-digit code 8818 under the menu: Service/Factory settings coded, within one week – this locks maximum power.

Safety instructions



Turn off the power with an omnipolar switch before doing any work on the product.



The product must be connected to protective earth.



The product is classified as IPX1. The product must not be rinsed with water.



When handling the product with a hoist ring or similar device, make sure that the lifting equipment, eyebolts and other parts are not damaged. Never stand under the hoisted product.



Never jeopardise safety by removing bolted covers, hoods or similar.



Any work on the product's cooling system should be carried out by authorised personnel only.



The product's electrical systems should only be installed and serviced by a qualified electrician.

-If the supply cord is damaged, it must be replaced by the manufacturer, its service agent or similarly qualified persons in order to avoid a hazard.



Safety valve check:

-Safety valve for boiler/system to be checked regularly.



The product must not be started if it is not filled with water; instructions are in the "Pipe installation" section.



WARNING: Do not switch on the product if there is a possibility that the water in the heater is frozen.



This device can be used by children from the age of eight years and above and by people with reduced physical, sensory or mental ability or lack of experience or knowledge if they have been taught, either with supervision or with the instructions provided, how to use the device safely and understand the risks involved. Children should not play with the device. Cleaning and maintenance should not be carried out by children without supervision.



If these instructions are not followed when installing, operating and maintaining the system, Enertech's commitment under the applicable warranty terms is not binding.

Your home's heating settings

The House Heating Curve

The heating curve is the central part of the product's control system. It is the heating curve which determines the compensated flow temperature requirements for your property dependent upon the outdoor temperatures. It is important that the heating curve is correctly adjusted, so that you achieve the best operation and economy possible.

One property requires a radiator temperature of 30 °C when the outdoor temperature is 0 °C, whilst a different property requires 40 °C. The difference between different properties is determined by the radiator surface area, the number of radiators and how well insulated the house is.

I The set heating curve always takes priority. The room sensor can only increase or decrease the heat beyond the set heating curve to a certain extent. Where operating without a room sensor, the selected heating curve determines the flow temperature supplied to the radiators.

Adjustment of Default Values for the Heating Curve

You define the heating curve yourself for your property by setting two values in the product control system. This is achieved by selecting the options Inclination or Adjustment under the Installer/Settings/Radiator system menu. Ask your installer to help you set these values.

It is extremely important to set the heating curve and, in some cases, unfortunately, this process may take several weeks. The best way of doing this, upon the initial start-up, is to select operation without any room sensor. The system then operates using the outdoor temperature reading and the property's heating curve only.

During the adjustment period it is important that:

- the night reduction function is not selected.
- all thermostat valves on the radiators be fully opened. (This is to find the lowest curve for the most economical use of the heat pump.)
- the outdoor temperature is not higher than +5 °C. (If the outdoor temperature is higher when the system is installed, use the factory set curve until the outdoor temperature falls to a suitable level.)
- the radiator system is operational and correctly adjusted between different circuits.

Appropriate Default Values

During installation you can seldom achieve a precise setting for the heating curve instantly. In this case, the values given below may provide a good starting point. Radiators with small heat-emission surfaces require a higher primary flow temperature. You can adjust the gradient (heating curve gradient) for your heating system under the Installer/Settings/Radiator system menu.

Recommended values are:

Floor heating only	Inclination 35
Low temperature system (well insulated houses)	Inclination 40
Normal temperature system (factory setting)	Inclination 50
High temperature system (older houses, small radiators, poorly insulated)	Inclination 60

Adjusting the heating curve

The method described below can be used to adjust the heating curve correctly.

Adjustment if it is too **cold** indoors

- If the outdoor temperature is **lower** than 0 degrees:
Increase the Inclination value by a couple of degrees.
Wait 24 hours to see if any further adjustment is required.
- If the outdoor temperature is **higher** than 0 degrees:
Increase the Adjustment value by a couple of degrees.
Wait 24 hours to see if any further adjustment is required.

Adjustment if it is too **warm** indoors

- If the outdoor temperature is **lower** than 0 degrees:
Decrease the Inclination value by a couple of degrees.
Wait 24 hours to see if any further adjustment is required.
- If the outdoor temperature is **higher** than 0 degrees:
Decrease the Adjustment value by a couple of degrees.
Wait 24 hours to see if any further adjustment is required.

I If the values set are too low, this may mean that the desired room temperature is not being reached. You then need to adjust the heating curve, as necessary, following the method shown above.
When the basic values have been set more or less correctly, the curve can be finely adjusted directly using the Room temp. shown on the home menu screen.

Examples of Heating Curves

You can see in the diagram below how the heating curve changes with different Inclination settings. The gradient of the curve shows the temperatures that the radiators require at different outdoor temperatures.

Curve Inclination

The inclination value which is set is the primary flow temperature when the outside temperature is $-15\text{ }^{\circ}\text{C}$.

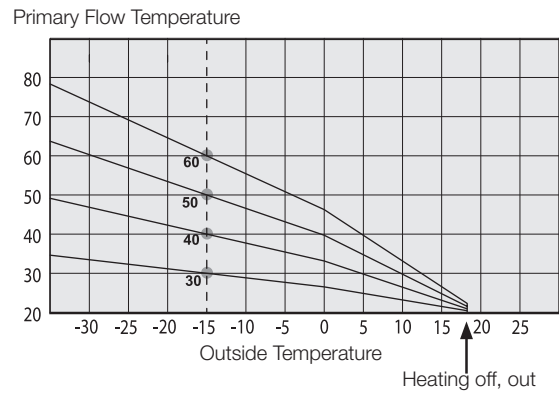

Adjustment

The curve can be parallel displaced (adjusted) by the desired number of degrees to adapt to different systems/houses.

Inclination $50\text{ }^{\circ}\text{C}$
Adjustment $+5\text{ }^{\circ}\text{C}$

Inclination $50\text{ }^{\circ}\text{C}$
Adjustment $0\text{ }^{\circ}\text{C}$

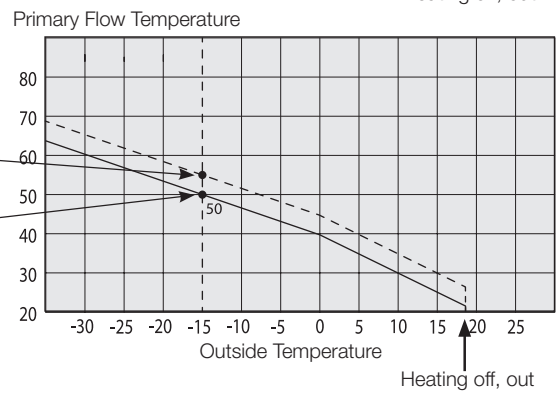

An example

Inclination $60\text{ }^{\circ}\text{C}$
Adjustment $0\text{ }^{\circ}\text{C}$

In this example, the maximum outgoing primary flow temperature is set at $55\text{ }^{\circ}\text{C}$.

The minimum permitted primary flow temperature is $27\text{ }^{\circ}\text{C}$ (e.g. summer-time basement heating or the floor circuits in a bathroom).

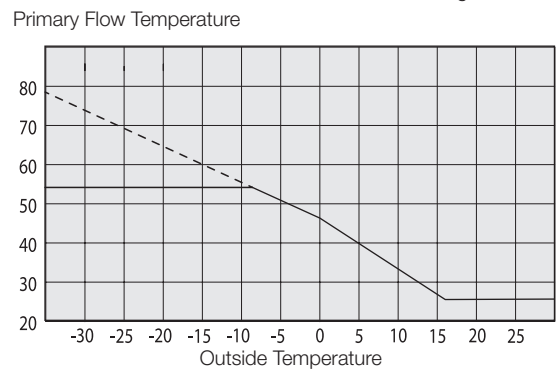

Summer-time operation

All properties have internal heat gains (lamps, oven, body heat, etc.), which means that the heating can be switched off when the outdoor temperature is lower than the desired room temperature. The better insulated the house is, the earlier the heating from the heat pump can be switched off.

The example shows the product set at the default value of 18°C. This value, "**Heating off, outside**", can be changed in the Advanced/Settings/Heat System menu. In systems with a radiator pump, the radiator pump stops when the heat is switched off. The heating starts up automatically when it is required again.

Automatic or remote-controlled summer period

The factory setting causes "summer" to commence automatically at 18°C, as "Heating mode" is set to "Auto".

Heating, mode **Auto (Auto/On/Off)**

Auto means automatic.

On means that the heating is on. For systems with a mixing valve and a radiator pump, the mixing valve operates to the primary flow setpoint and the radiator pump is on.

Off means that the heating is switched off. For systems with a radiator pump, the radiator pump is switched off.

Heating, ext. mode **- (- /Auto/On/Off)**

Facility for remote control of whether the heating is to be on or off.

Auto means automatic.

On means that the heating is on. For systems with a mixing valve and a radiator pump, the mixing valve operates to the primary flow setpoint and the radiator pump is on.

Off means that the heating is switched off. For systems with a radiator pump, the radiator pump is switched off.

- No selection means no function when activated.

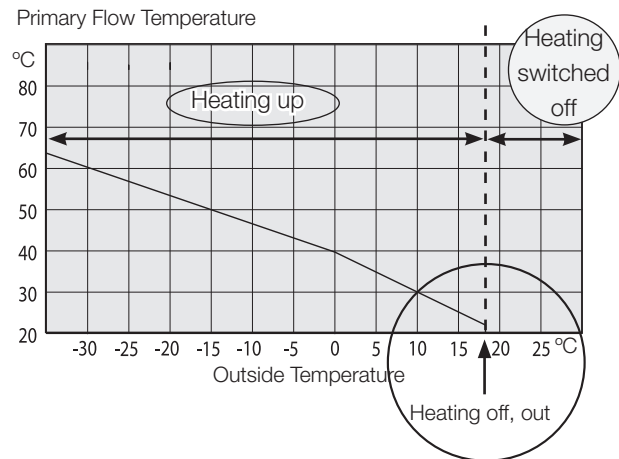

1. Technical data

Electrical data		GS 6	GS 8
Electrical data		400V 3N~ 50 Hz	
Rated power	kW	11,5	12,7
Max starting current	A	16,6	17,7
Immersion heater (steps of 0,3 kW)	kW	9	
Max immersion heater output @ fuse size 10 / 16 / 20 / 25 A	kW	2,1 / 6,9 / 9 / 9	2,1 / 6,9 / 7,8 / 9
Max. operating current Compressor	A	3,5	5,1
Maximum permitted impedance at connection*	Ω	0,18	
IP class		IPX1	

*Maximum permitted impedance at the mains connection according to EN 61000-3-12. If the impedance at the mains connection is higher than the specified, check with the grid owner before purchasing the equipment.

Operational data for heat pump		GS 6	GS 8
Output from compressor ¹⁾ @ 0/35 0/45 0/55	kW	6.04 5.59 5.31	8.29 7.87 7.47
COP ¹⁾ @ 0/35 0/45 0/55	-	4.52 3.52 2.71	4.77 3.63 3.08
Output ¹⁾ @ 5/35 5/45 5/55	kW	6.80 6.49 6.24	9.52 8.96 8.59
COP ¹⁾ @ 5/35 5/45 5/55	-	5.11 4.03 3.15	5.40 4.24 3.49
Nominal heating output (P_{Design}) moderate climate 35/55 °C	kW	6.9 / 6.4	9.4 / 8.6
Nominal heating output (P_{Design}) cold climate 35/55 °C	kW	6.6 / 6.0	9.1 / 8.5
SCOP moderate climate (EN 14825) @ 0/35 0/55		4.7 / 3.7	5.0 / 3.9
SCOP cold climate (EN 14825) @ 0/35 0/55		4.8 / 3.8	5.0 / 4.0

¹⁾ EN14511:2013, incl. heating medium pump and brine pump

Heating system		GS 6	GS 8
Water volume (V)	l	229	
Max. operating pressure boiler (PS)	bar	3.0	
Max. temperature boiler (TS)	°C	100	
Heating medium system min flow ²⁾	l/s	0.14	0.20
Heating medium system nominal flow ³⁾	l/s	0.28	0.39
Pressure drop		See diagram in chapter Pipe installation	

²⁾ At $\Delta t = 10$ K and 0/35 °C heat pump operation.
³⁾ At $\Delta t = 5$ K and 0/35 °C heat pump operation.

Brine system		GS 6	GS 8
Water volume (V)	l	2,3	2,9
Brine system min/max temp (TS)	°C	-5 / +20	
Brine system max pressure (PS)	bar	3.0	
Brine system min. flow, $\Delta t = 5$ K	l/s	0.22	0.31
Brine system nominal flow, $\Delta t = 3$ K	l/s	0.37	0.51
Pump capacity		See diagram in chapter Pipe installation	

DHW system		GS 6	GS 8
Water volume (V)	l	1.7	
Max operating pressure (PS)	bar	10	
Max operating temperature (TS)	°C	100	
DHW capacity according to. prEN16147		Economic/Normal/Comfort	
DHW capacity	l	210 / 239 / 304	210 / 241 / 304
COP/ (Tapping cycle, L/ XL/ XL)		2.19 / 2.49 / 2.32	2.58 / 2.78 / 2.57

Pipe connections		GS 6	GS 8
Brine circuit, ext. diam. Cu piping (flexible hose)	mm	28	
Heating medium, ext. diam. Cu piping	mm	22	
Hot water supply, ext. diam.	mm	22	
Cold water supply, ext. diam.	mm	22	

Other data		GS 6	GS 8
Refrigerant quantity (R407C, fluorinated greenhouse gases GWP 1774)	kg	1,9	
CO ₂ equivalent	ton	3.370	
Interrupt value switch HT	MPa/bar	3.1/31	
Weight with/without packaging	kg	267 / 237	270 / 240
Depth x Width x Height	mm	673 x 596 x 1882	673 x 596 x 1882
Required ceiling height	mm	1940	
Noise level (L _{WA}) according to EN 12102 vid 0/35	dB(A)	41	39
Heat pump Keymark Cert.NO.		012-SC1212-17	012-SC1263-17

No annual leakage control of the refrigerant is required

1.1 Operating range CTC GS 6-8

Operating range is based on normal operating conditions and may therefore be different in different installations.

(t_{ci} = temperature brine in)

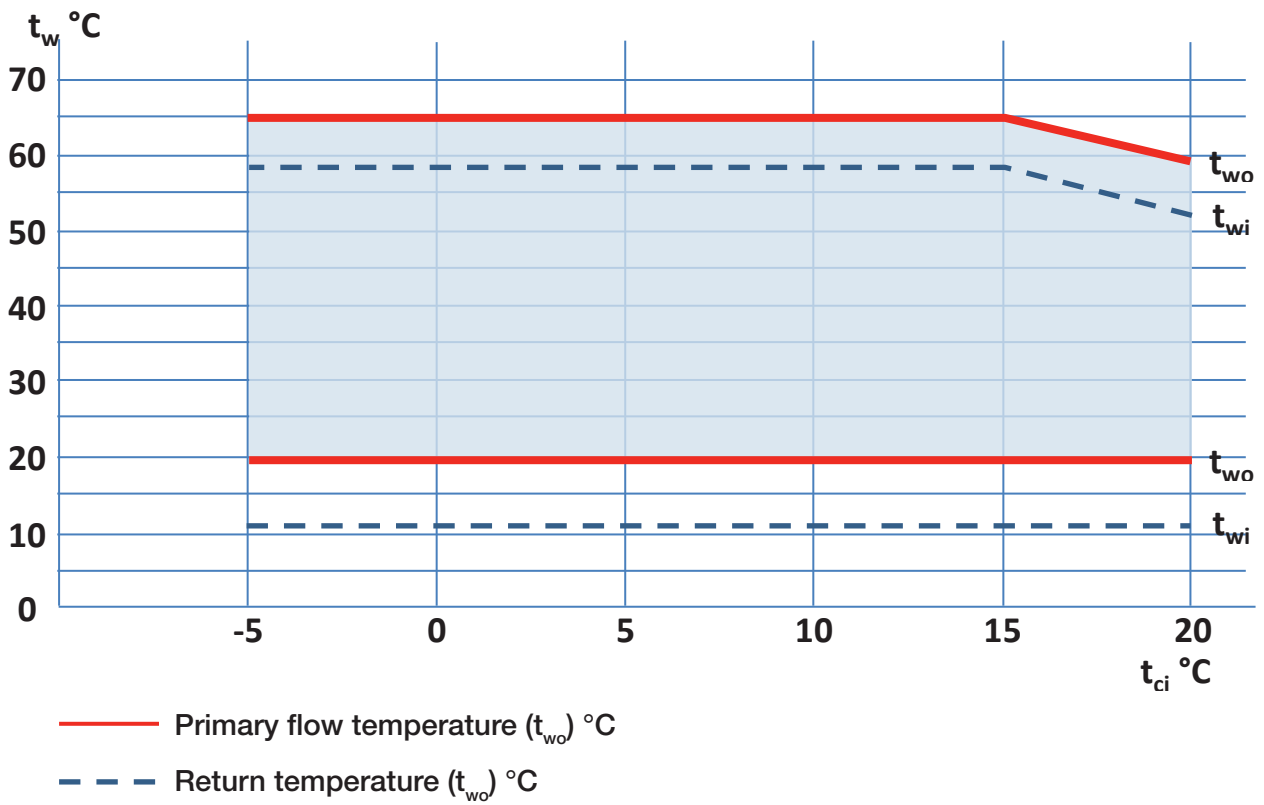

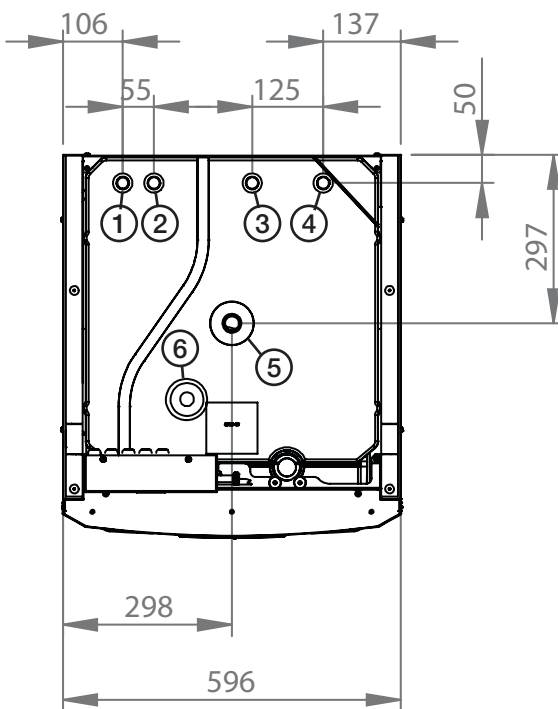
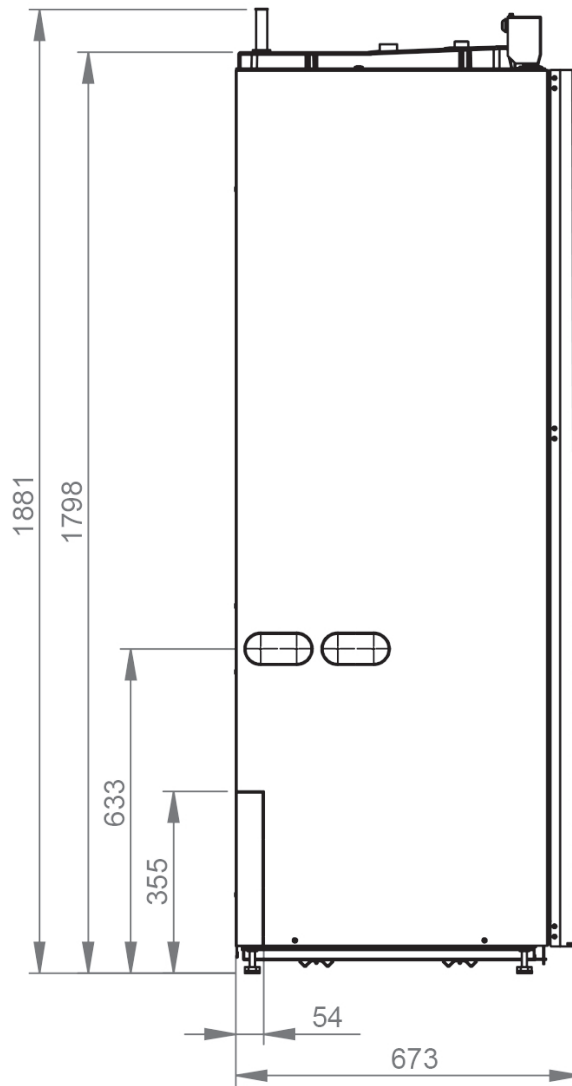
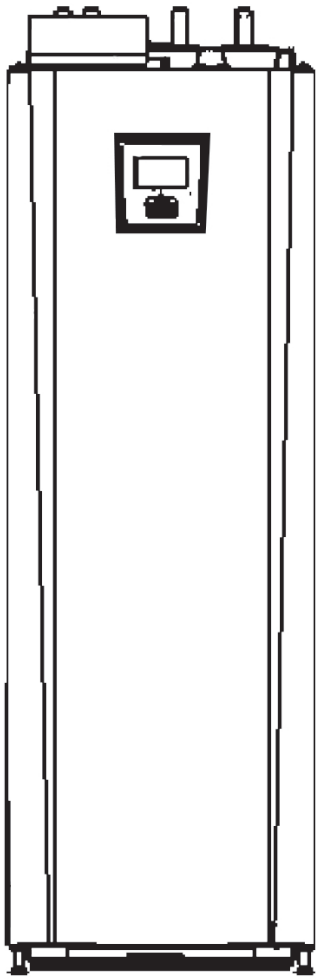

- 1. Cold water Ø22
- 2. DHW Ø22
- 3. Return Ø22
- 4. Primary flow Ø22
- 5. Expansion connection/ Lifting sleeve G 3/4"
- 6. Connecting air bleeding G 1/2"

2. Design

The picture below shows the fundamental construction of the heat pump.

The energy in the bore hole (bedrock) or ground is drawn up by the cooling system. The compressor then increases the temperature to a usable level. Afterwards it releases the energy for the heating circuit and DHW.

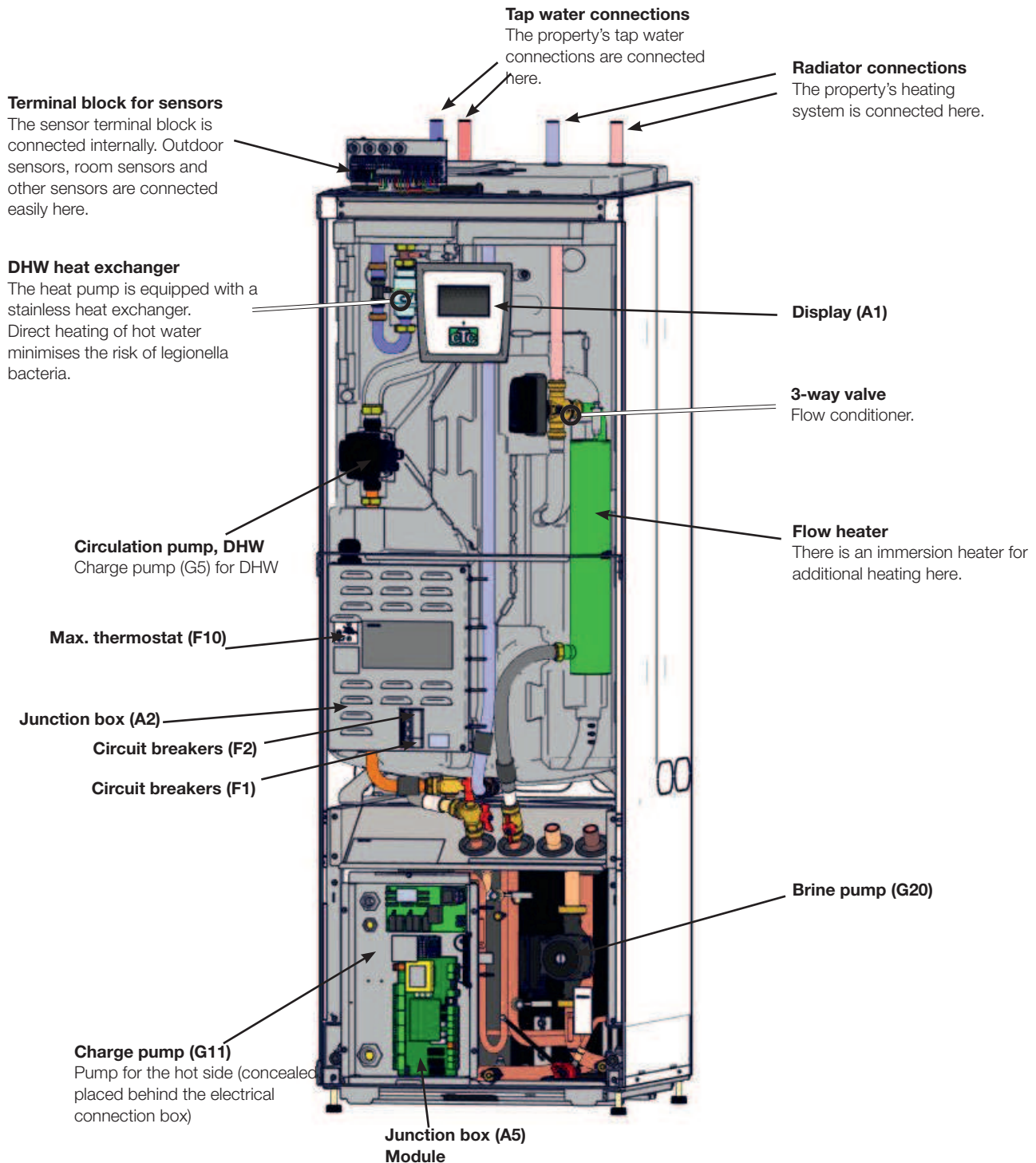

3. Parameter list

Heating circuit	Factory settings	User value
Max primary flow °C	60	
Min primary flow °C	Off	
Heating, mode	Auto	
Heating, mode, ext	Off	
Heating off, out °C	18	
Heating off, time	120	
Inclination °C	50	
Adjustment °C	0	
Night reduction disable °C	5	
Room temp reduced °C	-2	
Primary flow reduced °C	-3	
Alarm room temp °C	5	
Smart low price °C	1	
Smart over capacity °C	2	
Max time heating	20	
Charge pump %	60	
Drying period mode	Off	
Drying period temp °C	25	

Heat pump	Factory settings	User value
Tariff HP	Off	
Smart block HP	Off	
Start at degree minute	-60	

Electric heater	Factory settings	User value
Max el. heater kW	9.0	
Max el. heater DHW kW	0	
Start at degree minute	-500	
Diff step, degree minute	-50	
Main fuse A	20	
Input voltage	3x400V	
Tariff EL	Off	
Smart block immersion	Off	

DHW tank	Factory settings	User value
Stop temp °C		
Start/stop diff upper °C	5	
Max time DHW	30	
DHW °C		
Smart low price °C	10	
Smart overcapacity	10	
Runtime DHW-circ.	4	
Time DHW-circ.	15	
Timer WV-cirk.		

Cooling	Factory settings	User value
Common Heating and Cooling	Yes	
Condense Secured?	No	
Room temp cooling	25.0	
Smart low price °C	1	

Diff thermostat function	Factory settings	User value
Charge start diff temp °C	7	
Charge stop diff temp °C	3	
Charge temperature °C	60	

Pool	Factory settings	User value
Pool temp °C	22	
Pool diff °C	1.0	
Max time Pool	20	
Charge pump %	50	
Smart low price °C	1	
Smart overcapacity °C	2	

External heat source	Factory settings	User value
Charge start °C	70	
Start/ stop diff.	5	
Smart block cap.	Off	

Parameter list - Ventilation

Ventilation	Factory setting	Min value	Max value
Adjusted speed (RPS)	100	10	100
Forced speed (RPS)	80	10	100
Normal speed (RPS)	50	10	100
Reduced speed (RPS)	20	10	100
Run-on time (minutes), not Normal mode	30		10 hours
Night cooling	Turned off		
Start temp. diff. Inside/outside	3 °C	1	10
Stop temp. diff. Inside/outside	1 °C	0	10
Diff. inside/outside (hard-coded)	3 °C		
Weekly program	Off		

Parameter list - Solar panels

This page is only for solar panels settings.

Solar panels	Factory settings	User value
Charge start diff temp °C	7	
Charge stop diff temp °C	3	
Charge pump min %	20	
Sensor test active	No	
-Test/Paus, min	4 / 30	
-Winter break	No Nov- Feb	
Prioritize charging	EHS-tank	
Flow l/min	6.0	
Over temp protection panel	No	
-Max panel temp °C	120	
Cool over temp in tank	No	
-Tank cooled down to °C	50	
Antifreeze protection panel	No	
-Active when panel temp °C	-25	
Prioritize protection	EHS-tank	

Settings EHS-tank	Factory settings	User value
Charge temperature °C	60	
Maximum tank temp °C	70	

EcoTank	Factory settings	User value
Charge temperature °C	60	
Maximum tank temp °C	70	

X-volume	Factory settings	User value
Charge temperature °C	60	
Maximum tank temp °C	70	

Recharging of bedrock	Factory settings	User value
Recharging active	No	
-Charge start diff temp °C	60	
-Charge stop diff temp °C	30	
-Max brine temperature °C	18	

Charging EHS-tank	Factory settings	User value
Charge start diff temp °C	7	
Charge stop diff temp °C	3	
Charge tank temp °C	60	

4. Installation

This section is aimed at anyone responsible for one or more of the installations required to ensure that the product works the way the property owner wants.

Take your time going through functions and settings with the property owner and answer any questions. Both you and the heat pump benefit from a user who has completely understood how the system operates and should be maintained.

4.1 Transportation

Transport the unit to the installation site before removing the packaging. Handle the product in the following manner:

- Forklift
- Lifting eye that has been fitted to the lifting sleeve on top of the heat pump in the expansion connection.
- Lifting band around the pallet. **NB:** Can only be used with the packaging on.

Remember that the heat pump has a high centre of gravity and should be handled with caution.

4.2 Unpacking

Unpack the heat pump when it is placed next to its installation site. Check that the product has not been damaged in transit. Report any transport damage to the carrier. Also check that the delivery is complete according to the list below.

Included in the delivery:

- Heat pump CTC GS 6-8,
- Outdoor sensor
- 2 x brine hoses
- Installation and Maintenance Manual
- Safetyvalve for heating system, 2.5 bar (3)
- Safety valve for cold side, 3 bar
- 2 x cable ties
- 2 x support sleeves
- 2 x compression ring couplings for the brine hoses.
- Brine level vessel
- Filter ball valve, magnetite for heating system return flow
- Dirt filter for cold tap water
- Automatic vent valve (9)
- Pressure gauge (11)
- Manifold (8)
- Bushing 3/4"x3/8" (10)
- Bushing 1/2"x3/8" (12)

Accessories

- Filler manifold brine
- Room sensor
- Cover

! The product must be transported and stored in an upright position.

! As the cooling module is removable, there must be a free space of at least one metre in front of the product and it must not be placed below floor level either.

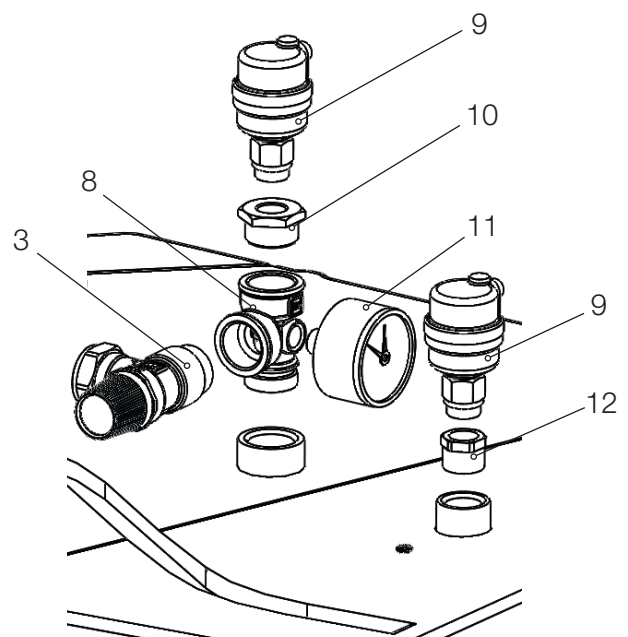

4.3 Control functions (std.) and with Expansion Card

The product is supplied from the factory with control functions according to “Basic functions” below.

Supplementing with the expansion card accessory (A3) adds solar control and its variants as well as bore hole recharging and various tanks. In addition, hot water circulation and pool control are also included.

Basic functions

(built into the factory version)

- Heating System 1
- Heating circuit 2*
- EHS tank*
- Diff thermostat*
- Cooling*
- CTC SMS*
- Remote control
- Smart Grid

* Requires accessories such as: Extra sensor, mixing valve group 2, etc.

Functions with expansion card (A3)

(accessory)

- Solar control
- Hot water circulation
- Pool

5. Pipe installation

The installation must be carried out in accordance with current standards and regulations. Refer to MIS 3005 and associated building regs Part L, F & G. The product must be connected to an expansion vessel in an open or closed system. **Do not forget to flush the heating circuit clean before connecting.** Apply all the installation settings based on the description in the section entitled "First start".

5.1 Schematic diagram

This shows the main connection between the heat pump and the property's heating and water supply system. Different installations and systems may look different, e.g. a one or two-pipe system, which means that the finished installation may be different. To find out about connecting the cold side, see the section entitled "Connecting the brine system".

■ Heating circuit 2 can only give the same temperature as heating circuit 1 or a lower temperature.

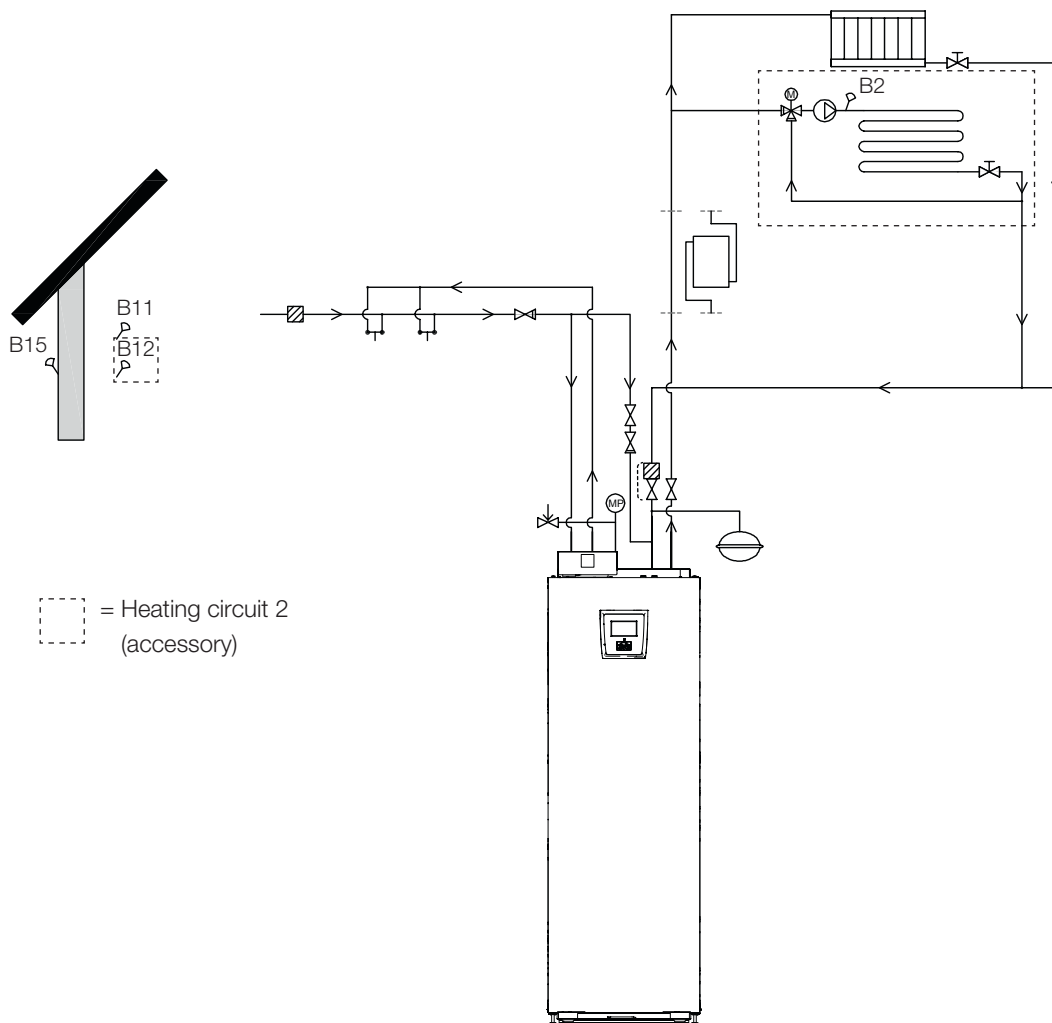

5.1.1 Filling valve, heating circuit

Fit a filling valve between the cold water connection and the heating circuit's return flow.

5.1.2 Non return valve

Fit the non-return valve to the incoming cold water connection.

5.1.3 Shut-off valves

It is important to fit a shut-off valve (94) to the primary flow.

The filter ball valve (95) provided should be fitted to the heating circuit's return flow.

5.1.4 Safety valve

The heat pump's safety valve (2.5 bar) for the heating circuit must be fitted in accordance with applicable regulations. Connect the waste pipe to the waste system directly to the floor drain or, if the distance is more than two metres, to a funnel. The waste pipe must slope towards the waste system, be installed frost-free and left open to the atmosphere/without pressure.

5.1.5 Manometer – system pressure

Fit a manometer to the expansion pipe or the heating circuit's return line.

 NB: The waste pipe must be fitted to the waste system.

 NB: It is important to fit shut-off valves to both the primary and return flows.

5.1.6 Connection of expansion tank (accessory)

The heat pump is best connected to a closed expansion vessel. The heat pump is ready to be fitted to an 18 l closed expansion vessel, positioned on top of the product. The expansion tank with the required hose and connectors is available as an accessory.

If you use an open system, the distance between the expansion vessel and the highest placed radiator must not be below 2.5 m in order to avoid introducing oxygen into the system.

If the heat pump is connected together with another heat source, e.g. an existing boiler, the installations must have separate expansion vessels.

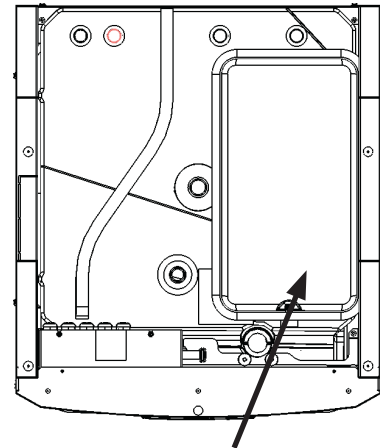

Position of expansion tank.

5.1.7 Expansion tank pre-pressure

The pre-pressure in the expansion tank is calculated according to the height (H) between the highest-positioned radiator and the expansion tank. The system pressure must be set 0.3 bar higher than the pre-pressure in the expansion tank. For example, a pre-pressure of 1.0 bar (5 mvp) means a maximum permitted height difference of 10 m.

Maximum height (H) (m)	Pre-pressure (bar)	System pressure (bar)	Maximum volume in the heating circuit (excl. product) (L)
5	0.5	0.8	310
10	1.0	1.3	219
15	1.5	1.8	129

The table assumes installation with expansion tank (included in accessories CTC Installation kit GS).

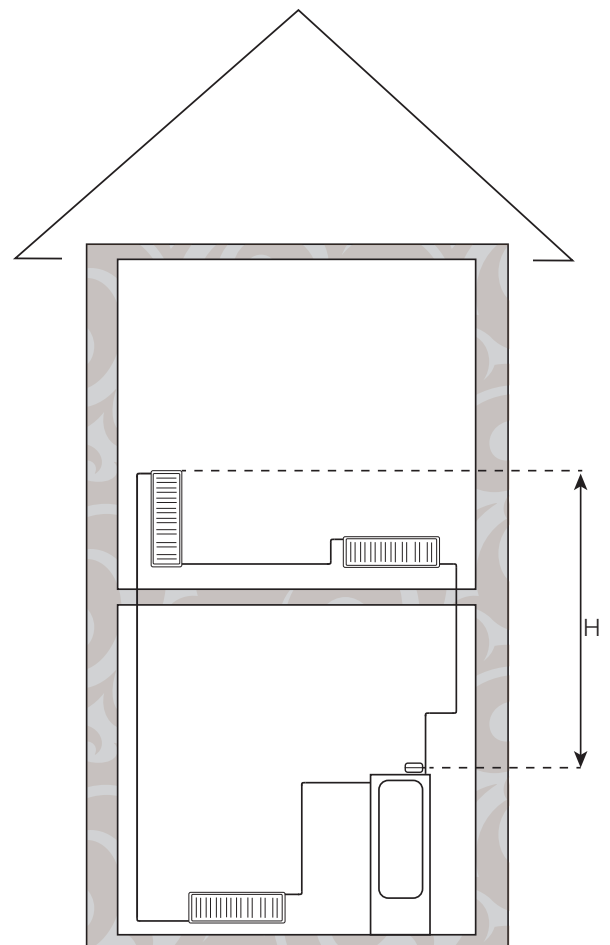

5.1.8 Pressure differential diagram CTC GS 6-8 – hot side

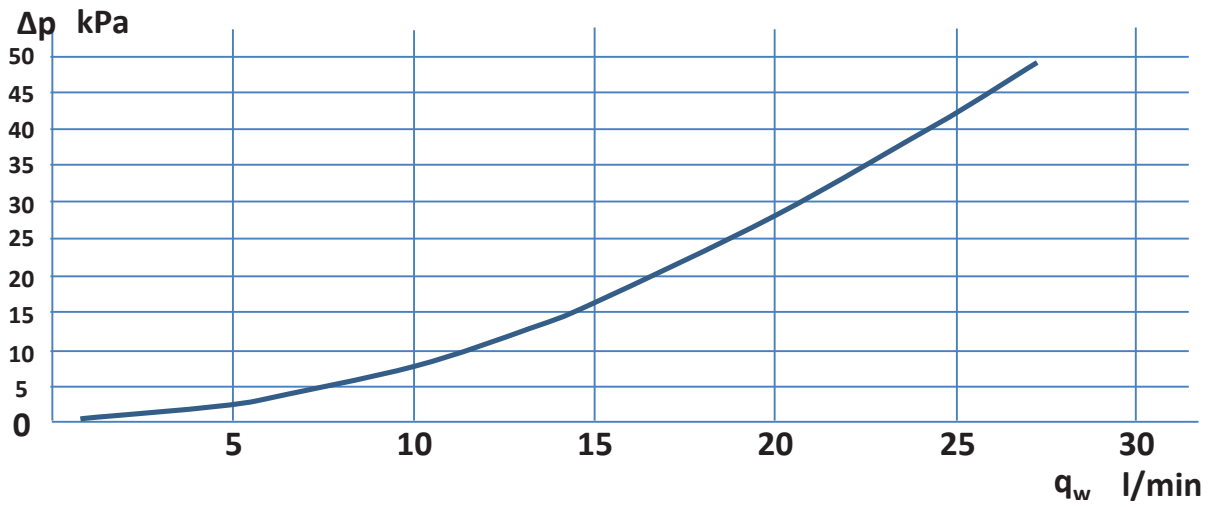

5.1.9 Heat medium pump (G11)

Yonos Para SO 25/7.5 PWM1 130

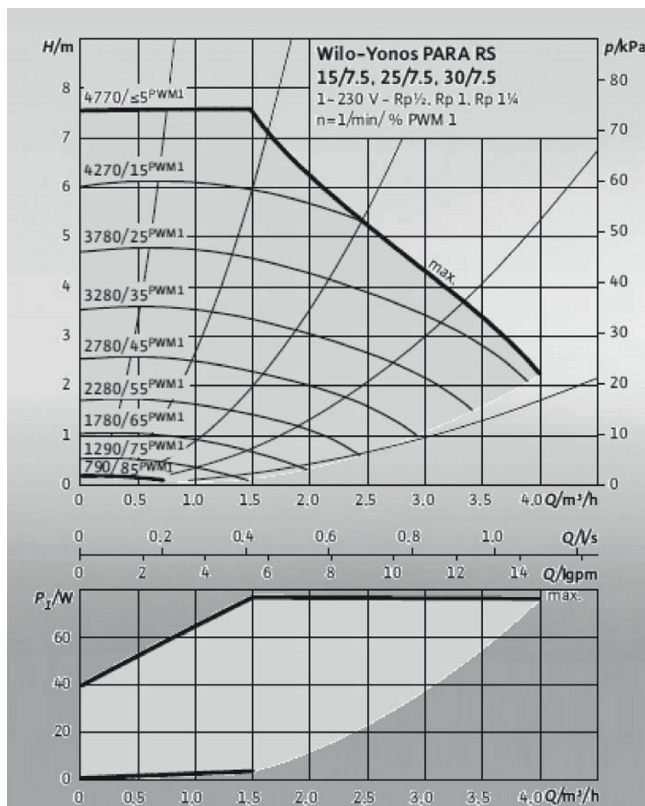

5.1.10 Electric shut-off valve Y47

If you have two heating circuits and wish to have background heating in heating circuit 2 and the heat off during the summer in heating circuit 1, you can use an electric shut-off valve (Y47). Terminal block A13 is powered during the heating season and not powered in the summer.

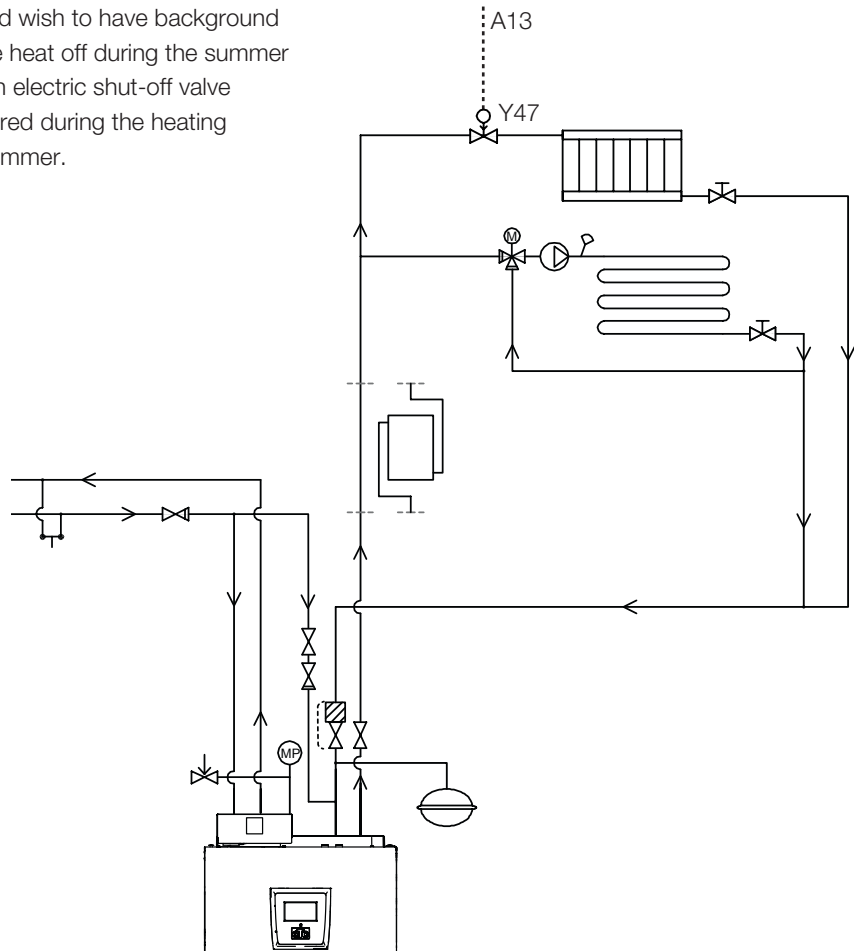

5.1.11 DHW circulation (accessory)

The settings for hot water circulation require the installation of an expansion card accessory.

DHW circulation is connected as shown in the schematic diagram. Pump G40 is used to circulate the hot water.

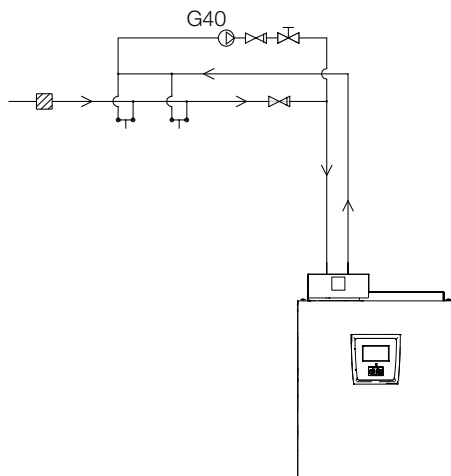

5.1.12 External heat source (EHS)

This function is used to connect additional heat sources to the heating circuit, e.g. water-jacketed stove, solar heat.

The heat from the external heat source is diverted into the system when the set temperature in the external tank is reached, and is at least 5°C higher than the setpoint. Diversion stops when the temperature is 3°C higher. The compressor and immersion heater stay idle for as long as there is sufficient energy in the external heat source. Heat is diverted to both the heating circuit and to hot water.

This comes to an end when one of the following alarms occur: Primary flow sensor 1, HP in-sensor, Comm. error HP or if Primary flow sensor 1 is hotter than 80 °C.

Enter settings under Settings/External heat source.

NB: When an external heat source is connected to the heat pump, a magnetic filter should be fitted on the return flow between EHS and the heat pump to protect the heat exchanger.

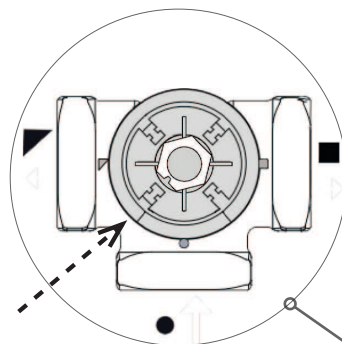

Three-way mixing valve VRG 131

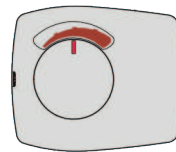

The mixing valve motor ARA 671 is mounted on the valve with the knob in the centre position. The motor must move in an anticlockwise direction to close.

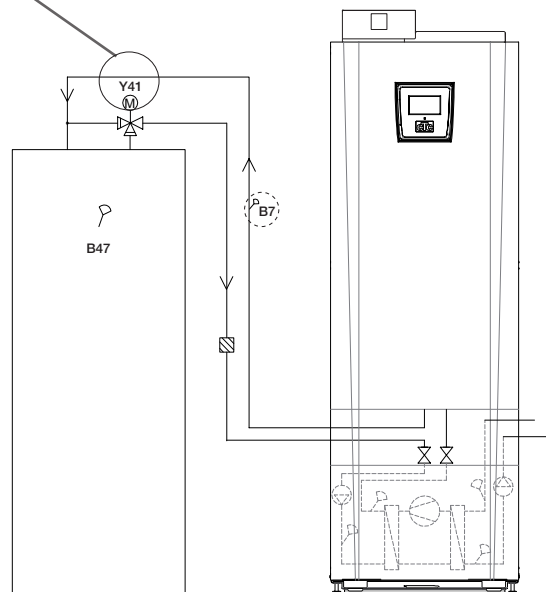

5.1.13 Diff thermostat function

The diff thermostat function is used if you want to transfer heat from a tank with the sensor (B46) to a tank with the sensor (B47).

The function compares the temperatures in the tanks and, when it is warmer in the first tank (B46), charging starts to the second tank (B47).

NB: For certain heat sources, e.g. solid fuel boilers, automatic chargers are recommended, among other things to counteract condensation in the fire box.

However, this function cannot be combined with solar system 2 with EcoTank. This is because the same circulation pump (G46) is used.

Ensure a high flow on the pump (G46) so that a low temperature difference of approx. 5–10°C is achieved over the EHS tank during charging.

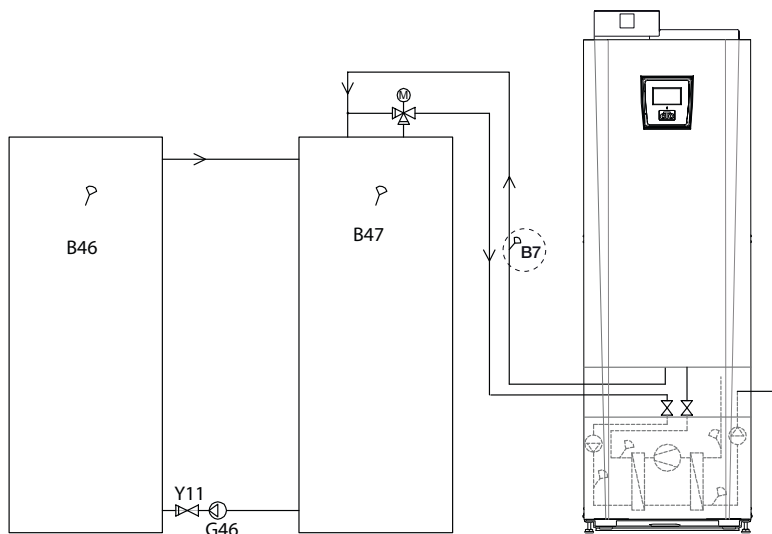

Operation data displays the information "Ext. tank pump/°C".

5.1.14 Pool (accessory)

A pool can be connected to the system using a diverting valve (Y50). A heat exchanger should be fitted to separate the liquids.

When the pool is heated, the diverting valve (Y50) changes direction and the pool pump (G51) starts.

The immersion heater is never used to heat the pool.

When a constant flow is desired in the pool water, the pool pump (G51) is connected with a separate supply and constant voltage.

The expansion card accessory is required to connect pool heating to your heating circuit.

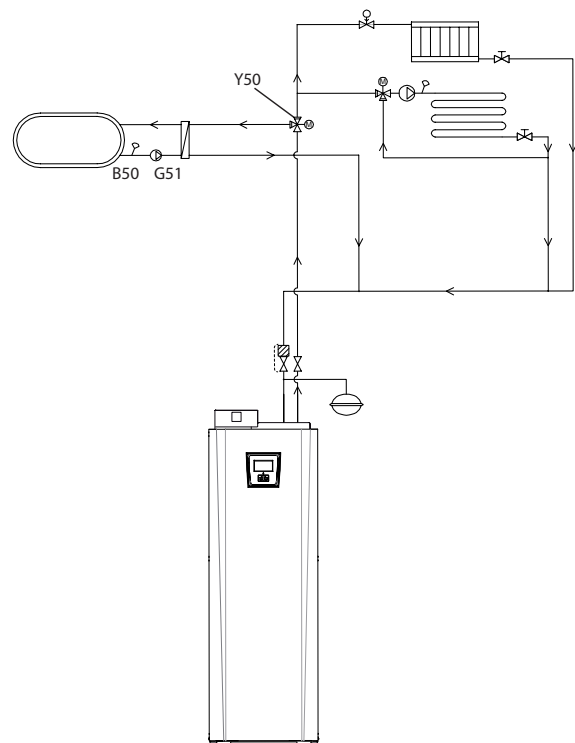

5.1.15 Solar heat (accessory)

Solar heat is connected to the system through an external heat source tank (EHS-tank).

The number of solar panels which can be connected depends on the volume of water in the product/tanks to which the solar panels are to be connected.

System 1

System 1 is a system structure with solar heat going directly to an external heat source tank (EHS-tank).

Charging conditions (main conditions, factory settings)

Charging starts when B31 is 7°C warmer than B47.

Charging stops when there is a difference of 3°C between B31/B30 or when the charge temperature is reached.

The external heat source tank (01) may also have a solar coil; this means that the heat exchanger (F2), pump (G32) or non-return valve (Y11) is not required.

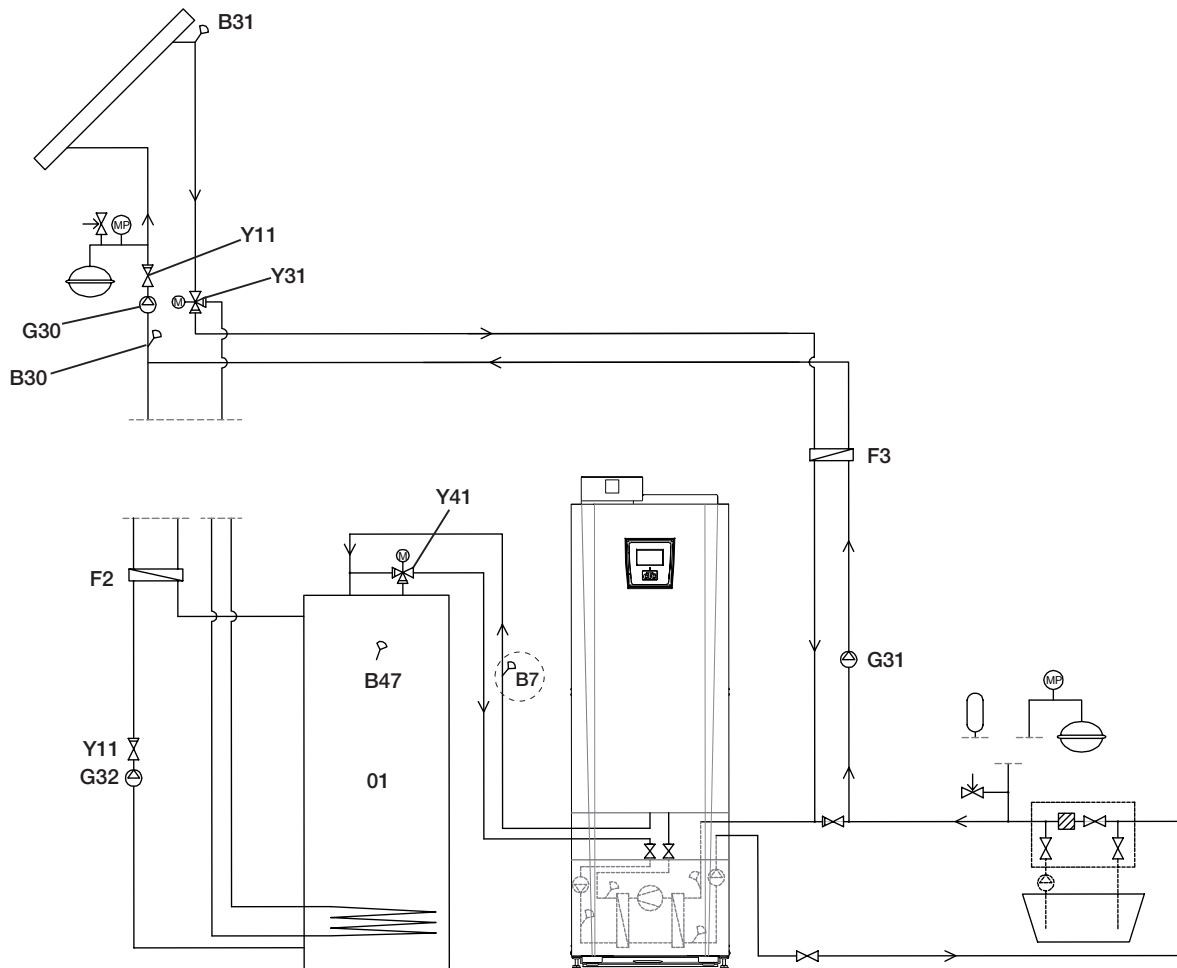

Schematic diagram only The installation engineer fits expansion tank, safety valves, bleeders, etc. and sizes the system.

System 2

System 2 is a system structure with solar heat connected to an external heat source tank (EHS-tank) and an extra buffer tank (CTC EcoTank for example). The system allows for a larger solar collector surface since it carries a greater volume of water.

Charging conditions

Charging starts when B31 is 7°C warmer than B42.

Buffer tank **without** coil:

Charging stops when there is a difference of 3°C between B31/B30 or when the charge temperature is reached.

Buffer tank **with** coil:

For a tank with a solar coil, the charging stops instead when B31 is 3°C warmer than B42.

Charging of the EHS tank compares sensor B41 to sensor B47.

The buffer tank (O2) may also have a solar coil; this means that the heat exchanger (F2), pump (G32) or non-return valve (Y11) is not required.

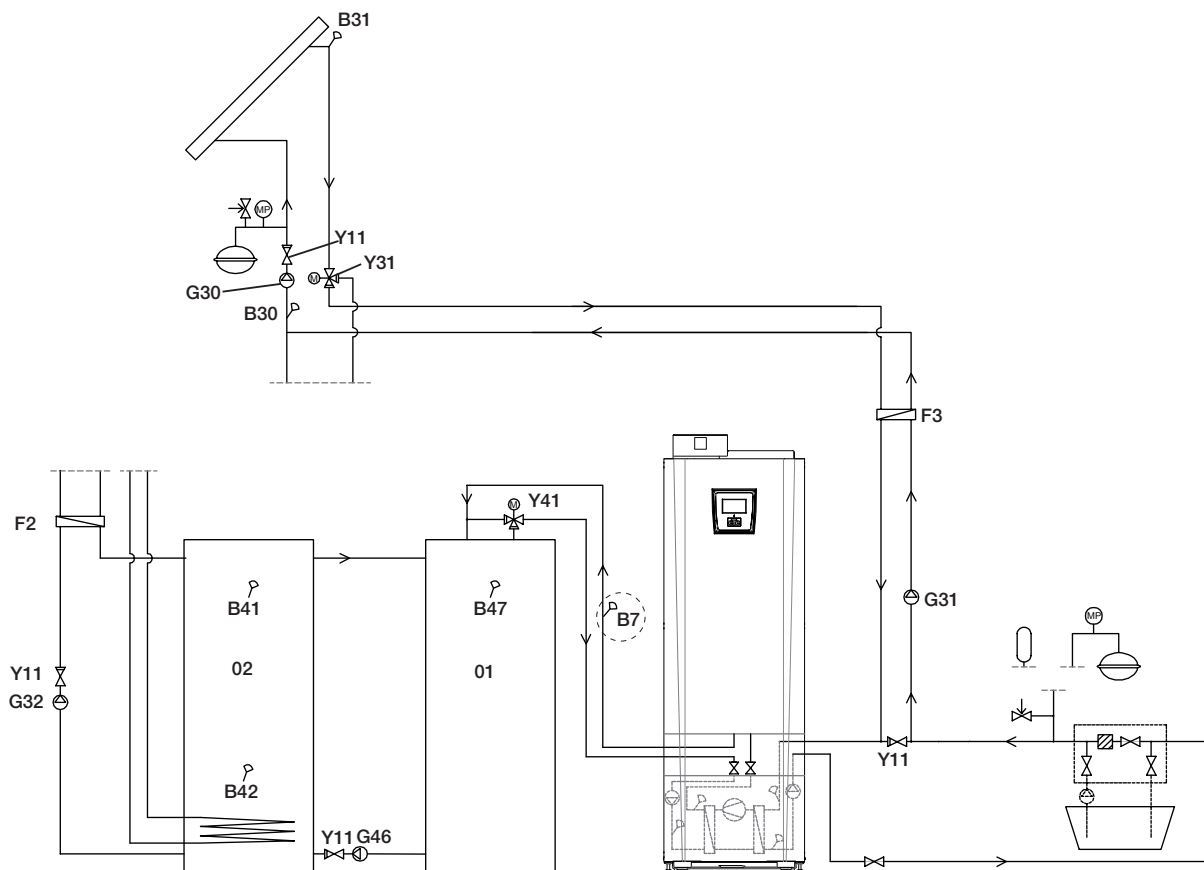

Schematic diagram only The installation engineer fits expansion tank, safety valves, bleeders, etc. and sizes the system.

System 3

System 3 is a system structure with an extra volume called O3; this can be a large extra tank or a pool. The greater the volume of water, the greater the solar collector surface.

Solar heat is connected to an external heat source tank (EHS-tank) and an extra buffer tank (CTC EcoTank for example). The system allows for a larger solar collector surface since it carries a greater volume of water.

Charging conditions

Charging starts when B31 is 7°C warmer than B42 or B47.

Charging stops when there is a difference of 3°C between B31/B30 or when the charge temperature is reached.

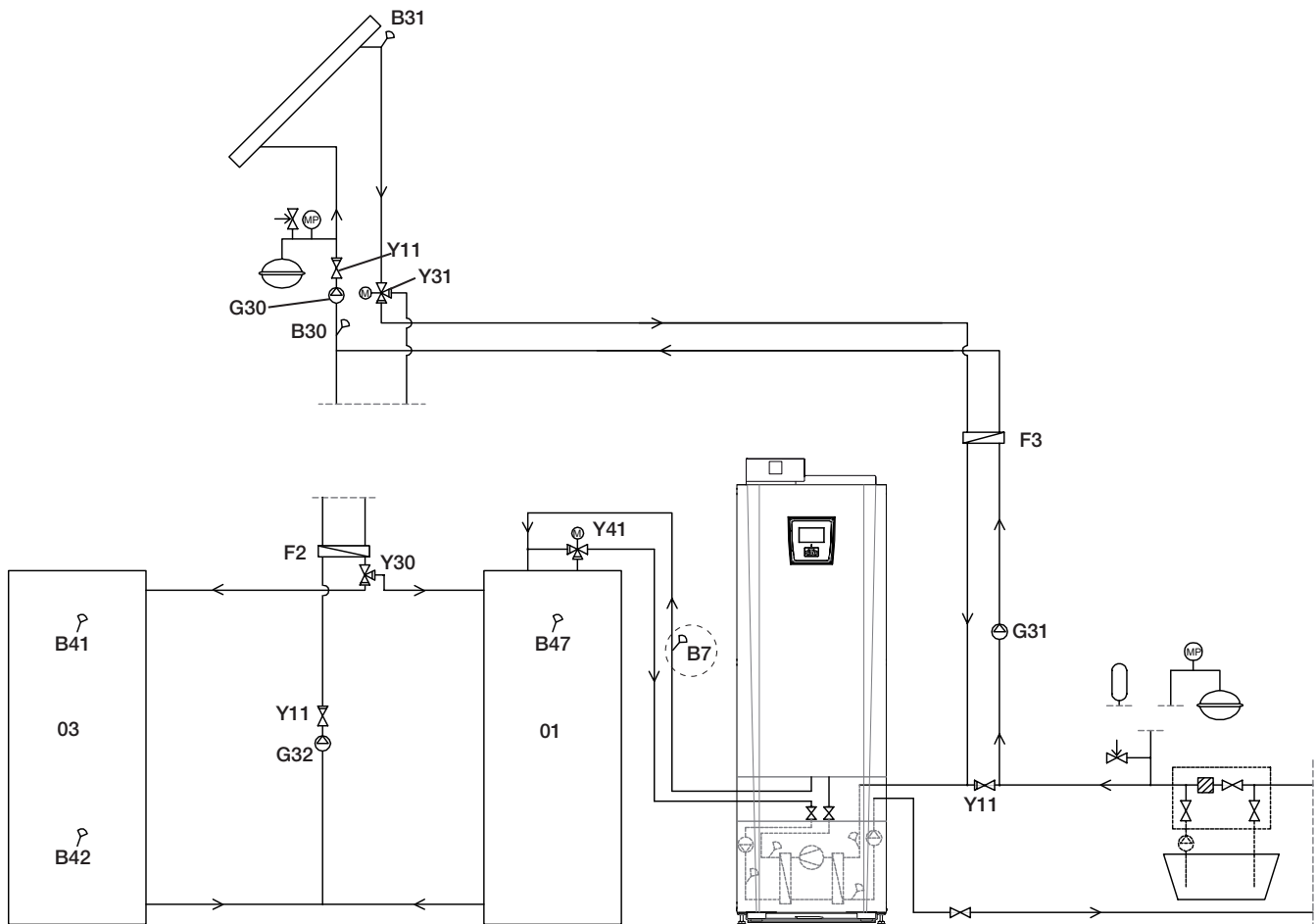

Schematic diagram only The installation engineer fits expansion tank, safety valves, bleeders, etc. and sizes the system.

5.1.16 Schematic diagram (full diagram)

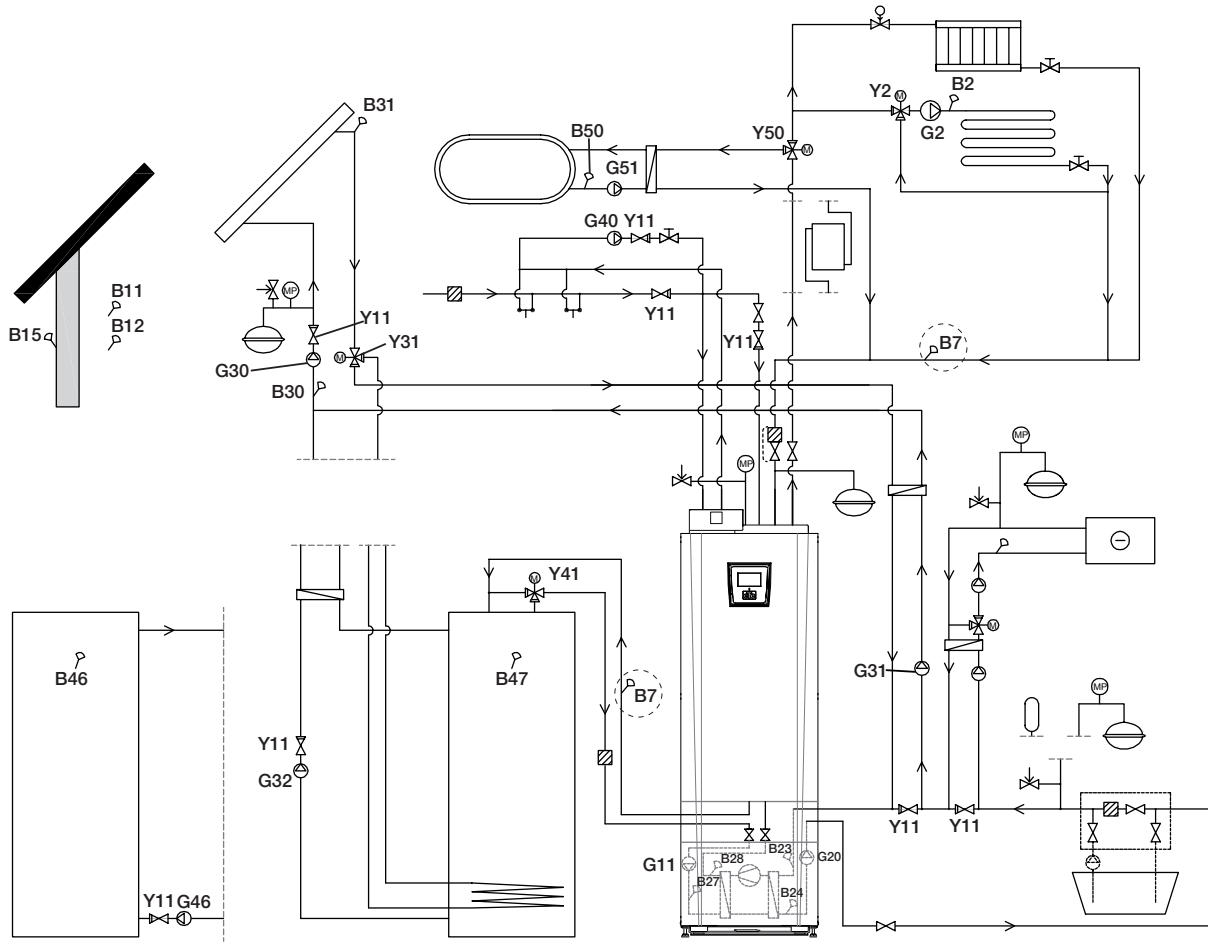

6. Connecting the brine system

The brine system, i.e. the ground collector loop, must be assembled and connected by a qualified tradesman in accordance with current regulations and design guidelines.

Care must be taken to ensure that no dirt gets on the collector hoses, which must be washed clean before being connected. The protective caps must remain in place at all times while work is in progress.

The temperature of the coolant system can fall below 0°C. It is therefore important that water-based lubricants, etc. are **not** used during installation. It is also important that all the components are insulated against condensation to prevent the build-up of ice.

6.1 Connections

The brine system may be connected to the right, left or back of the heat pump. Cut away the cover plate on the side where the brine system is to be connected. The insulation on the inside of the cover plate has been grooved to enable an opening to be cut for the brine hoses provided. When the opening has been made through both the insulation and cover plate, carry out the installation as follows:

1. In order to protect the brine hoses, fasten the protective edging provided around the edge of the opening in the insulation plate. Adjust the length of the protective edging to suit the opening as required.
2. Attach the provided compression couplers to the cooling module connector pipes. To facilitate attachment, the upper brine pump connection may be loosened and rotated if necessary.
3. Pass the brine hoses through the opening in the side cover plates and connect them to the compression couplers. Ensure that the connections are well insulated to avoid the build-up of ice and condensation.
4. Install the collector system after this according to the schematic diagram.

You can also connect the primary flow on one side and the return on the other. See the section entitled “Measurement details for measurements and dimensions”. The pipe between the heat pump and collector loop should have an internal diameter of no less than Ø28 mm.

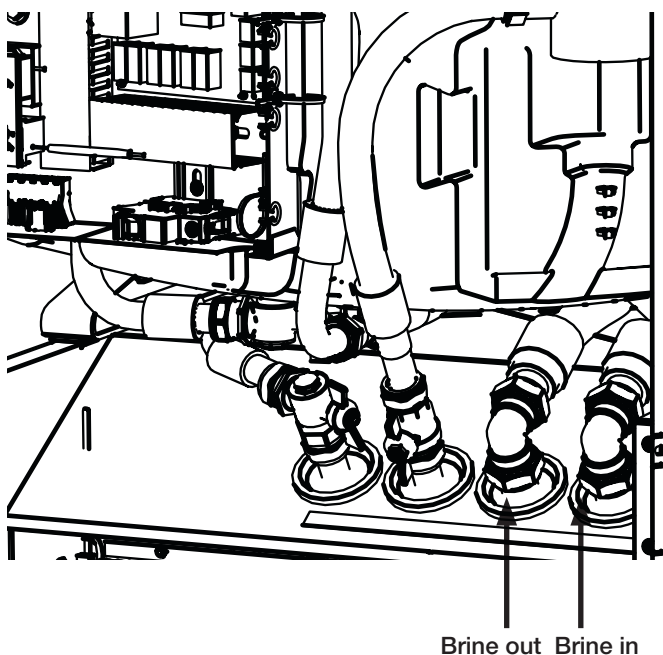

6.1.1 Connection options

Left-side installation

1. Use the rear through-hole
2. Push in the "brine out" hose from the side
3. Pull out the hose from the front while pushing in the hose from the side
4. Fit the "brine in" hose
5. Push in the hose from the side
6. Pull out the hose from the front while pushing in the hose from the side
7. Fit the "brine out" hose.

If the hose is pulled out from the front without pushing it in from the side at the same time, the hose will be wedged with the insulation stuck under the tank and the insulation could be ruined.

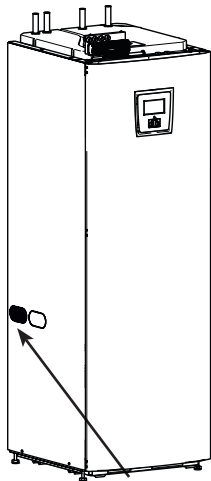

Left-side connection
(Use rear outlet)

Right-side installation

1. Use the front through-hole
2. Fit the "brine out" hose
3. Fit the "brine in" hose

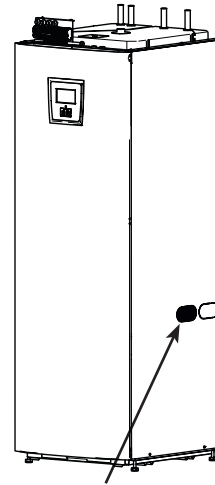

Right-side connection
(Use front outlet)

Rear installation

1. Use through-hole A
2. Fit the "brine out" hose
3. Push the hose to the side under the tank
4. Fit the "brine in" hose

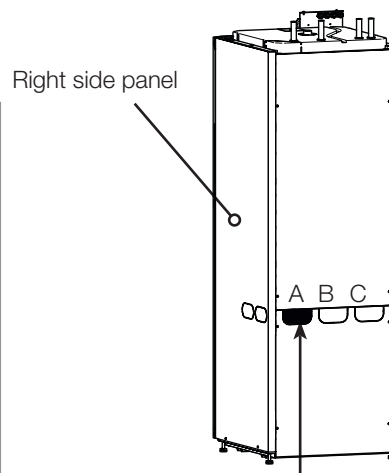

Rear connection
(Use outlet A)

6.1.2 Valves

Fit the valves as shown in the schematic diagram on the next page. To facilitate servicing of the cooling unit, shut-off valves must be fitted to both the incoming and outgoing connections. Fit bifurcated valves so that it is possible to fill and bleed the collector circuit later on.

6.1.3 Insulation against condensation

All pipes in the brine system must be insulated against condensation to prevent the possibility of severe build-up of ice and condensation.

6.1.4 Filling and venting

The collector coil should not contain any air as even the smallest amount of air can jeopardise the heat pump's operation.

Mix water and antifreeze solution in an open vessel. Connect hoses to the shut-off valves (98a and 98b) as shown in the figure. NB: The hoses must have a minimum diameter of 3/4". Connect a powerful external pump (100) for refilling and bleeding. Open the valves (98a and 98b) so that the brine passes through the mixing container (101). Also make sure that the valve (98d) is open.

If the heat pump is connected to the power supply, start the brine pump (102) as follows:

- Go to the menu Installer/Service/Function test.
- Select the Brine pump option and activate it. The brine pump runs until it is manually stopped.

Allow the brine to circulate in the system for a long period of time until it is completely free of air. There could still be air in the system, even though no air accompanies the liquid out.

Bleed the level vessel (96) by loosening the plug on the top of the level vessel.

Now close the valve (98a) while the filling pump continues to run. The filling pump (100) now pressurises the system. Also close the valve (98b) and shut off the filling pump.

If the level in the level vessel is too low, close the valves (98c) and (98d).

Unscrew the plug and fill the vessel to around 2/3 full. Screw the plug back in and open the valves (98c) and (98d).

6.1.5 Pressure/level switch

In some cases, extra protection is required due to local requirements or provisions. For example, the requirement in some areas is for the system to be installed within a water catchment area. If there is a leak, the compressor and brine pump stop and the Flow/level switch alarm appears on the display. For connection, see the section entitled "Electrical installation".

■ Use the "Brine pump on 10 days" function to bleed the system properly.

6.2 Brine system schematic diagram

- 96 Level/expansion vessel
- 97 Filler manifold
- 98 Shut-off valves
- 99 Filter
- 100 External filling pump
- 101 Mixing vessel
- 102 Brine pump
- 103 Evaporator
- 104 Safety valve 3 bar

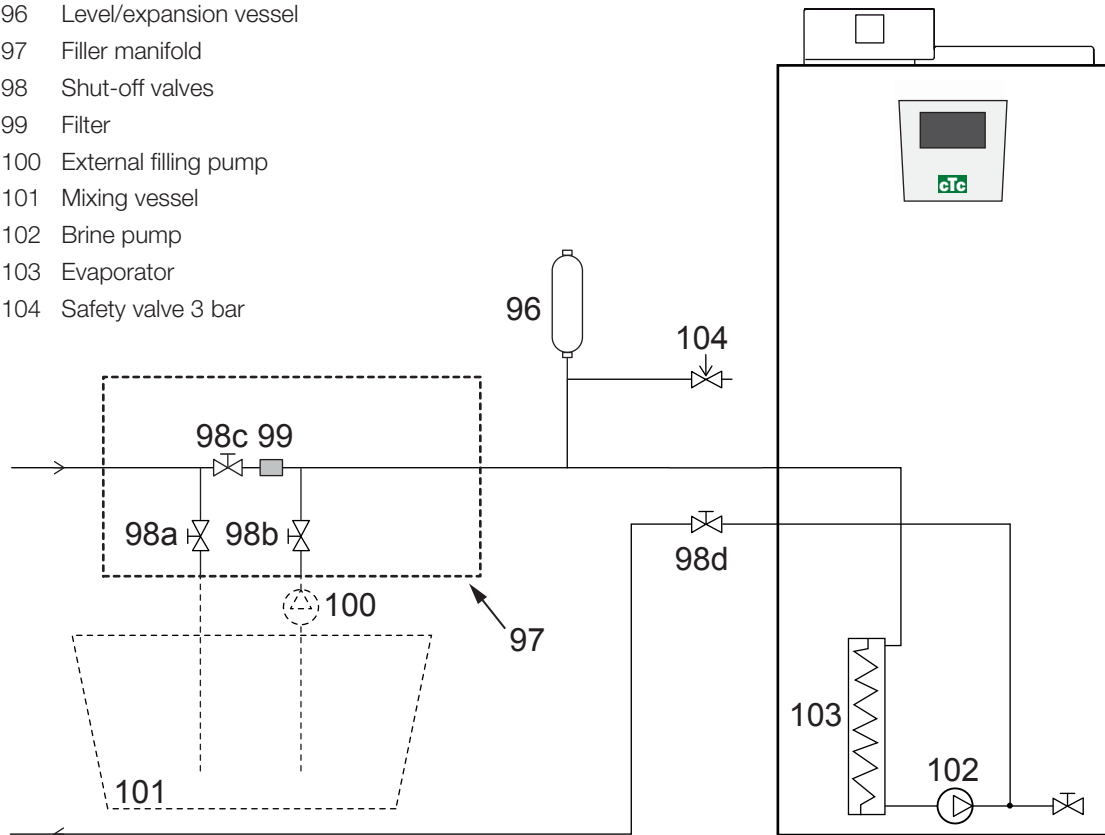

The diagram shows the main connection for the brine system. The filling equipment is represented by the parts displayed with dashes. NB: Collector hoses must have a bleeding facility as air pockets can occur. Always check the filter (99) when filling and bleeding the brine system.

6.2.1 Post-installation check on brine system

After a few days, you must check the fluid level in the vessel. Fill if necessary and close the valve (98c) when filling.

6.2.2 Level/expansion vessel (96)

The level vessel should be fitted to the incoming line from the borehole or ground loop, at the system's highest point. Bear in mind that the tank can produce condensate on its exterior. Fit the safety valve (104) as shown in the schematic diagram and fit a suitable plug to the top of the vessel.

If the vessel cannot be fitted at the highest point, a closed expansion vessel can be fitted.

6.2.3 Filler manifold with dirt filter (accessory)

A filler manifold for topping up, adding and filtering brine. Arrows on the valve housing indicate the flow direction. Close valves (98c) when cleaning the filter. Unscrew the filter cap and flush the filter clean. When refitting, the pin under the filter should be fed into the designated hole in the filter housing. Top up with a little brine, if necessary, before fitting the cap. The filter should be checked and cleaned after a short period of operation.

! The mixing vessel and pump must be of a good size.

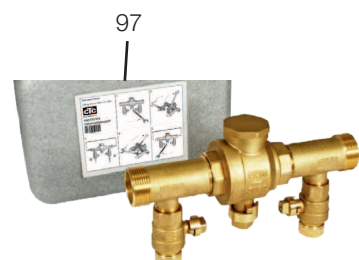

6.2.4 Brine

The brine circulates in a closed system. The fluid consists of water and antifreeze solution. Sentinel R500 & R500C are recommended for use in the brine circuit. The glycol is mixed at a concentration of slightly less than 30%, which is equivalent to fire risk class 2b and a freezing point of around -15°C .

It is a CTC recommendation that around 1 litre of brine/glycol is required per metre of collector hose, i.e. around 0.3 litres of antifreeze solution will be needed per metre of hose, for an (external) hose diameter of 40 mm.

6.2.5 Air pockets

To avoid air pockets, make sure that the collector hoses constantly rise towards the heat pump. If this is not possible, it must be possible to bleed the system at the high points. The filling pump usually manages smaller local height discrepancies.

6.2.6 Checking brine difference

When the heat pump is running, regularly check that the temperature difference between incoming and outgoing brine temperatures is not too large. If there is a large difference, one of the causes may be due to air in the system or a blocked filter. If this is the case, the heat pump triggers the alarm.

The alarm factory setting is 7°C , but 9°C is permitted for the first 72 hours while the compressor is running, as microbubbles in the system can reduce brine flow.

6.2.7 Groundwater heating

Groundwater can also be used as a heat source for CTC's heat pumps. The groundwater is pumped up to an intermediate heat exchanger that transfers the energy to the brine liquid. It is important that an intermediate heat exchanger is installed in the system. The intermediate heat exchanger prevents the product's evaporator from becoming damaged due to deposits from groundwater particles and minerals, which could otherwise involve expensive work on the product's refrigerant system. Water requirements analysis should always be undertaken for intermediate heat exchangers. Local regulations and permit requirements must be taken into account.

The return water is discharged elsewhere, to a drilled return flow well or similar.

The brine pump (G20) and groundwater pump must be connected to run simultaneously in order to prevent freezing.

 Check the dirt filter after bleeding has been completed.

 The fluid must be thoroughly mixed before the heat pump is started.

 Check the dirt filter in the brine system after a few days' operation.

6.3.1 Pressure differential diagram CTC GS 6-8 – cold side

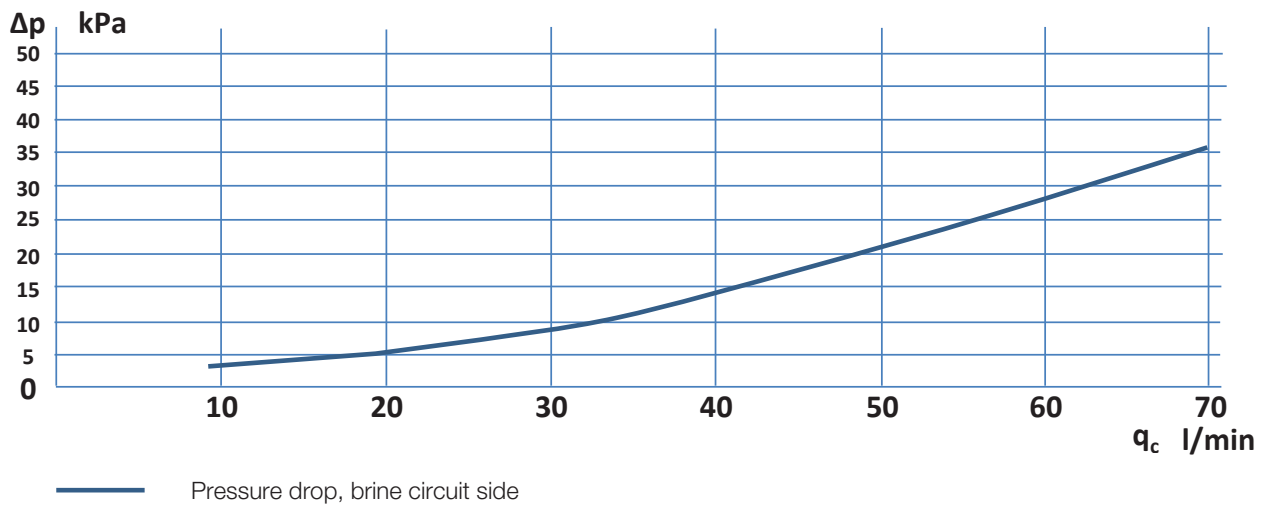

6.3 Coolant pump (G20)

Cirkulationspumparna i CTCs produkter är av energieffektivitetsklass A.

UPMXL GEO 25-125 180 PWM, 1x230 V, 50/60 Hz

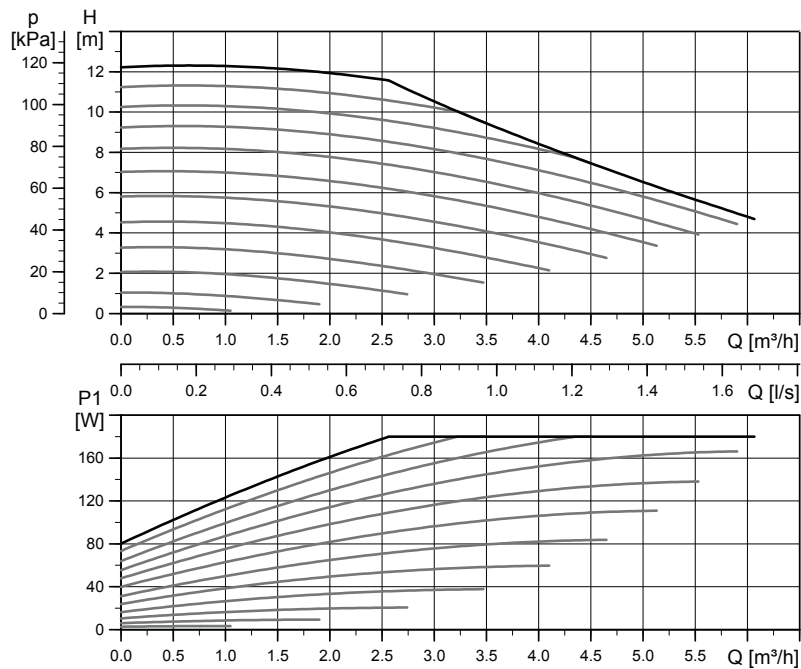

7. Electrical installation

Safety information

The following safety instructions must be observed when handling, installing and using the product:

Turn off the power with an omnipolar switch before doing any work on the product.

- The product is classified as IPX1. The product must not be rinsed with water.
- Never jeopardise safety by removing bolted covers, hoods or similar.
- Never jeopardise safety by deactivating safety equipment.
- Damaged feed cables must be replaced by the manufacturer or a qualified service engineer in order to avoid any risks.
- Installation and heat pump connection must be performed by an authorised electrician. All wiring must be installed according to applicable provisions. The boiler comes pre-wired from the factory and set at 9.0 kW electrical power for heating and 0.0 kW electrical power for hot water.

To open the front panel, loosen the two screws at the top, fold out and set the front aside. Bear in mind that the cable to the display on the front is sensitive to damage.

Supply

The power supply cable is connected at (1). Length 200 cm. The minimum group fuse size is specified in “Technical data”.

Omnipolar safety switch

The installation should be preceded by an omnipolar safety switch according to overvoltage category III, which ensures disconnection from all electric power sources.

Residual current device

If there already is a ground fault breaker, the product must also be fitted with its own ground fault breaker with on/off delay.

Max thermostat

If the product has been stored in an extremely cold place, the max. thermostat may have been triggered. Reset it by pressing in the button on the electrical switchboard behind the front panel. Always check on installation that the max thermostat has not tripped.

Extra low voltage protection

The following outputs and inputs have extra low voltage protection: current transformer, outdoor sensor, room sensor, primary flow sensor, return sensor, NR/SO.

Accessory: expansion card (A3)

For certain system options the product must be supplemented with the expansion card accessory (A3). See the manual provided for how to install the card. Settings which are entered after installation are found in this manual.

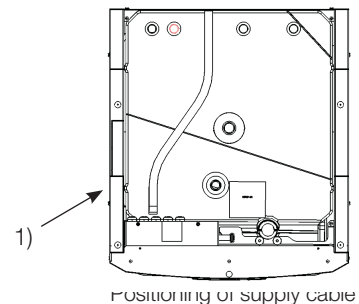
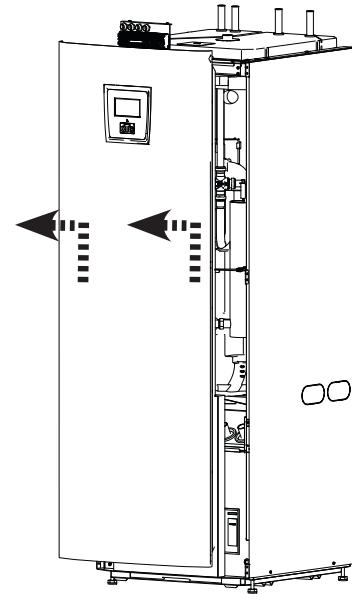

Symbol for max thermostat:



7.1 Sensor connection

Sensor connection is carried out on top of the main product.

Sensor terminal block

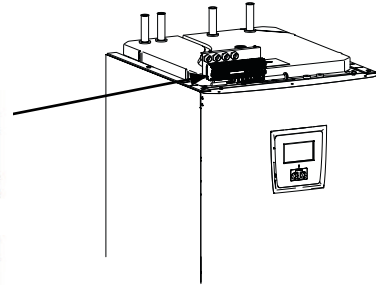
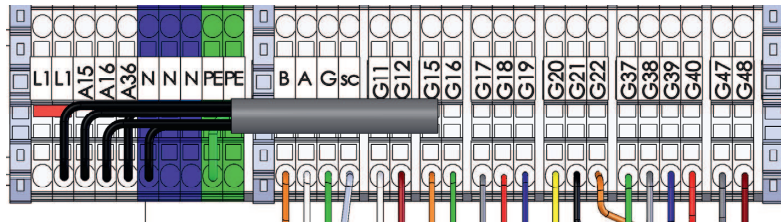

Connection of outdoor sensor (B15)

The outdoor sensor is connected to G11–G12 on the sensor terminal block.

The sensor should be set up on the house's northwest or north side, so that it is not exposed to morning and evening sun. If there is a risk of the sensor being affected by the sun's rays, it must be protected by a screen.

Place the sensor at around 2/3 of the height of the facade near a corner, but not under a roof projection or other form of wind protection. Do not place it either above ventilation ducts, doors or windows where the sensor may be affected by factors other than the actual outdoor temperature.

Do not attach the sensor cable permanently until you have tested where the best location is.

Connection of room sensors (B11 and B12 - accessories)

Room Sensor 1 connected to G17-G19.

Room Sensor 2 connected to G20-G22.

The room sensor is fitted at a central point in the house, in the most open position possible, ideally in a hall between several rooms. This is the best position for the sensor to record an average temperature for the house.

Feed a three-conductor cable (minimum 0.5 mm²) between the heat pump and room sensor. Then attach the room sensor securely in a position roughly two thirds of the way up the wall. Connect the cable to the room sensor and heat pump.

When connecting a wireless room sensor (accessory), refer to the accessory's manual.

Check room sensor connection

- Go to the menu: *Installer/Service/Function test/Heating system*.
- On line *Diode room sensor*, press OK.
- Select *On* using the + button and press OK. Check that the room sensor LED lights up. If not, check the cables and connection.
- Select *Off* using the - button and press OK. If the OK LED goes off, the check is complete.
- Return to start menu by pressing the Home button.

Room sensor 1 (B11)

Sensor terminal block	Terminal block, room sensor
G17	#1 (alarm)
G18	#2
G19	#4

Room sensor 2 (B12)

Sensor terminal block	Terminal block, room sensor
G20	#1 (alarm)
G21	#2
G22	#4

7.2 Checking connected sensors

If any sensor is incorrectly connected, a message will appear on the display, e.g. "Alarm: [E030] sensor out". If several sensors are incorrectly connected, the different alarms are displayed on different rows.

If no alarm is displayed, the sensors are connected correctly.

7.3 Pressure/level switch

The pressure/level switch is connected to blocks G73 and G74 and then defined under the Installer/Define system/Def Heat pump menu.

7.4 Installing a backup power supply

The DIP switch on the relay card (A2) is used to set the backup power supply. The DIP switch is marked "RESERV" (BACKUP).

When the switch is set to ON, the step is actively operating in backup heating mode.

Factory-set value 2.1 kW divided across 3x400 V. Set the value according to the requirements and capacity of the property.

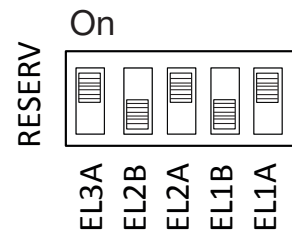

Example for $1.2+0.6+0.3 = 2.1$ kW.
(Factory-set value)

3x400 V

Relay	EL3A	EL2B	EL2A	EL1B	EL1A
Factory setting	ON	OFF	ON	OFF	ON
Current	5.2 (A)	10 A	2.6 A	10 A	1.3 A
Output	1.2 kW	2.3 kW.	0.6 kW.	2.3 kW.	0.3 kW.

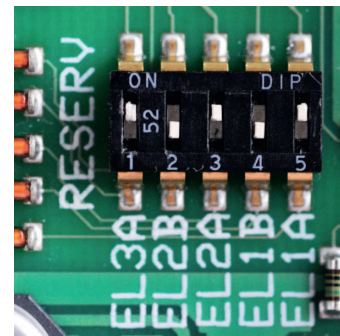

7.5 Pump Diff thermostat function (G46) on/off

230 V 1N~

Sensor (B46) is connected to the relay card (A2) at terminal block G65–G66.

Circulation pump G46 is connected to the following terminal blocks:

Phase:	brown	Terminal block A:11
Zero:	blue	
Earth:	yellow/green	

Check the function by test running the pump in menu "Installer/Service/Function test" in the control system.

7.6 Heating circuit 2 (alt. Free cooling)

Primary flow sensor 2 (B2) NTC 22k is connected to terminal blocks G15-G16 on the sensor terminal block.

fit the primary flow sensor to the primary flow pipe, ideally after the circulation pump.

The sensing part is towards the end of the sensor (see sketch).

- Attach the sensor using the cable tie provided.
- Ensure that the sensor makes good contact with the pipe. Apply contact paste to the front part of the sensor between the sensor and the pipe if good contact is otherwise difficult to obtain.
- **Important!** Insulate the sensor using pipe insulation.
- Connect the cables to the sensor terminal block at position G15–G16.

Mixing valve 2 (Y2) is connected to terminals blocks A15, A16 and zero on the sensor terminal block:

Black	Open	Terminal block A15
Brown	Close	Terminal block A16
Blue	Zero	N

Radiator pump 2 (G2) is connected to terminals block A36 as well as zero and earth on the sensor terminal block:

Brown		Terminal block A36
Blue	Zero	N
Yellow/green	Earth	PE

Free cooling is adjusted using primary flow sensor 2 (B2), which then means that heating circuit 2 and cooling cannot be used simultaneously

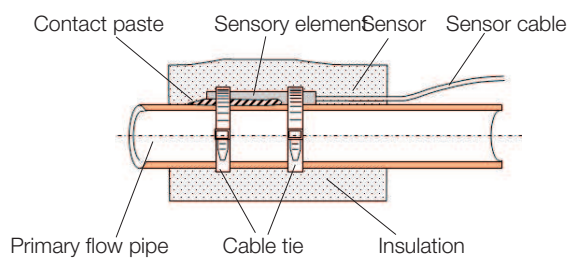

7.7 Pool (accessory)

Connect the sensor (B50) which measures the pool temperature to expansion card (A3) terminal block X3: 15-16.

Connect the circulation pump (G51) to expansion card (A3) as below:

Phase:	brown	Terminal block X: 33
Earth:	yellow/green	Terminal block X: 34
Zero:	blue	Terminal block X: 35

Connecting the diverting valve (Y50):

Control voltage	Black	Terminal block X6:24
Phase	Brown	Terminal block X6:25
Zero	Blue	Terminal block X6:26

Check the function by test running the pump in menu "Installer/Service/Function test".

7.8 External heat source (EHS)

The sensor (B47) from the external heat source is connected to the relay card (A2) at terminal block G67-68.

Connection for controlling the mixing valve (Y41) is done as follows:

Black cable	Open	Terminal block A27
Brown cable	Close	Terminal block A28
Blue cable	Zero	Terminal block A29

7.9 CTC EcoVent (accessory)

To connect the CTC EcoVent ventilation product, please refer to the CTC EcoVent manual.

7.10 CTC SmartControl (accessory)

To connect CTC SmartControl, please refer to the separate CTC SmartControl manual.

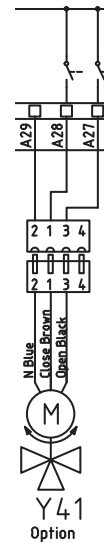

7.11 Solar heat (accessory)

Pump solar panel (G30) PWM

230 V 1N~

Circulation pump G30 is powered separately (not from this unit). The PWM control signal is connected to the following terminal blocks:

Expansion card (A3) X5:

Note cable colours!

PWM+:	white	Terminal block X5: 1
GND:	brown	Terminal block X5: 2

Check the function by test running the pump in menu "Installer/Service/Function test" in the control system.

Pump intermediate heat exchanger solar panels (G32) PWM

230 V 1N~

Pump G32 is powered separately (not from this unit). The PWM control signal is connected to the following terminal blocks:

Expansion card (A3) X5:

Note cable colours!

PWM+:	blue	Terminal block X5:3
GND:	brown	Terminal block X5:4

Check the function by test running the pump in menu "Installer/Service/Function test" in the control system.

Pump bedrock (G31) on/off

230 V 1N~

Circulation pump G31 is connected at the following terminal blocks:

Expansion card (A3) X6:

Note the cable colours!

Phase:	brown	Terminal block X6:8
Zero:	blue	Terminal block X6:11
Earth:	yellow/green	Terminal block X6:10

Check the function by test running the pump in menu "Installer/Service/Function test" in the control system.

Valve 2 tanks (Y30)

230 V 1N~

Diverting valve Y30 is connected at the following terminal blocks:

Expansion card (A3) X6:

Control voltage:	black	Terminal block X6:4
Phase:	brown	Terminal block X6:5
Zero:	blue	Terminal block X6:7

Valve bedrock (Y31)

230 V 1N~

Diverting valve Y31 is connected with pump G31 at the following terminal blocks:

Expansion card (A3) X6:

Control voltage:	black	Terminal block X6:8
Phase:	brown	Terminal block X6:9
Zero:	blue	Terminal block X6:11

7.12 Current sensor connection (accessory)

The current sensors are connected at G37–G40 on the sensor terminal block.

The three current sensors, one for each phase, are fitted on the fuse panel. Each phase from the electricity distribution board supplying the product is channelled through a current sensor before termination at the relevant terminal. This allows the phase current to be sensed all the time and compared with the value set for the heat pump's load switch. If the current is higher, the control unit drops to a lower heat output on the immersion heater. If this is insufficient, the heat pump is also limited. When the power drops back below the set value, the heat pump and immersion heater are reconnected. This means that the current sensors, along with the electronics, prevent more power being supplied than the main fuses can tolerate.

The current sensors' cable holes are 11 mm in diameter.

The current sensor connection has no alarm, but the current value can be read in the Operation data menu. Note that the tolerance/accuracy is very low with small current values.

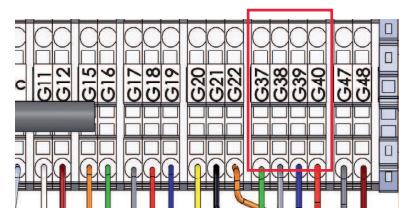

Connect to G37–G40 on the sensor terminal block. Use at least a 0.5 mm² cable.

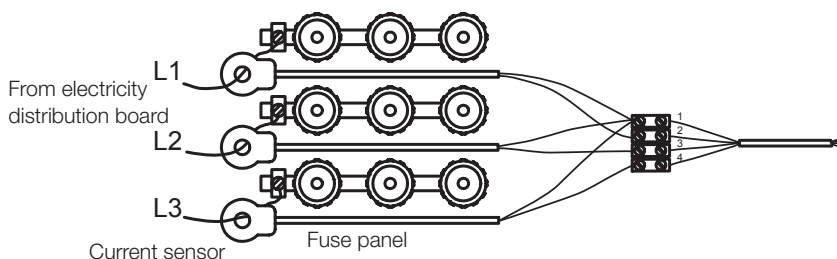

7.13 Tank schematic diagram (A2)

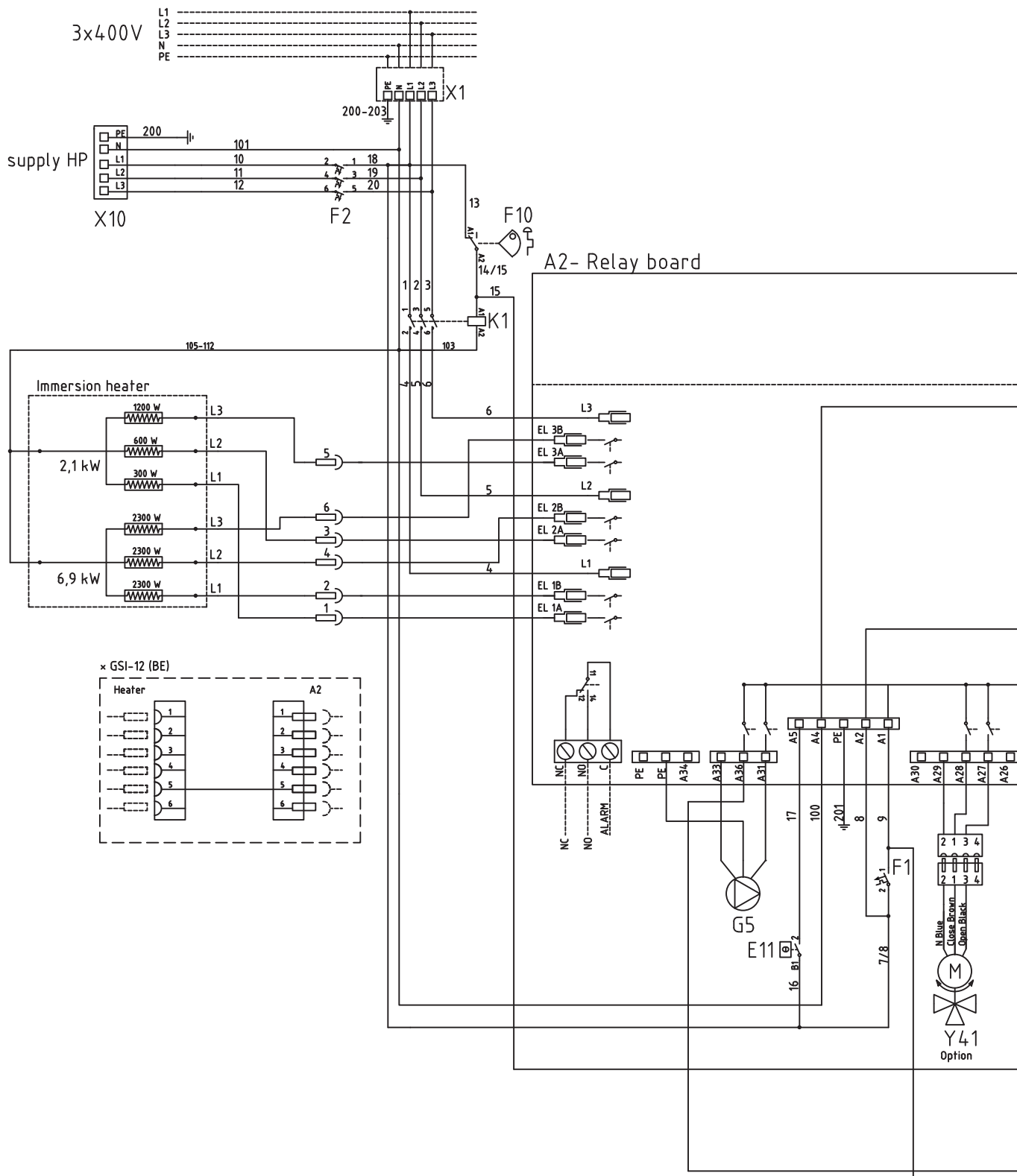

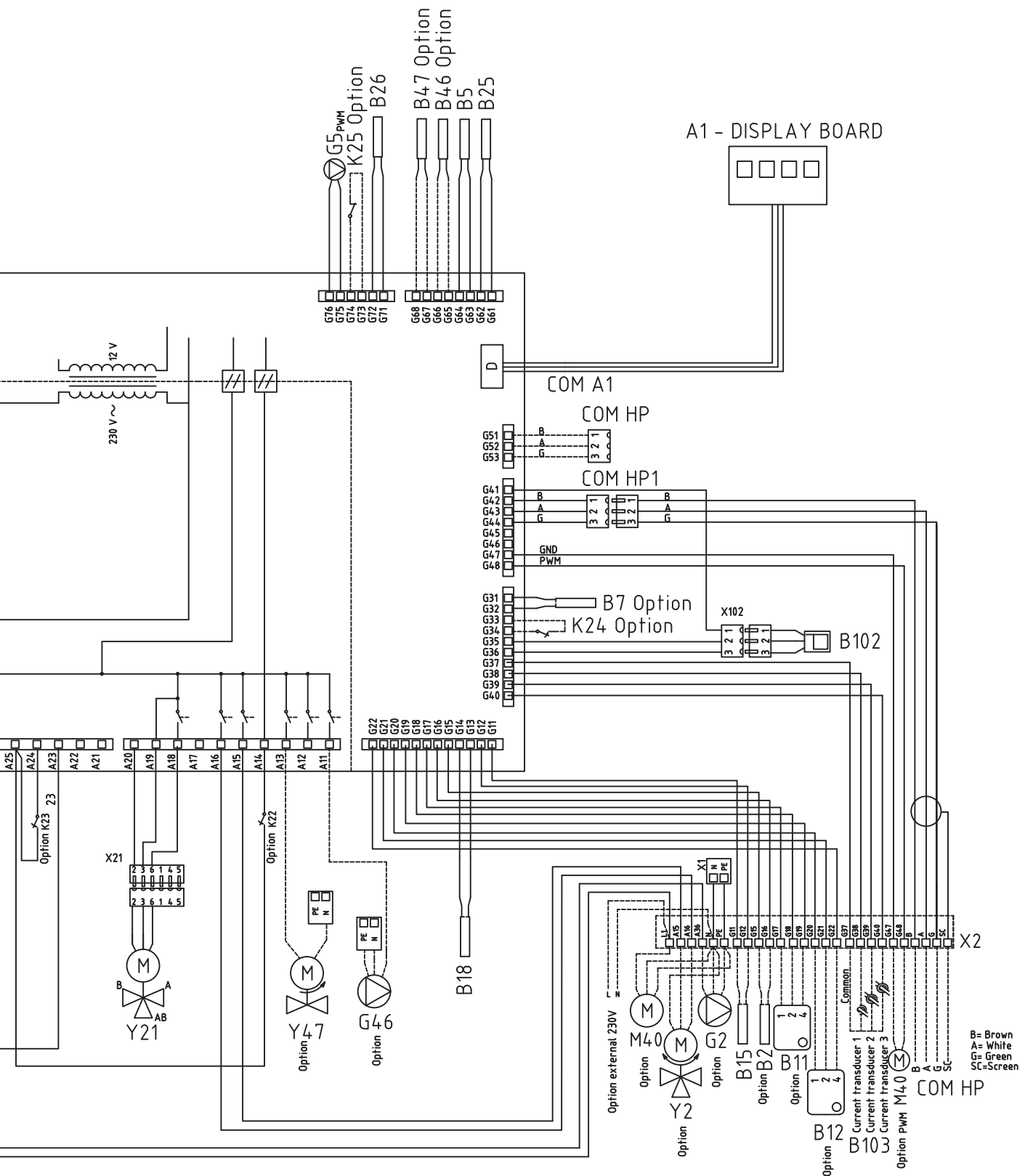

7.14 HP cooling module schematic diagram (A5)

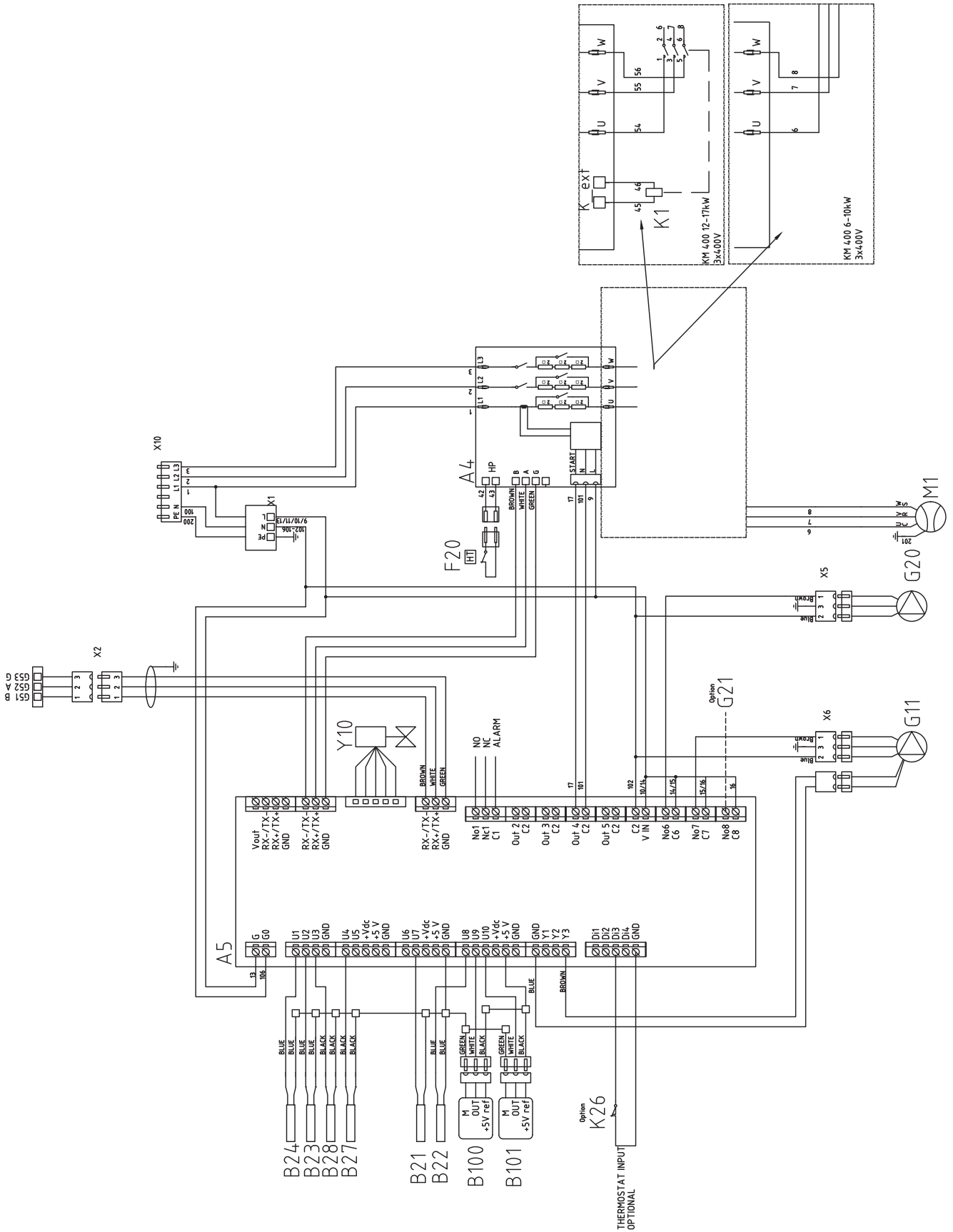

7.15 Expansion card (accessory) schematic diagram (A3)

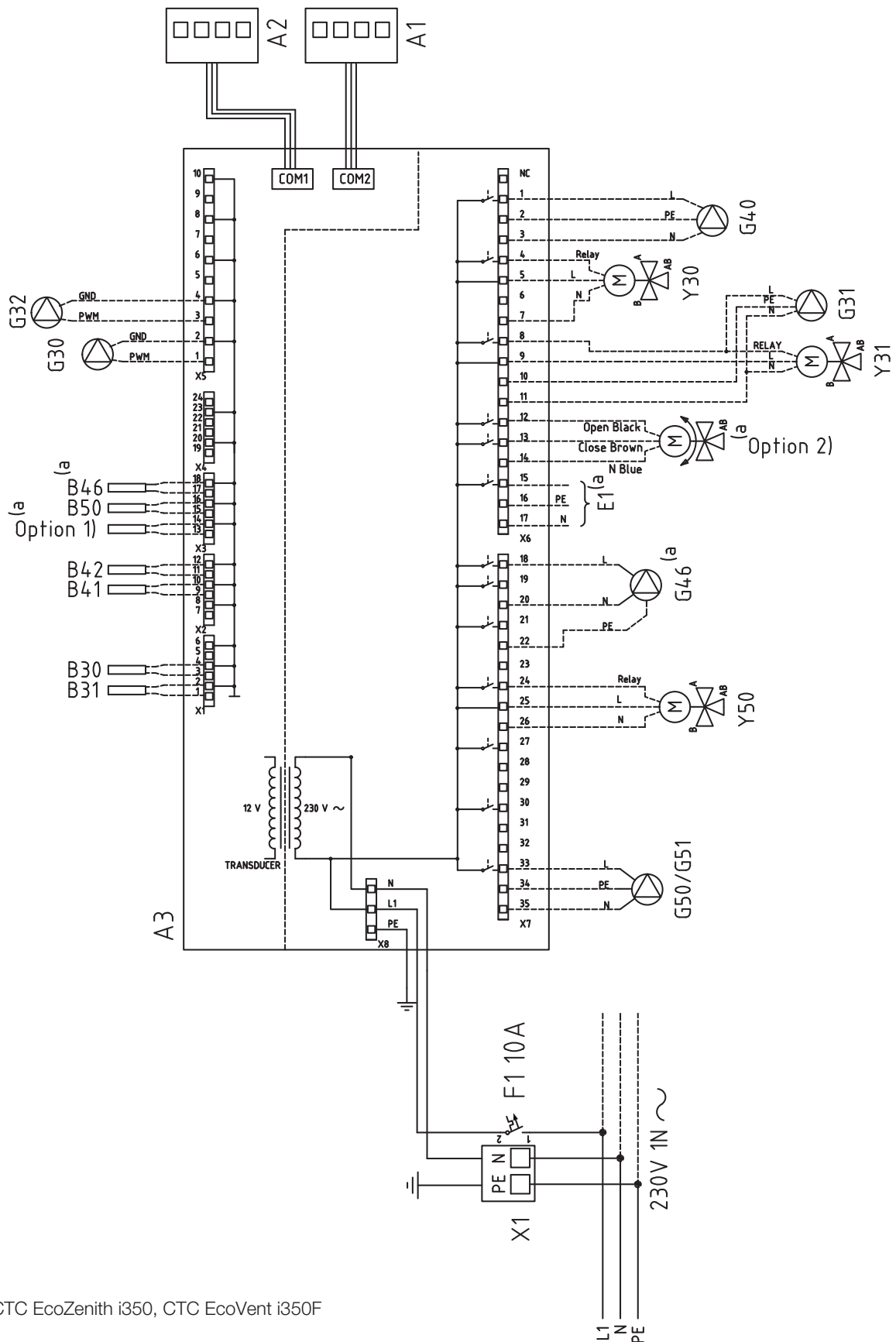

a) CTC EcoZenith i350, CTC EcoVent i350F

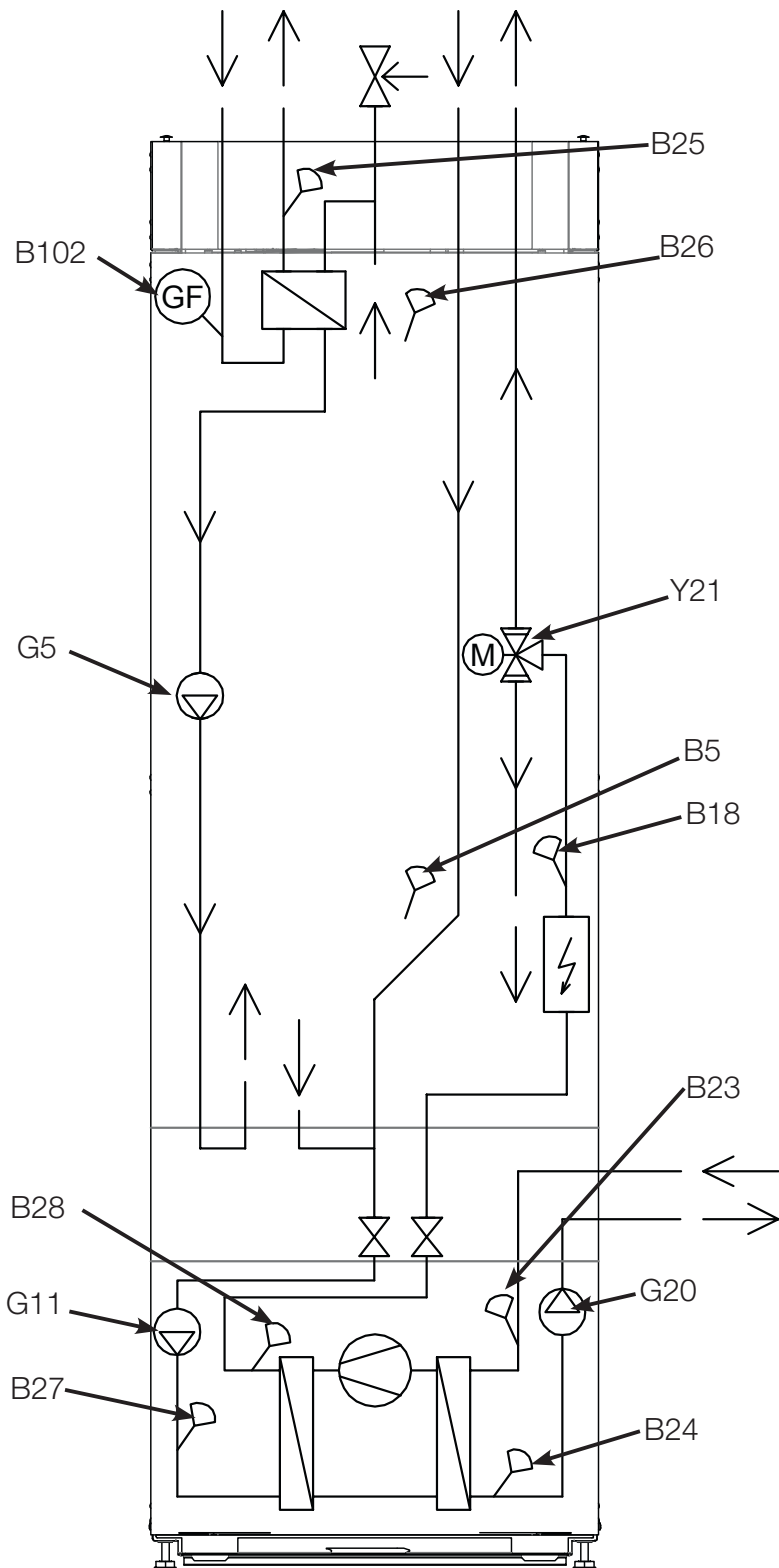

7.16 Parts list

A1	Display	
A2	Relay/main card	
A3	Expansion card	
A6	Gateway, SmartControl	
A5	HP control card	
A10	Driver	
B2	Primary flow sensor 2	NTC 22
B5	Sensor, DHW tank	NTC 22
B7	Return sensor	NTC 22
B11	Room sensor 1	NTC 22
B12	Room sensor 2	NTC 22
B15	Outdoor sensor	Type 1/ NTC 150
B18	Primary flow sensor	NTC 22
B21	Temperature sensor Discharge	Type 3/ NTC 50
B22	Temperature sensor Suction gas	Type 1/ NTC 015
B23	Brine in	Type 1/ NTC 22
B24	Brine out	Type 1/ NTC 22
B25	DHW sensor	NTC 015
B26	Sensor, upper hot water tank	NTC 22
B27	HP in	Type 2/ NTC 22
B28	HP out	Type 2/ NTC 22
B30	Solar panel sensor In	PT 1000
B31	Solar panel sensor Out	PT 1000
B41	Sensor, external buffer tank upper	NTC 22
B42	Sensor, external buffer tank lower	NTC 22
B46	Sensor diff thermostat	NTC 22
B47	External heat source tank	NTC 22
B50	Sensor pool	NTC 22
B100	High pressure sensor	
B101	Low pressure sensor	
B102	Flow switch	
F1	Automatic circuit breaker	10 A
F2	Automatic circuit breaker	13 A
F10	Max thermostat	
F20	High pressure switch	
G2	Circulation pump 2	
G5	Circulation pump for DHW heat exchanger	
G11	Charge pump HP1	
G20	Brine pump	
G30	Circulation pump, solar panel	
G31	Pump, bore hole recharging	
G32	Pump, plate heat exchanger – solar energy	
G40	Circulation pump for hot water coil	
G46	Circulation pump, diff thermostat	
G50	Circulation pump, pool	
K1	Contactors 1	
K22- K25	Flexible remote control/Smartgrid	
K26	Thermostatic control, accessory (Basic Display)	
M1	Compressor	
M40	Fan	
X1	Terminal board	
X10	Extra terminal board	
Y2	Mixing valve 2	
Y10	Expansion valve	
Y21	Diverting valve DHW 1	
Y30	Solar 2-step valve external buffer tank	
Y31	Solar 2-step valve	
Y41	External heat source tank	
Y47	Electric shut-off valve	
Y50	Diverting valve, pool	

Temperature °C	Sensor Type 1 NTC kΩ	Temperature °C	Sensor Type 2 NTC kΩ	Temperature °C	Sensor Type 3 NTC kΩ	Temperature °C	NTC 50 kΩ
100	0.22	100	0.67	130	5.37	150	0.89
95	0.25	95	0.78	125	6.18	145	1.00
90	0.28	90	0.908	120	7.13	140	1.14
85	0.32	85	1.06	115	8.26	135	1.29
80	0.37	80	1.25	110	9.59	130	1.47
75	0.42	75	1.47	105	11.17	125	1.67
70	0.49	70	1.74	100	13.06	120	1.91
65	0.57	65	2.07	95	15.33	115	2.19
60	0.7	60	2.5	90	18.1	110	2.5
55	0.8	55	3.0	85	21.4	105	2.9
50	0.9	50	3.6	80	25.4	100	3.4
45	1.1	45	4.4	75	30.3	95	3.9
40	1.3	40	5.3	70	36.3	90	4.6
35	1.5	35	6.5	65	43.6	85	5.4
30	1.8	30	8.1	60	52.8	80	6.3
25	2.2	25	10	55	64.1	75	7.4
20	2.6	20	12.5	50	78.3	70	8.8
15	3.2	15	15.8	45	96.1	65	10.4
10	4	10	20	40	119	60	12.5
5	5	5	26	35	147	55	15
0	6	0	33	30	184	50	18
-5	7	-5	43	25	232	45	22
-10	9	-10	56	20	293	40	27
-15	12	-15	74	15	373	35	33
-20	15	-20	99	10	479	30	40
-25	19	-25	134	5	619	25	50
-30	25	-30	183			20	62
						15	78
						10	99
						5	126

7.17 Resistances for sensors

Temperature °C	NTC 22 kΩ Resistance Ω
130	800
125	906
120	1027
115	1167
110	1330
105	1522
100	1746
95	2010
90	2320
85	2690
80	3130
75	3650
70	4280
65	5045
60	5960
55	7080
50	8450
45	10130
40	12200
35	14770
30	18000
25	22000
20	27100
15	33540
10	41800
5	52400
0	66200
-5	84750
-10	108000
-15	139000
-20	181000
-25	238000

Temperature °C	NTC 150 Outdoor sensor Resistance Ω
70	32
65	37
60	43
55	51
50	60
45	72
40	85
35	102
30	123
25	150
20	182
15	224
10	276
5	342
0	428
-5	538
-10	681
-15	868
-20	1115
-25	1443
-30	1883
-35	2478
-40	3289

Temperature °C	NTC 015 Resistance Ω
40	5830
35	6940
30	8310
25	10000
20	12090
15	14690
10	17960
5	22050
0	27280
-5	33900
-10	42470
-15	53410
-20	67770
-25	86430

8. First start

When the heat pump is delivered, the compressor is blocked to avoid it being unintentionally started. The heat pump can be installed and started before the brine circuit is put into operation.

The heat pump can also be started without a room sensor (accessory) being fitted as the set curve then regulates the heating. The sensor can, however, always be fitted for the alarm LED function.

Before first start

1. Check that the heating boiler and system are full of water and have been bled.
2. Ensure that the brine system is filled with water and antifreeze and that it is bled, or ensure that the compressor is blocked.
3. Check that all connections are tight.
4. Check that all sensors are connected to the electrical supply.
5. Check that the connections behind the insulation caps are secure. Remove both insulation caps by pulling carefully on the points marked.
6. The backup heating thermostat has OFF as its factory setting. Recommended mode is ❄ = Frost protection setting, approx. + 7 ° c. The backup heating thermostat is located in the electrical switchboard behind the front panel. It is in the OFF position when it is turned anticlockwise as far as it will go (the screwdriver slot should be vertical).

At the end of the installation, check the connections of any current sensors. In this situation it is important that you have switched off any major consumers of electricity in the house. Also make sure that the backup thermostat is turned off.

Note! The product has an automatic bleeding sequence for the DHW system, which runs in the background. The sequence takes approximately 15 minutes and does not affect other functions.

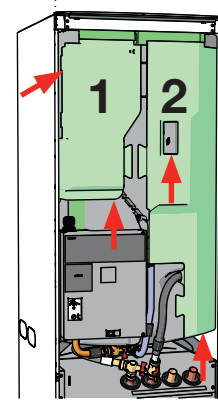

Check connections



Symbol for backup heating thermostat:

i The selected power output must be written on the rating plate with a marker.

i Save these settings under: Installer/ Settings/Save settings

First start

Switch on the power using the safety switch. The display will switch on. The heat pump now asks the following:

1. Select the language and push OK.
2. Confirm that the system is filled with water and press OK.
3. Size of main fuse Choose between 10 and 35 A.
4. Specify the maximum electric heater power. Choose between 0.0 and 9.0 kW in steps of 0.3 kW. See also "When only an electric boiler is operating" below.
5. Select the option permitting the compressor to operate (if the collector system is ready). When the compressor is started for the first time, a check is automatically carried out to ensure that it is running in the correct direction.
6. Brine pump on 10 days
7. Specify the max primary flow °C for heating circuit 1.
8. Specify the inclination for heating circuit 1.
9. Specify the adjustment for heating circuit 1.
If the primary flow sensor for heating circuit 2 is installed, repeat steps 7 to 9 for heating circuit 2.
10. The heat pump then starts and the start menu appears.

When only an electric boiler is operating.

When the product is started without boreholes, the electrical output must be specified for DHW production. Installer/Settings/Immersion heater/Max. immersion heater DHW kW

9. Operation and Maintenance

When the installer has installed your new heat pump, you should check along with the installer that the system is in perfect operating condition. Let the installer show you where the switches, controls and fuses are so that you know how the system works and how it should be maintained. Bleed the radiators after around three days of operation and top up with water if required.

Boiler and heating circuit bleeding/safety valve

Check around four times a year that the valve is working correctly by manually turning the control. Check that there is water and not air coming out of the waste pipe; if air is coming out then the tank will need to be bled.

Mixing valve (accessory)

Mixing valve (Y2) is operated automatically from the control system, ensuring that the radiators reach the correct temperature, no matter what season it is. However, where a fault occurs, you can operate the valve by pulling out the knob on the motor and turning it clockwise to reduce the temperature or anticlockwise to increase it.

Draining the tank

The heat pump should be disconnected from the power source when it is being drained. The drainage valve is positioned at the bottom left of the unit when viewed from the front, behind the front of the heat pump. When draining the whole system, the mixing valve should be fully open, i.e. turned anticlockwise as far as it will go. Air must be supplied to the closed system.

Operation stop

The heat pump is shut down using the operating switch. If there is a risk of the water freezing, all the water should be drained from the heat pump and the heating circuit. The DHW circuit, which contains around five litres, is emptied by inserting a hose at the bottom of the cold water connection and then siphoning it off.



■ Do not forget to reset the mixing valve (Y2) to automatic mode.



10. Menu overview

Start menu

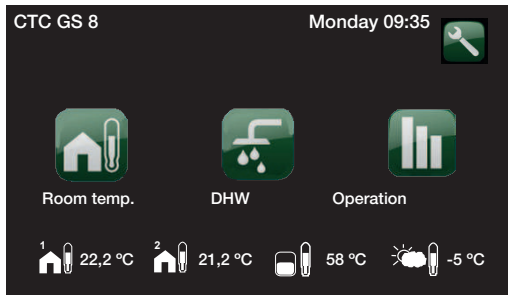

Room temperature settings

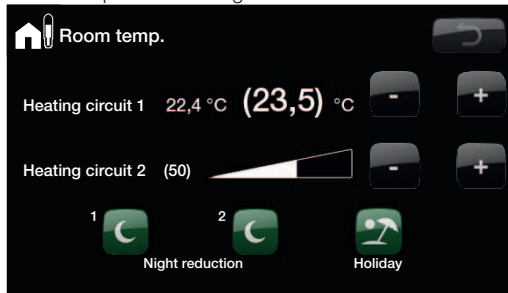

Selecting DHW comfort

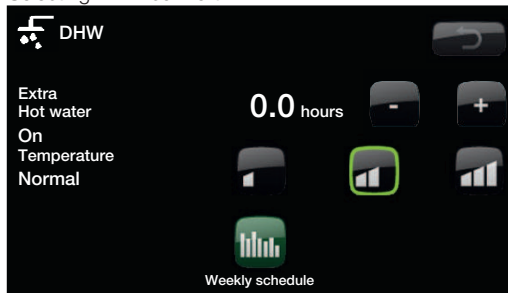

Heating system data

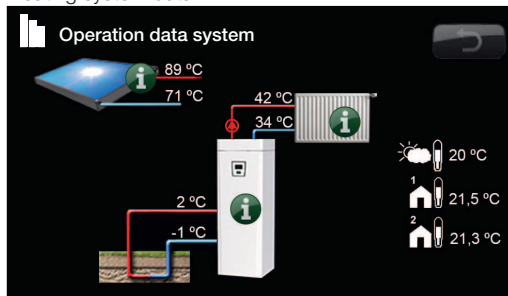

Installer settings menu

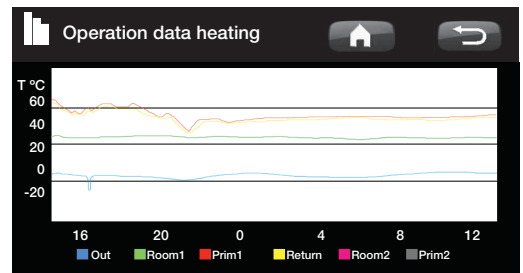
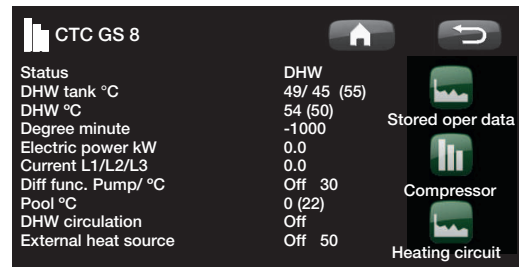
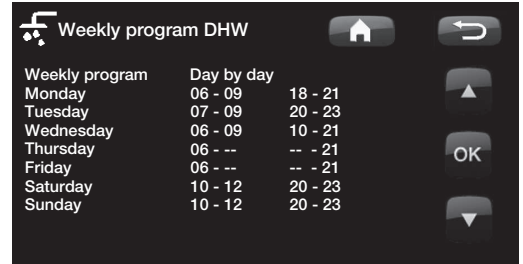
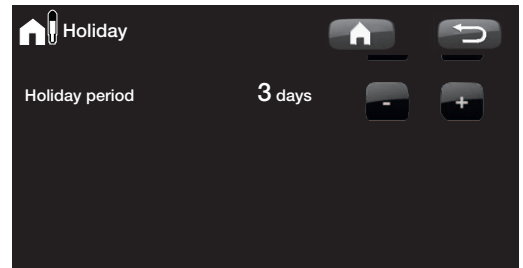
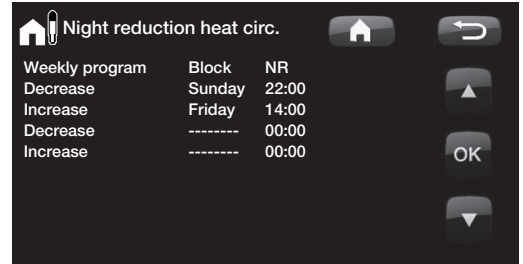
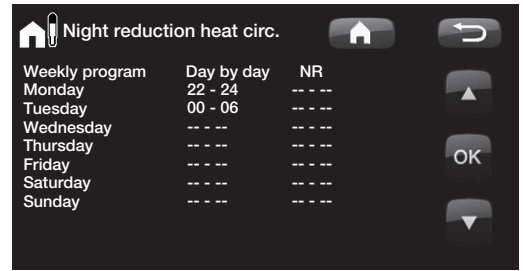
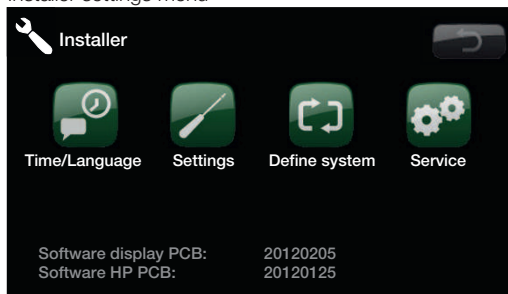

Stored oper data

Total operation time h:	14196
Max primary flow °C:	51
Electric Heating kWh	20

Compressor:

Total operation time	1540
----------------------	------

Compressor

Compressor	On
Charge pump	On 47%
Brine pump	On
HP in/out °C	35.5 / 42.3

Heating Circuit

Primary flow 1 °C	37 (38)
Return flow °C	33
Radiator pump	On

Primary flow 2°C	37 (38)
Radiator pump 2	On
Mixing valve 2	Off

Installer

Time Language

Settings

- Heating circuit 1
- Heating circuit 2
- Heat pump
- Electric heater
- DHW-tank
- Communication
- Cooling
- Solar panels
- Diff thermostat function
- Pool
- External heat source
- EcoVent
- Save settings
- Load settings
- Load factory settings

Define system

- Heating circuit 1
- Heating circuit 2
- Heatpump
- CTC SMS
- Cooling
- Solar panels
- Diff thermostat function
- Pool
- DHW circulation
- External heat source
- Input voltage
- Remote control

No No No No 3x400V

Service

- Function test
- Alarm log
- Factory settings coded
- Quick start compressor.
- Software update, USB
- Write log to USB
- Control current sensors
- Re-installation

11. Detailed menu descriptions

All settings can be configured directly on-screen using the easy-to-read control panel. The large icons function as buttons on the touch display.

Operational and temperature information is also displayed here.

11.1 Start menu

This menu is the system's home screen. An overview of the current operational data is provided here.

Once an EcoVent ventilation product is connected and defined, the appearance of the home screen will change and a number of submenus will become accessible. Display menus specific to the EcoVent product are described in detail in the EcoVent Installation and Care instructions.





 **Room temperature**
Settings for raising or lowering the temperature indoors and also for scheduling temperature changes.

 **DHW**
Settings for DHW production.

 **Operation**
This displays current operational data for both your heating circuit and your heat pump. Historical operational data is also available.

 **Installer**
This option is used by the installer to configure the settings and servicing for your heating circuit.

 **Room temperature heating circuit 1**
If heating circuit 1 is defined, the current room temperature is displayed here.

 **Room temperature Heating circuit 2**
If heating circuit 2 is defined, the current room temperature is displayed here.

 **Tank temperature**
This displays the current DHW temperature in the upper part of the tank.

 **Outdoor temperature**
This displays the current outdoor temperature.

 **Home**
The Home button takes you back to the Start menu.

 **Return**
The Return button takes you back to the previous level.

 **OK**
The OK button is used to mark and confirm text and options in the menus.

 **Night reduction**
This schedules night reduction if selected.

 **Holiday**
You can use this to reduce the room temperature permanently, e.g. during holidays when the house is unoccupied.

 **Weekly program**
This is used to reduce the temperature for a few days, for instance if you commute every week.

 **Stored oper data**
This displays historical data.

 **Time/Language**
This is used to set the date, time and the language you want the menu to be displayed in.

 **Settings**
The settings for operating the heat pump and system are usually configured by the installer.

 **Define system**
The heating circuit's structure can be adjusted/modified using this option.

 **Service**
Advanced settings are configured by the appropriate technical person.

11.2 Room temperature



The desired room temperature is set here. Use the plus and minus buttons to set the temperature you want. The “setpoint” temperature is given in brackets. You can see the current value next to the brackets.

If two heating circuits are installed, the values for both are displayed here.

If you want to schedule a temperature reduction, you can continue to the Night reduction or Holiday submenus.

Room sensor (accessory) is defined in the Installer/ Define system/Heating circuit menu. Select “Room sensor No” if the room sensor is poorly positioned, if the floor heating system has separate room sensors or if you use a fire place or open stove. The alarm LED on the room sensor still functions as normal.

If you use the fire or open stove only occasionally, the firing process can affect the room sensor and reduce the temperature supplied to the radiators. It can then get cold in the rooms in other parts of the house. The room sensor can temporarily be deselected during the firing process. The heat pump then provides heating to the radiators using the set heating curve. The radiator thermostats reduce the heating supplied to the section of the house where a fire is burning.



The example above shows that the room temperature is 22.4°C, but the desired value (setpoint) is 23.5°C.

The first figure is the preset factory value, while the values in brackets are the value's range.

11.2.1 Setting without a room sensor

If no room sensor (accessory) is installed (selected in the Settings menu), you adjust the room temperature using this option, which displays the setting range as a percentage. If this range is not sufficient, the default setting must be adjusted under the Installer/Settings/Heating circuit menu.

Change the value in small steps each time (approx. 2 to 3 steps) and wait for the result (approx. one day), as there is a delay in the system responding.

Several adjustments may be necessary at different outdoor temperatures, but you will gradually achieve the right setting that will not need to be changed.

11.2.2 Outdoor sensor/room sensor errors

If a fault occurs with an outdoor sensor, an outdoor temperature of -5°C is simulated so that the house does not get cold. The product's alarm is triggered.

If a fault occurs with a room sensor, the heat pump automatically switches to operating according to the set curve. The product's alarm is triggered.

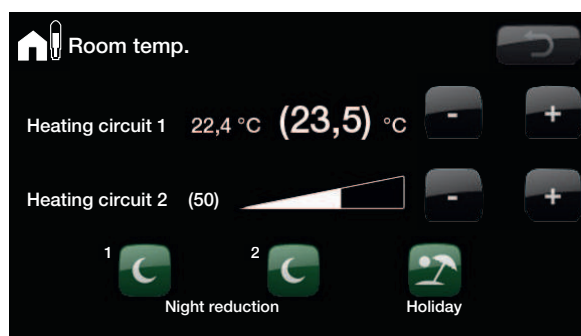

The example above shows operating with two heating circuits. Heating circuit 1 with a room sensor and heating circuit 2 without one.

! The radiator thermostats must always be fully open and operating correctly when the system is tuned.

11.2.3 Night reduction in temperature



You use this menu to activate and set a reduction in the temperature at night. A night reduction means that you reduce the temperature indoors during scheduled periods, for example, at night or when you are working.

The value by which the temperature is reduced, *Room temp reduced °C*, is set under Installer/Settings/Heating circuit/Factory setting: -2°C.

The options are *Off*, *Day by Day* or *Block*. If you select "Off", no reduction is made at all.

Day by day menu

You use this menu to schedule a reduction on the days of the week. This schedule is repeated every week.

The time set is when you want to have night reduction; the temperature is normal at other times.

Block

This menu allows you to set a reduction for a number of days during the week, for example, if you work elsewhere on weekdays and are at home at weekends.

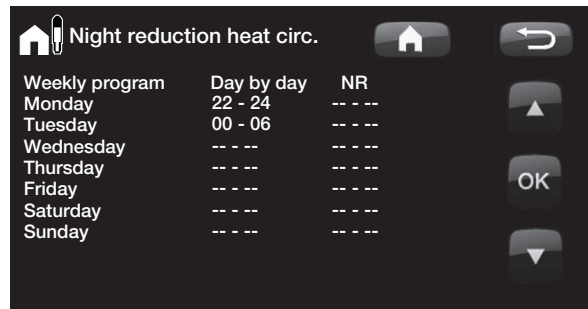

Example: On Monday evening at 10 pm the temperature is reduced to the set night reduction temperature. On Tuesday morning at 6 am it is raised to normal temperature.

Reducing a heat pump's temperature at night is a comfort setting which generally does not reduce energy consumption.

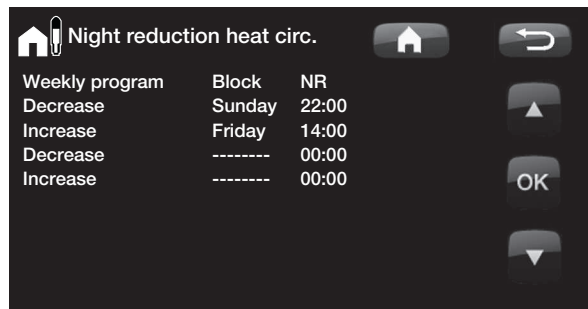

On Sunday at 10 pm, the temperature is reduced by the value set for Room temp. On Friday at 14:00 the temperature is increased to the set value again.

11.2.4 Holiday



You use this option to set the number of days that you want continuous reduction of inside temperature. For example, if you want to go on holiday. This function also ensures that hot water production shuts down.

Up to 300 days can be set.

The period starts from the time at which you set this parameter

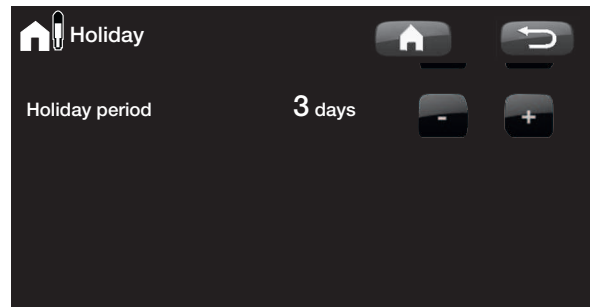

The value by which the temperature is reduced – Room temp reduced °C – can be set in the Installer/Settings/Heating circuit menu. Factory setting: -2 °C.

11.3 DHW



You use this to set the DHW comfort level you want and extra DHW.

Temperature

You set the values for this option which apply to the heat pump's normal operation. There are three modes:



Economic – Small DHW requirement.



Normal – Normal DHW requirement.



Comfort - Large DHW requirement.

The temperature can also be changed in the menu Installer/Settings/DHW tank. If this is done, the green frame around the icon for this menu disappears.

Extra DHW (On/Off)

You select this option if you want to activate the Temporary extra DHW function. When this function is activated, the heat pump starts producing extra DHW immediately. You also have the option to schedule DHW production for certain times using the Weekly program function, which is recommended.

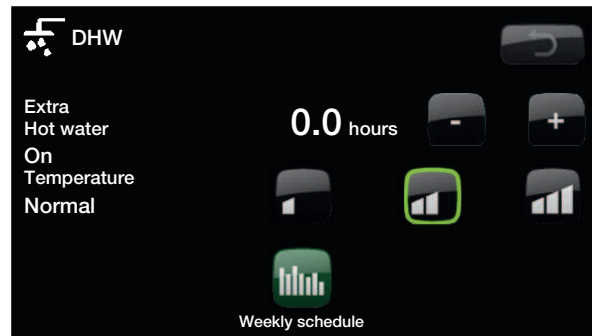

i Tip: Start by setting to Economic and if you find that you are not getting enough hot water, increase it to Normal, and so on.

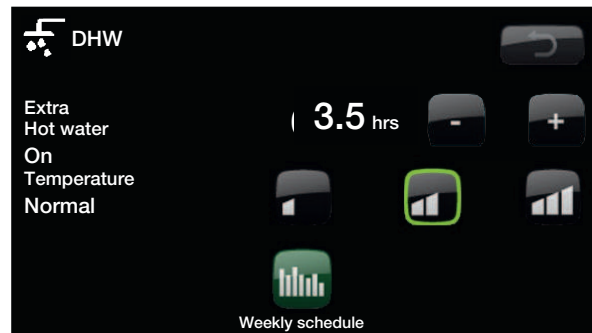

The example above shows that "Extra DHW" is set to On for 3.5 hours.

11.3.1 Weekly program DHW



You can use this menu to schedule periods during weekdays when you want extra hot water. This schedule is repeated every week. The image shows the factory settings, which can be changed. If you want an additional period on any day, e.g. in the evening, you can program recurring times.

The options are *Off* or *Day by Day*.

Off – No scheduled DHW production.

Day by Day – A weekly schedule which you program yourself. This is used if you always know when you regularly need extra hot water, such as in the morning and in the evening.

Weekly program	Day by day	
Monday	06 - 09	18 - 21
Tuesday	07 - 09	20 - 23
Wednesday	06 - 09	10 - 21
Thursday	06 - --	-- - 21
Friday	06 - --	-- - 21
Saturday	10 - 12	20 - 23
Sunday	10 - 12	20 - 23

On Monday morning at 06:00 the system starts producing more DHW until 09:00 when the temperature returns to normal again. There is a further increase between 18:00 and 21:00.

Tip: Set the time to approx. 1 hour before you need the hot water, as it takes a while to heat up the water.

11.4 Operation



This menu displays current temperatures and the operational data for your heating circuit.

The screen shows the incoming and outgoing temperatures from the heat pump.

Brine in

At the top left of the heat pump (2°C) the brine's current temperature is shown from the collector to the heat pump.

Brine return

The bottom left value (-1 °C) indicates the return temperature of the brine going back into the collector hose. The values vary during the year depending on the heat source's capacity and the energy consumed.

Primary flow to radiators

The primary flow temperature to the property's radiators is displayed to the right of the heat pump (42 °C). This value will vary during the year according to the parameters set and the current outdoor temperature.

Return radiators

At the bottom right (34 °C) the return temperature is shown for the radiator water when the heating circuit is being charged, no value is shown otherwise. This value will vary during operation according to the parameters set, the heating circuit's capacity and the current outdoor temperature.

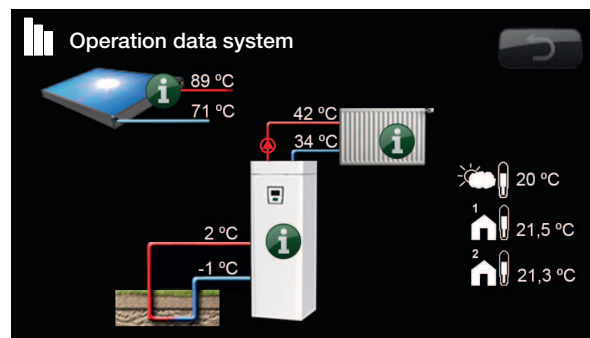

Information

Press the information button to display the operational data for the relevant item.



Current outdoor temperature

Shows the current outdoor temperature. The product uses this value to calculate the various operational parameters.



Current indoor temperature

Shows the current room temperature (if a room sensor is selected during operation). If two heating circuits are installed, the values for both are displayed.

11.4.1 Operational data CTC GS 6-8



This menu displays current temperatures and operating data. The first figure is the actual operational value, with the value in brackets being the setpoint which the heat pump is trying to achieve.

Status

Shows operating status. The various operating statuses are:

-> DHW

DHW is produced.

-> HC

Heat is produced for the heating circuit (HC).

-> Pool

Heat is produced for the pool.

-> Off

No heating takes place.

DHW tank °C 49/ 45 (55)

Displays hot water temperatures in the tank: upper part and lower part. The value in brackets is the setpoint (stop temp). The setpoint is measured in the upper part of the tank.

DHW °C 54 (50) 72%

Display of current temperature, current set point and current energy amount. If no hot water is drawn then no temperature is shown, just the setpoint.

Degree minute -1000

Shows current heat loss in degree minutes.

Electric power kW

Shows the output from the immersion heater (0 to 9.0 kW).

Current L1/L2/L3

Shows the system's total current consumption at the various phases L1/L2/L3, provided that three current sensors (accessories) have been fitted to the unit's incoming cables. If the current sensors are not identified, only the phase with the highest load is displayed. If the current exceeds the main fuse size, the boiler automatically switches down a power step to protect the fuses, for example, when several high-consumption appliances are being used in the house.

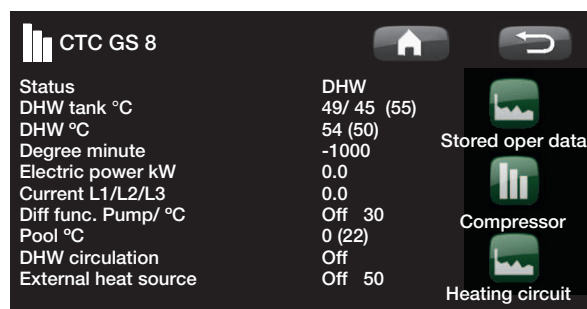

Degree minutes refers to the product of the cumulative heat loss in degrees (°C) and the time measured for this (in minutes).

Diff func. Pump / °C **Off/On/30**

Differential thermostat function. Shows whether the charge pump from the external tank is turned on. Also displays the temperature in the external tank.

Pool °C **19 (22)**

Displays pool temperature and setpoint (in brackets).

DHW circulation **Off/On**

Shows whether the DHW circulation pump is turned on.

External heat source **Active/Off /55**

Shows whether the external heat source is supplying heat. Also displays the temperature in the external tank.

11.4.2 Stored oper. data



This menu shows the operational values for the heat pump over a long period.

Total operation time h

Shows the total time during which the product has been on.

Max primary flow °C

Shows the highest temperature supplied to the radiators. The value may indicate the temperature requirements of the heating circuit/house.

EI. heat kWh

Shows the total energy consumed by the product's electric heaters. This is an indirect energy measurement, based on the operating periods of the electric heaters.

Total operation time

Displays the total operating time of the compressor.

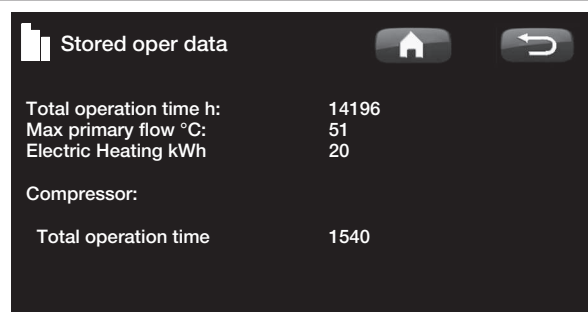

11.4.3 Compressor



This menu is intended for servicing and advanced troubleshooting.

Compressor (On/Off)

Shows whether the compressor is operating or not.

Charge pump (On/Off /47%)

Shows the operating status and flow of the charge pump (G11) as a percentage.

Brine pump (On/Off)

Shows whether the brine pump (G20) is operating or not.

HP in/out °C

Shows the heat pump's return and primary flow temperatures.

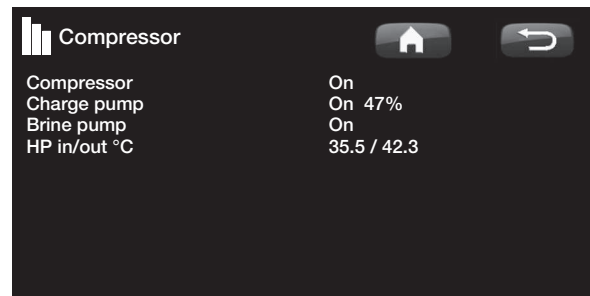

11.4.4 Operational Info Heating



system

Primary flow °C

Shows the temperature supplied to the system's radiators, along with the temperature which the system is trying to achieve. This value will vary during the year according to the parameters set and the current outdoor temperature.

Return flow °C

Shows the temperature of the water returning from the heating circuit to the heat pump.

Radiator pump

Shows the operating status of the radiator pump.

Accessories:

Primary flow 2 °C

Shows the temperature supplied to heating circuit 2, if it is installed.

Radiator pump 2

Shows the operating status of the radiator pump (G2).

Mixing valve 2

This indicates whether the mixing valve increases (opens) or reduces (closes) the heat supplied to heating circuit 2.

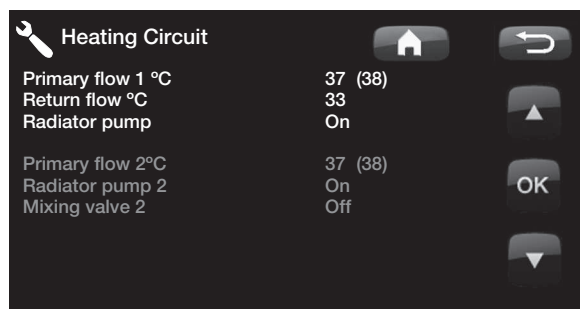

11.4.5 Stored oper. data



This displays the heating system's operation data for the last 24 hours. The furthest point to the right is the present, while the data for the last 24 hours is displayed to the left. The time "rolls" forward.

Blue curves show the current outdoor temperature.

The green and pink curves show room temperatures 1 and 2 respectively.

The red curve shows the primary flow temperature.

The grey curve shows the primary flow temperature of heating circuit 2 if it is installed.

The yellow curve shows the return temperature.

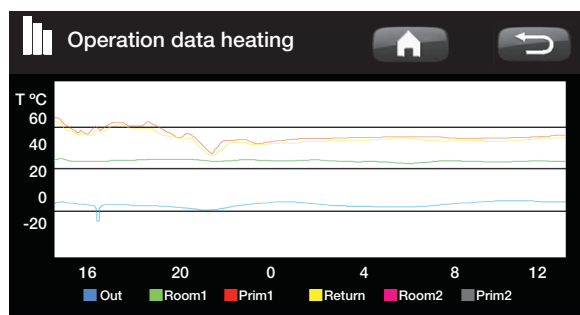

11.4.6 Operation data, solar panels

This menu displays current temperatures and operating data of solar collectors. The menu is only shown if solar collectors are defined.

Status

The operating status of the solar controls is shown here. The different operating modes that can be shown are: heating, not heating, charging EHS-tank, charging X-volume, charging bore hole, (charging bore hole), cooling panel, cooling tank, pre-cooling tank, sensor test and frost protect panel.

Solar panel In/Out °C

Shows the solar panel's incoming and outgoing temperatures.

EHS-tank (B47) °C

Shows the setpoint and current temperature in the external heat source tank.

EcoTank (B41)(B42) °C

Shows EcoTank's top temperature, the setpoint and the tank's bottom temperature.

X-volume (B41)(B42) °C

Shows the X-volume tank's top temperature, the setpoint and the tank's bottom temperature.

Pump solar panel (G30) %

The speed of the solar panel's charge pump is shown here (or Off).

Pump heatexchanger (G32) %

If the intermediate heat exchanger is used, the speed of the charge pump between the intermediate exchanger and tank is shown here (or Off).

Pump charging (G46)

Whether the charge pump is in operation during transfer is shown here.

Pump borehole charging (G31)

Whether the charge pump is in operation during bore hole charging is shown here.

Valve charging (Y31)

Shows whether charging is to tank or borehole.

Valve tank (Y30)

When two tanks are being charged by solar power, the position of the 3-way valve between the tanks is shown here.

Power output, kW

Shows the panel's output.

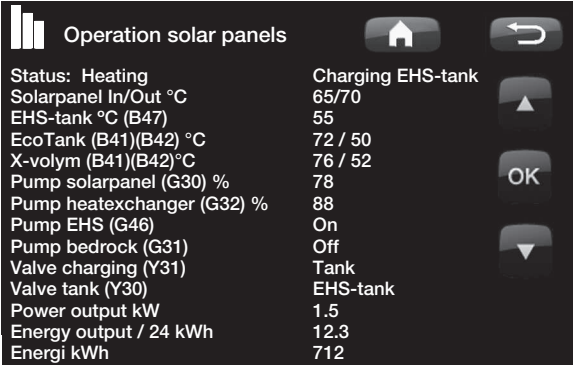

Operation solar panels	
Status: Heating	Charging EHS-tank
Solarpanel In/Out °C	65/70
EHS-tank °C (B47)	55
EcoTank (B41)(B42) °C	72 / 50
X-volym (B41)(B42) °C	76 / 52
Pump solarpanel (G30) %	78
Pump heatexchanger (G32) %	88
Pump EHS (G46)	On
Pump bedrock (G31)	Off
Valve charging (Y31)	Tank
Valve tank (Y30)	EHS-tank
Power output kW	1.5
Energy output / 24 kWh	12.3
Energi kWh	712

Energy output/24 h (kWh)

Shows the amount of energy absorbed in the last 24 hours. If heat is taken from the tanks (e.g. if a panel is being protected against frost), negative energy is calculated. During borehole recharging no useful energy is calculated. The value is updated at the end of the day (00:00).

Energy output kWh

Shows accumulated amount of energy absorbed in kWh.

Negative values are displayed if energy is taken from the tank, e.g. when sensors are being checked and panels are being protected against frost.

The panel output is displayed during bore hole recharging but the energy is not classed as accumulated.

Status:

Heating/Not heating

Status: Shows whether the solar collector is heating or not.

Charging EHS-tank/Charging EcoTank/Charging X-volume/Charging bore hole

Status: Shows whether EHS-tank, EcoTank, X-volume and/or bore hole is being charged.

Sensor test

Status: Displays "sensor test" when circulation pump is running, to check whether solar panel can heat up.

(Charging bore hole)

Status: Shows whether circulation pump is stopped to check whether panel can charge tank.

Cooling panel/Cooling tank/Pre-cooling tank/Frost protect panel

Status: Displayed when any protection function has been activated.

11.4.7 Operational data CTC EcoVent

Current operational data for the CTC EcoVent ventilation product is displayed here. The menu is only shown if EcoVent is defined.

For operational information, please refer to the CTC EcoVent manual.

11.5 Installer



This menu contains four sub-menus. Time/Language, Settings, Define system and Service.

Time/Language includes time and language settings for your CTC GS 6-8.

Settings are used both by the installer and user.

Define system is used by the installer.

Service is used for troubleshooting and diagnosis. You will find here the options Function test, Alarm history, Factory settings code, Quick start compressor and Software update.

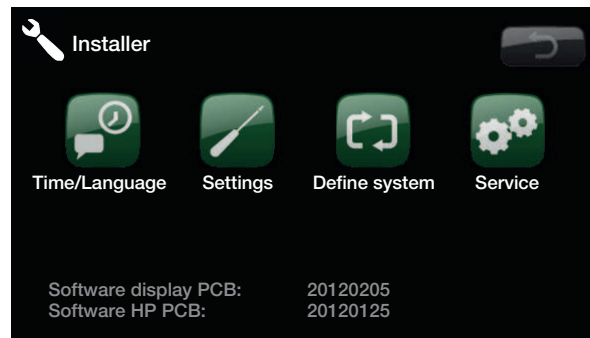

11.5.1 Time/Language

You use this to set the date and time. The clock saves the settings in the event of a power cut. Summer/winter time (daylight saving) is changed automatically.

Setting the time

Press *Time*. When a green box appears around the time, press OK and the first value is selected. Use the arrows to set the correct value.

When you press OK, the next value is highlighted.

Setting the language

Press *Language*. The current language has a green circle around it.

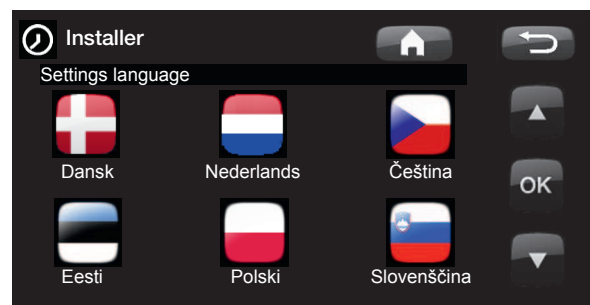
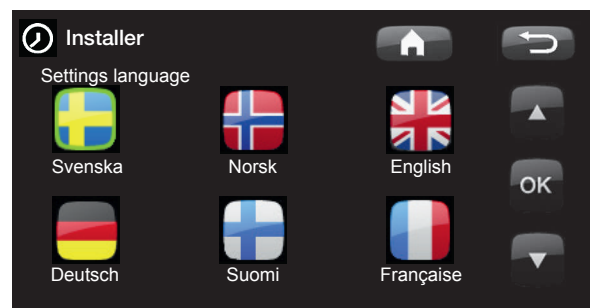
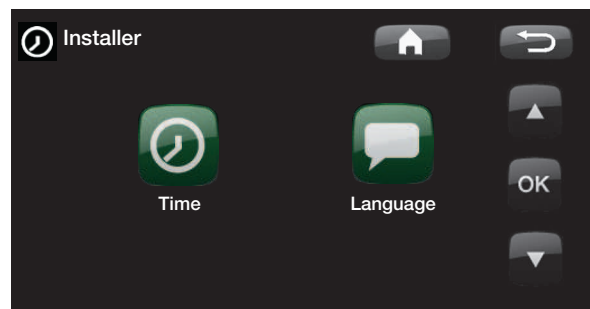

11.5.2 Settings



This menu is used to set the parameters for your home's heating requirements. It is important that this basic setting is right for your home. Values which are set incorrectly may mean that your property is not warm enough or that an unnecessarily large amount of energy is being used to heat your property.

Save settings

Here you can save your own settings.

Load settings

The saved settings can be reloaded using this option.

Load factory settings

The product is supplied with the factory values set. They can be restored by activating this function. The language, product and product size are retained.

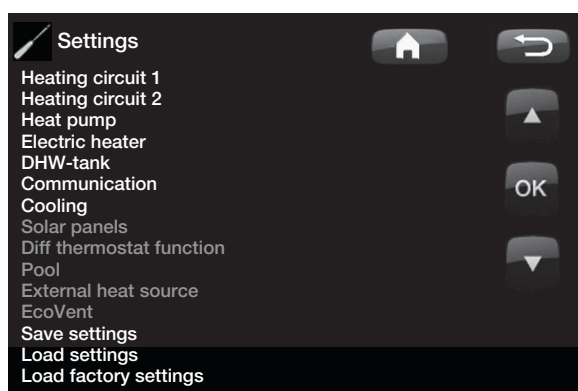

Heating circuit 1 (or 2)

Max primary flow **60 (30–80)**

The maximum permitted temperature to the radiators. This functions as an electronic limiter to protect the floor coils in underfloor heating systems. Heating circuit 2 can only give the same temperature as heating circuit 1 or a lower temperature.

Min primary flow **Off (Off, 15–65)**

You can use this option to set the minimum permitted temperature if you want a specific level of background heating during the summer in the basement or underfloor heating coils, e.g. in the bathroom. The heating in other parts of your property should then be switched off using thermostatic radiator valves or shut-off valves. Note that the radiator pump G2 will then operate for the whole summer. This means that the temperature supplied to the radiators will not fall below a selected temperature, for example +27°C. *Off* means that the function is turned off.

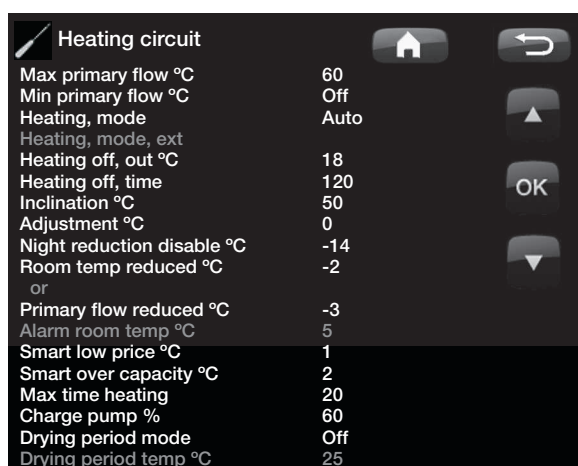

■ Tip: Read more about these settings in the section “Your home’s heating settings”.

■ There is no radiator pump in heating circuit 1. Instead, “Heating, mode” is controlled by the diverting valve.

Heating, mode **Auto/On/Off**

Switching between heating season and summer mode can take place automatically (*Auto*) or a selection can be made here to set the heating to *On* or *Off*.

Auto = switching between heating season (*On*) and summer mode (*Off*) takes place automatically.

On = Continuous heating season with constant radiator flow.

From (summer mode) = there is no warming. Radiator flow ceases.

In the menu described below (*Heating off, out* °C), the outdoor temperature is set, which then becomes the limit for switching between heating season and summer mode.

Heating mode, ext **--/Auto/On/Off**

Switching between heating and summer mode can be controlled remotely. Find out more in the section entitled "Define remote control".

Heating off, out **18 (10–30)**

Outdoor temperature limit at which the house no longer requires heating. The radiator pump stops. Radiator pump (G1/G2) is activated daily for a short period to reduce the risk of jamming. The system restarts automatically when heating is required.

Heat off, time **120 (30–240)**

Delay time before the radiator flow ceases once the outdoor temperature has reached the preset value according to the menu above.

Inclination (default setting) **50 (25–85)**

Inclination means the temperature your property needs at different outdoor temperatures. See more detailed information in the section "Your home's heating settings". The value set corresponds to the temperature of the radiators when the outdoor temperature is -15°C. After this default setting, fine adjustment takes place in the "Room temperature" menu.

Inclination adjustment **0 (-20–20)**

Inclination adjustment means that the overall temperature level can be raised or lowered at all outdoor temperatures. After this default setting, fine adjustment takes place in the "Room temperature" menu.

Night reduction of °C **5 (-40–40)**

When the outdoor temperature is lower than the preset value, the night reduction stops as too much energy is consumed and it takes a long time to increase the temperature. This menu overrides remote control.

For example:

Inclination 50 means that the temperature to the radiators will be 50°C when the outdoor temperature is -15°C if inclination adjustment is set to 0. If inclination adjustment is set to +5, the temperature will be 55 °C instead. For all outdoor temperatures the inclination is increased by 5 °C, i.e. inclination is parallel displaced by 5 °C.

Room temp reduced **-2 (0 – -40)**

“Room temp reduced” is displayed if a room sensor is installed.

This setting defines how many degrees the room temperature will be reduced by during the various scheduled reduction periods, e.g. Night reduction, Holiday, etc.

Primary flow reduced **-3 (0 – -40)**

If there is no room sensor installed, “Primary flow reduced” is displayed instead.

Alarm, low room temp °C **5 (-40 – 40)**

When the room temperature becomes lower than the preset value, “Alarm, low room temp °C” is displayed.

Smart Low price °C **1 (Off/1 – 5)**

Setting to increase inclination adjustment at energy price “Low price”, via Smartgrid. Read more in the “Smartgrid” section.

Smart over capacity °C **2 (Off/1 – 5)**

Setting to increase inclination adjustment at energy price “Over capacity”, via Smartgrid. Read more in the “Smartgrid” section.

Max. time Heating **20 (10 – 120)**

This is the maximum time (minutes) during which the heat pump charges the heating circuit if needed in the hot water tank.

Charge pump % **60 (25 – 100)**

Setting for charge pump (G11) speed (percent) when charging the heating circuit.

Drying period mode

Off(Off/1/2/3)

Floor drying function for newly-built properties.

The function limits the calculation of primary flow temperature (setpoint) for "Your home's heating settings" to the schedule below.

Mode 1

Floor drying function for 8 days.

#1. Heating circuit setpoint is set at 25 °C for 4 days.

#2. Days 5-8 use preset value *Drying period temp* °C.

From Day 9 onwards the value is calculated automatically according to "Your home's heating settings".

Mode 2

Drying period for 10 days + stepped increase and decrease.

#1. Stepped increase start. The setpoint for the heating circuit is set to 25 °C. The setpoint is then raised by 5 °C each day until it is equal to the *Drying period temp* °C.

The final step may be less than 5 °C.

#3. Stepped decrease. After the stepped increase and 10 days at an even temperature, the temperature setpoint is reduced to 25 °C in daily 5 °C stages.

The final step may be less than 5 °C.

Following the stepped decrease and one day at the setpoint of 25 °C, the value is calculated automatically according to "Your home's heating settings".

Mode 3

This mode starts with Mode 1, followed by Mode 2 and finally by "Your home's heating settings".

Drying period temp °C

25 (25–55)

Here you set the temperature for #2 as shown above.

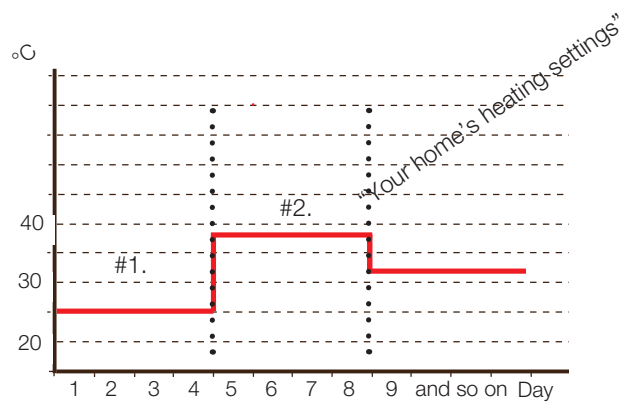

Example for Mode 1 with *Drying period temp* °C: 38 °C.

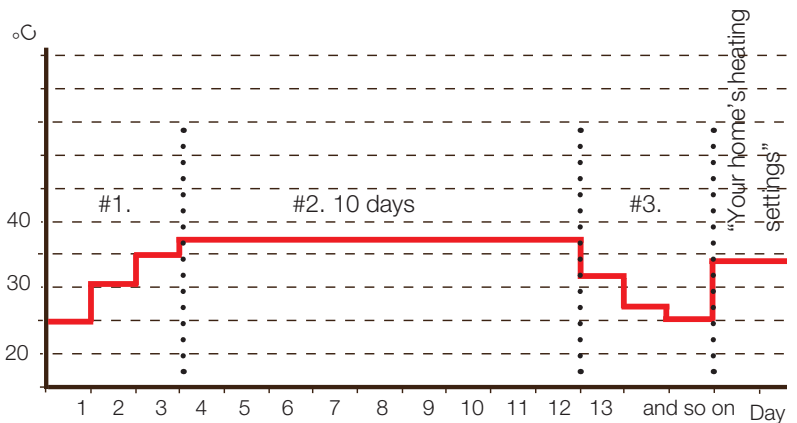

Example for Mode 2 with *Drying period temp* °C: 37 °C.

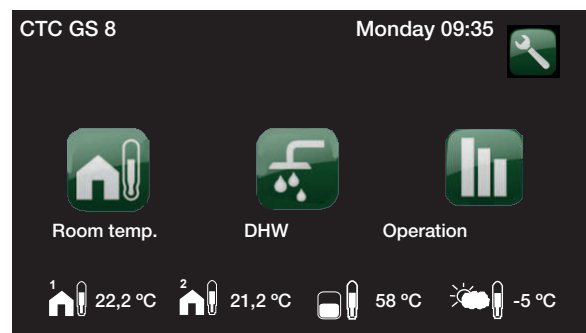

Example of operation data for Mode 2, Day 1 of 12 with current setpoint (25) °C.

11.6 Heat pump

Compressor **Permitted/Blocked**

The product is supplied with a blocked compressor. Since the compressor is blocked, the product operates like an electric boiler with full functionality. Permitted means that the compressor is allowed to operate.

Brine pump on **Auto/10d/On**

After installation, you can choose to run the brine pump as follows:

- *10d*: runs constantly for 10 days to remove air from the system, after which the pump returns to auto mode.
- *Till*: continuous brine pump operation.
- *Auto*: the brine pump (G20) runs simultaneously with the compressor.

Tariff HP **Off(On/Off)**

Find out more in the section titled “Define remote control”.

Smart blocking HP **Off(On/Off)**

Read more in the “Smartgrid” section.

Start at degree minute **-60 (-900--30)**

This states the degree minute at which the heat pump will start.

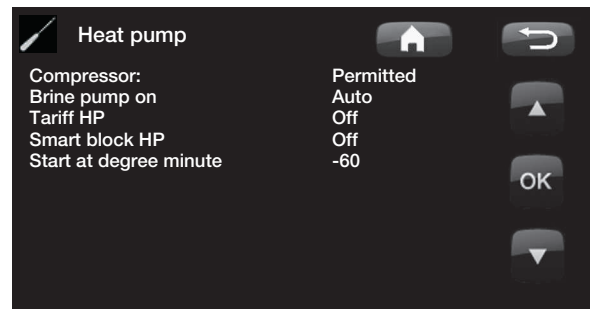

11.7 Electric heater

Max immersion heater kW 9.0 (0–9.0)

Maximum permitted output from electric immersion heater.

Max immersion heater DHW kW 0 (0–9.0)

Maximum permitted output from the immersion heater when charging hot water. Adjustable between 0 and 9.0 kW in steps of 0.3 kW.

Start at degree minute -500 (-900–-30)

This states at which degree minute the electric immersion heater will start.

Diff step, degree minute -50 (-20–-300)

This states the difference in degree minutes between the increments of output for the immersion heater. The output of the immersion heater is Max el. heater kW divided into 10 increments.

Main fuse A 20 (10–90)

The property's main fuse size is set here. This setting and the fitted current sensors ensure the fuses are protected when using appliances which generate temporary power peaks, for example, cookers, ovens, engine heaters, etc. The product temporarily reduces power drawn where this type of equipment is being used.

Conv. factor curr. sensors 1 (1–10)

–

Tariff EL Off (On/Off)

Find out more in the section titled "Define remote control".

Smart block immersion Off (Off/On)

Read more in the "Smartgrid" section.

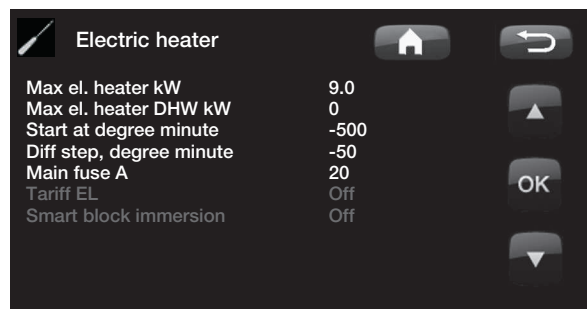

11.8 DHW tank

DHW program

Settings menu for *Economic*, *Normal* och *Comfort* programs. See chapter *DWH Program Settings*.

Start/stop diff. upper °C **5 (3–10)**

The temperature difference between charge start and stop.

Max time DHW **30 (10–150)**

This is the maximum time (in minutes) that the heat pump charges the hot water tank, if this is needed for the heating circuit.

Charge pump % **50 (25–100)**

Setting for charge pump (G11) speed during hot water charging. Only applies if the heat pump is not the sole heater.

Smart low price. °C **10 (1–30)**

Read more in the “Smartgrid” section.

Smart over capacity °C **10 (1–30)**

Read more in the “Smartgrid” section.

Min RPS DHW charging **50 (50–100)**

Not used for this product.

Start delay DHW min **3 (0-60)**

Start delay (minutes) for hot water charging after the flow of hot water has stopped.

DHW circulation (accessory)

The settings for hot water circulation require the installation of an expansion card accessory (A3).

Run-time DHW circ. **4 (1–90)**

Run-time (in minutes) of domestic hot water circulation during each period. Applies if *DHW circulation* has been defined in the *Installer/Define system* menu.

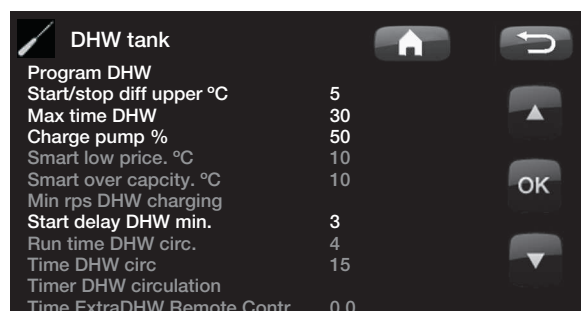

Time DHW circ. 15 (5–90)

The time during which domestic hot water circulation takes place. *DHW circulation* must have been defined in the *Installer/Define system* menu.

Timer DHW circulation Off/On/Day by Day

This menu displays the scheduled weekday periods when the DHW circulation pump is to run. This schedule is repeated every week.

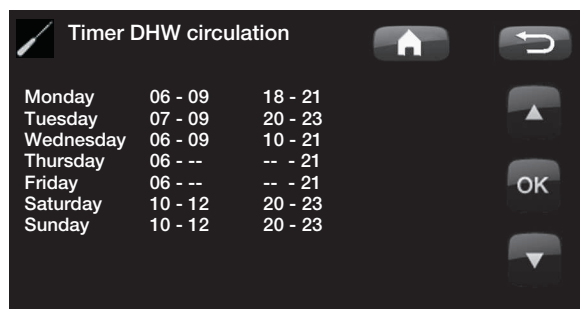

The time on the left must be lower than the time on the right for the interval to be valid.

Time Extra DHW Remote control 0.0 (0.0 – 10.0)

Time in full or half hour intervals during which the *Extra hot water* function is enabled when activated in the menu *Remote control (Installer/Define system/Remote control/Extra DHW)* or when activated by a CTC SmartControl accessory. For CTC SmartControl functionality and settings, please refer to the relevant manual.

11.8.1 DHW Program Settings

Options are *Economic*, *Normal* and *Comfort*.

Press *OK* to open the settings for the selected DHW program.

Charge start % No (No, 50 – 90)

Value *Charge start*: 60% means that hot water charging is allowed to start when the amount of hot water energy is at 60% or below.

No means that a low estimate of the amount of hot water energy does not affect the start of hot water charging.

Charge stop upper/lower °C 55 (20 – 65)

Hot water charging is complete once both sensors reach the set value.

Charge stop lower °C 40 (15 – 60)

Hot water charging starts when the temperature falls below the set temperature.

DHW °C 50 (38 – 65)

The temperature of outgoing hot tap water.

Reset program

The current DHW program will be restored to factory settings.

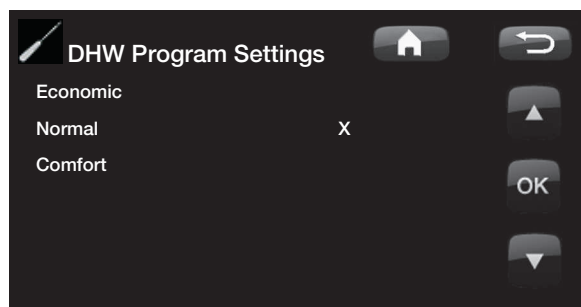

11.9 Communication

These settings are activated for the accessory's superior systems and are not used in normal operation. They are not described in these instructions.

11.10 Cooling

Cooling is adjusted using primary flow sensor 2 (B2), which means that heating circuit 2 and cooling cannot be used simultaneously.

Common Heating and Cooling **No (No/Yes)**

Yes means that free cooling and heat are distributed in the same channels.

Condense pipe secured **No (No/Yes)**

If a condense pipe for the system has been secured, significantly lower temperatures are permitted at various points in the system. **WARNING** Build-up of condensation in the house structure can lead to damp and damage from mildew.

(No) means a setting range for room temperature of 18–30°C and (Yes) means a setting range of 10–30°C

In the event of doubt, contact an expert surveyor for an assessment.

Room temp cooling **25.0 (10.0 or 18.0–30.0)**

This is used to set the desired room temperature for cooling.

Smart low price. °C **1 (Off, 1–5)**

Read more in the "Smartgrid" section.

Smart over capacity °C **1 (Off, 1–5)**

Read more in the "Smartgrid" section.

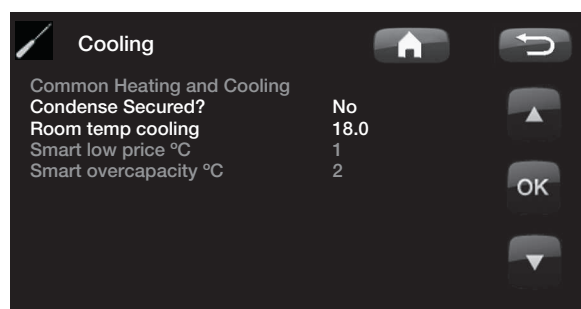
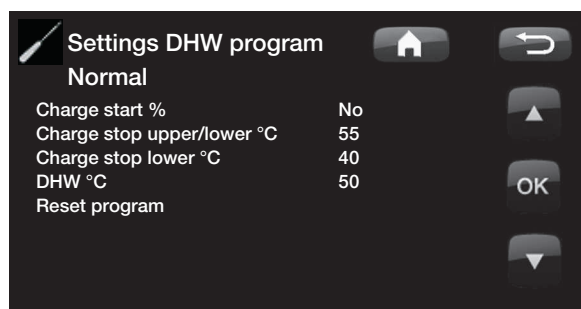

11.11 Solar panels (accessories)

The settings needed for the solar heating system to function optimally are entered here. It is important that this default setting is adjusted for your heating system. Incorrectly set values may lead to the intended energy saving being lower. The menu names that are shown in grey are not active and do not show in white until they are activated. Activation is carried out in the *Define system/Solar panels* menu.

11.11.1 Solar basic settings

Charge start diff temp °C **7 (3—30)**

Here you can set the temperature difference at which charging of solar energy should start. The solar panel must be this many degrees warmer than the tank temperature for charging to start.

Charge stop diff temp °C **3 (3—30)**

Here you can set the temperature difference at which charging of solar energy should stop. When the temperature difference between the solar panel and the tank falls below this set value, the charging stops.

Charge pump min % **20 (20—100)**

The lowest permitted speed of the charge pump (G30, G32) is indicated here.

Sensor test active **No (No/Yes)**

Whether or not the solar sensor should be activated is indicated here. If the solar panel sensor cannot be installed in such a way that the actual panel temperature can be detected, the charge pump needs to run for a while for the panel's fluid to have an effect on the sensor.

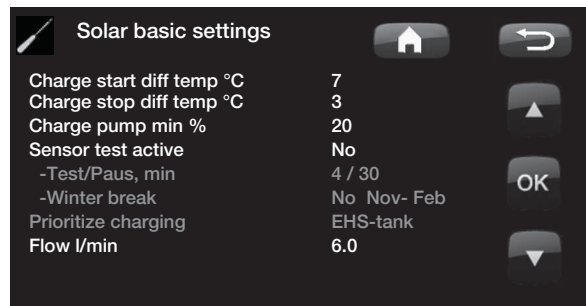
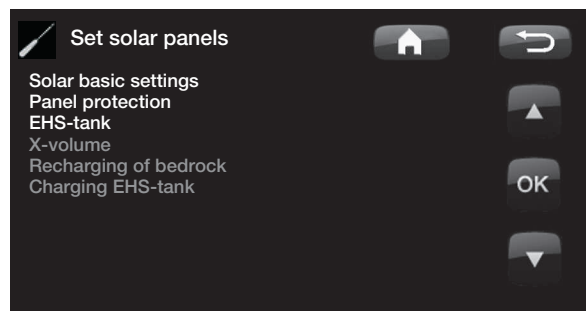

-Test/Pause, min **4 (1–20) /30(80–180)**

Test (4): This is where you indicate the duration of the sensor test so that awkwardly positioned sensors have enough time to detect the correct temperature. The length of the sensor test should be as short as possible to prevent heat being taken from the tank unnecessarily in situations when the solar panel cannot charge.

Pause (30): The time between the sensor tests is indicated here. A new sensor test will start after the pause.

-Winter break **No (No/Yes) Nov - Feb**

The months during which there will not be a sensor test are indicated here. During the winter, when the panel (as a rule) cannot heat the tank, there is no need to carry out sensor tests. A sensor test carried out at that time of year can lead to some tank heat being dumped in the solar panel, which should be avoided.

Prioritise charging of: **External heat source/X-volume**

This is where you indicate whether the tank for the external heat source or the X-volume (acc. tank) should be prioritised when charging (shown only if alternate charging has been defined).

Flow l/min **6.0 (0.1 – 50.0)**

The flow circulating through the solar collectors should be indicated here. (This can be read from the flow meter in the system unit.) The flow must be read when the solar panel pump is running at 100%. NB: The flow is used as the basis for calculating the power and cumulative energy. Incorrect flows will therefore produce incorrect values for these parameters. The pump can be set manually to 100% flow in the menu: Installer/Service/Function test to take a reading.

11.11.2 Panel protection functions

This is where you set the functions that protect the solar panels from over temperatures and the risk of freezing.

Over temp protection panel **Yes (Yes/No)**

The protection function is activated here to protect the solar panel against over temperatures. This is done by cooling the solar panel.

-max panel temp °C **120 (100–150)**

The maximum temperature that the panel may reach is indicated here; the cooling function starts once it has been reached. When cooling is active, heat is dumped
1) in the borehole if there is borehole recharging and
2) then in the tanks up to their maximum permitted temperature.

When the temperature in the solar panel goes above 120°C, the circulation pump will start and the text “cooling panel” will be displayed in operation data.

When the temperature in the solar panel drops, but remains high in the tank: The circulation pump will continue to run and the text “cooling tank” will be displayed in operating data. This will continue until the tank has reached 60 °C.

(Charge temperature, factory setting.)

Cool over temp in tank **No (No/Yes)**

If energy has been transferred to the tank in order to cool the panel, the function to cool the tank by conveying energy to the panel is activated here. This is to enable the system to receive panel cooling (e.g. on the next day).

-Tank cools down to °C **70 (50–80)**

This specifies the temperature that the tank is to be cooled to once it has reached over temperature. When this happens, “extra cooling” will be displayed in operation data.

Antifreeze protection panel **No (No/Yes)**

In the winter, at extremely cold outdoor temperatures there is a risk of the panels freezing (despite antifreeze fluid). The function to take heat from the tank to the panel is activated here.

-Active when panel temp °C **-25 (-30--7)**

This specifies the temperature in the solar collector at which the frost protection starts. When the panel sensor shows a temperature below the frost protection limit, the charge pump starts until the sensor temperature is 2 degrees warmer than the limit value (hysteresis 2 °C).

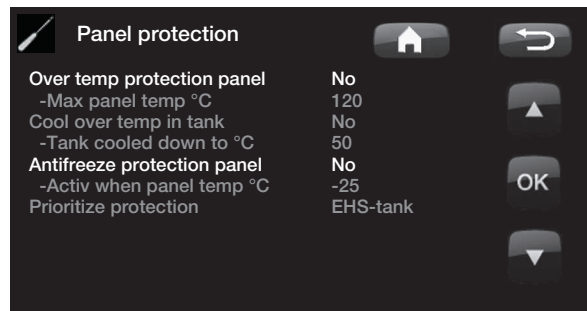

Prioritise protection **EHS tank / X volume**

This is where the specific tank that the protection functions should protect is indicated.

This is only applicable if system 3/X-volume is activated.

11.11.3 Settings EHS tank

Settings applicable when only EHS tank is activated (applies to systems 1 and 3).

Charge temperature °C **60 (10–95)**

Setting for the maximum permitted temperature in the EHS tank. Charging stops once the set temperature has been reached.

Maximum permitted tank temp, °C **70 (60–125)**

If the solar panel temperature exceeds “max panel temp”, energy is allowed to be transferred to the panel up to this set tank temperature.

Check that the protection function “Over temp protection panel” is activated.

11.11.4 EcoTank settings

Settings applicable when EcoTank is activated. This is also called system 2.

Charge temperature °C **60 (10–70)**

Setting for the maximum permitted temperature in the EcoTank. Charging stops once the set temperature has been reached.

Maximum tank temp °C **70 (60–80)**

If the solar panel temperature exceeds its maximum set temperature, energy is permitted to be transferred to the tank up to this set tank temperature.

Check that the protection function “Over temp protection panel” is activated.

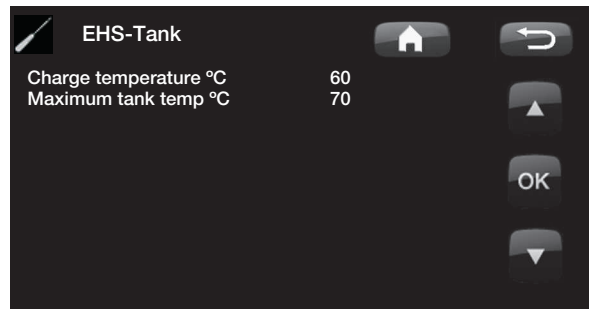
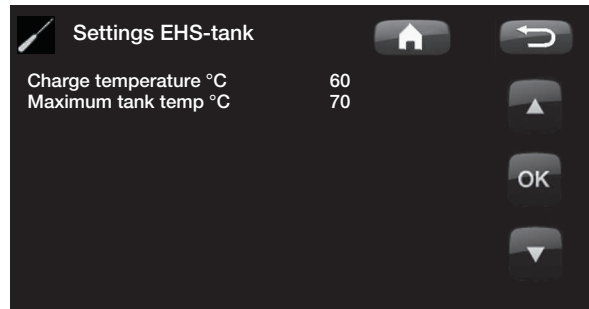

11.11.5 Settings X-volume

Settings applicable when X-volume is activated.

This is also called system 3.

Charge temperature °C 60 (10–95)

The maximum permitted temperature is set in the X-volume. Charging stops once the set temperature has been reached.

Maximum tank temp °C 70 (60–125)

If the solar panel temperature exceeds its maximum set temperature, energy is permitted to continue to be transferred to the tank up to this set tank temperature. Check that the protection function “Over temp protection panel” is activated.

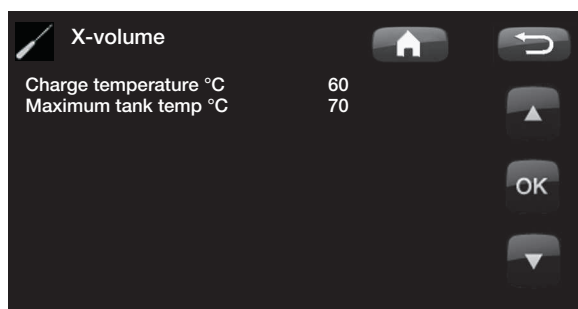

11.11.6 Recharging of bedrock settings

Recharging active No (No/Yes)

The “recharging of borehole” function is activated here. The function is designed to protect the solar panel against over temperatures, but it can also charge the bore hole with energy.

-Charge start diff temp, °C 60 (3–120)

Here you can set the temperature difference at which charging of the bore hole should start. The solar panel must be this many degrees warmer than the brine in the borehole for charging to start. If the panel is charging or can charge the tank, tank charging is prioritised.

-Charge stop diff temp, °C 30 (1–118)

Here you can set the temperature difference at which charging of the bore hole should stop. When the temperature difference between the solar panel and the brine falls below this set value, the charging stops.

-Max permitted brine temp °C 18 (1–30)

Setting for the maximum permitted brine temperature. Charging of the borehole ceases when this value has been reached.

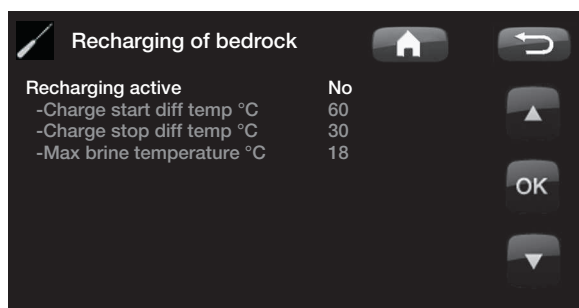

11.11.7 Charging EHS-tank

This function concerns charging conditions between EcoTank and EHS-tank in solar system 2.

This function CANNOT be combined with the “Diff thermostat function”.

Charge start diff temp °C **7 (3–30)**

Here you can set the temperature difference determining when charging to the EHS tank should start. The EcoTank in system 2 must be this many degrees warmer than the EHS tank for charging to start.

Charge stop diff temp °C **3 (2–20)**

Here you can set the temperature difference determining when charging to the EHS tank should stop. When the temperature difference between the EcoTank and the EHS tank falls below this set value, charging stops.

Charge temperature °C **60 (10–80)**

Setting for the maximum permitted temperature in the EHS tank. Transfer stops once the set temperature has been reached.

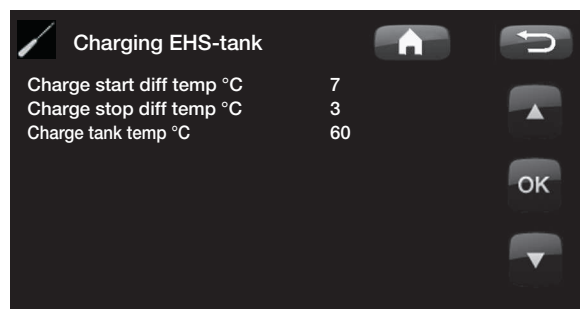

11.12 Diff thermostat function

The diff thermostat function is used to transfer heat from a tank with a sensor (B46) to a tank with a sensor (B47).

The function compares the temperatures in the tanks and when it is hotter in tank B46, charging in tank B47 starts.

However, this function cannot be combined with the same function in a solar heating system (when e.g. an EcoTank is connected). This is because the same outlets and sensors are used for both functions.

Charge start diff temp, °C **7 (3–30)**

Here you can set the temperature difference determining when charging to the EHS tank should start. The temperature must be this many degrees warmer than the EHS-tank for charging to start.

Charge stop diff temp, °C **3 (2–20)**

Here you can set the temperature difference determining when charging to the EHS tank should stop. When the temperature difference falls below this set value, charging stops.

Charge temperature °C **60 (10–95)**

Setting for the maximum permitted temperature in the EHS tank. Transfer stops once the set temperature has been reached.

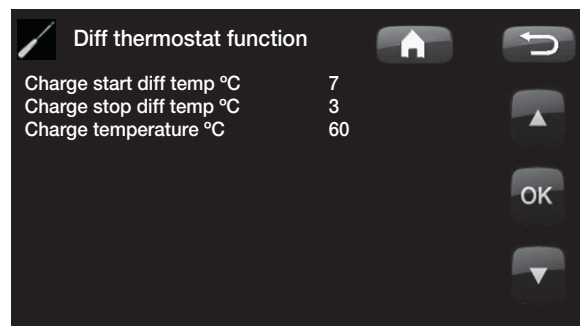

Ensure a high flow on the pump (G46) so that a low temperature difference of approx. 5–10°C is achieved over the EHS tank during charging.

11.13 Pool (accessory)

Pool temp °C 22(5–58)

The pool temperature is set in this menu.

Pool diff °C 1.0(0.2–5.0)

The permitted difference between the start and stop temperature in the pool is specified here.

Max time Pool 20(10–150)

When there is a need for pool heating and heating/hot water, the maximum time for pool heating is shown here.

Charge pump % 50(0–100)

The charge pump speed is set here.

Smart low price. °C 1 (Off, 1–5)

Read more in the “Smartgrid” section.

Smart over capacity °C 2 (Off, 1–5)

Read more in the “Smartgrid” section.

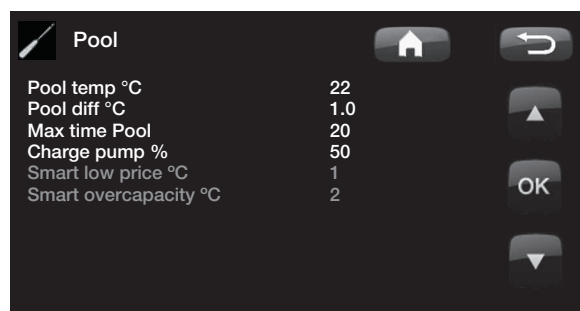

11.14 External heat source (EHS)

Charge start °C 70

This is the minimum temperature required in the external heat source tank (B47) for the mixing valve to open and emit heat to the system.

Stop diff (°C) 5

Temperature difference before charging stops from the extra heating source.

Smart block cap. Off(On/Off)

The mixing valve on the EHS tank turns off and heat energy accumulates until over capacity ceases.

Read more in the “Smartgrid” section.

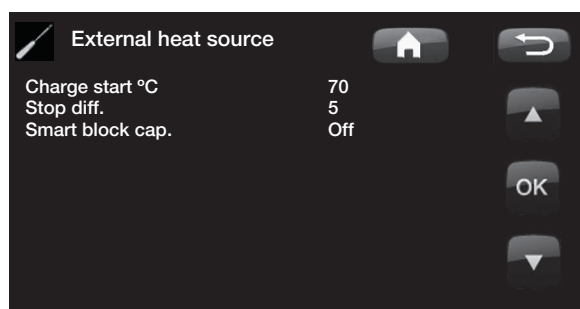

11.15 EcoVent (accessory)

EcoVent

The menu becomes active once the CTC EcoVent ventilation product has been defined. For information on possible settings, please refer to the CTC EcoVent manual.

Save settings

Here your own settings can be stored; confirm with the "OK" button.

Load settings

The saved settings can be reloaded using this option.

Load factory settings

The product is supplied with the factory values set. They can be restored by activating this function. Press OK to confirm. The language, product and product size are retained.

11.16 Define system



You can use this option to define your heating circuit and how it is controlled, with or without a room sensor. The heat pump's flow switch is defined.

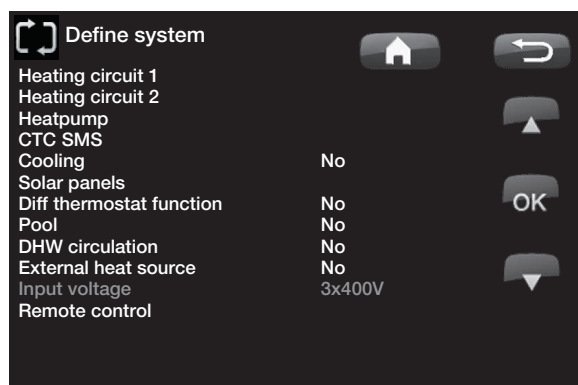

Define heating circuits 1 and 2

Specify whether the room sensor should be connected to the system.

Select whether the room sensor for the heating circuit is connected or wireless. (*Cable/Wireless*).

For the wireless room sensor, refer to the relevant manual.

Once the CTC SmartControl accessory has been installed/defined, a sensor from the CTC SmartControl series can also be used as a room sensor. In such a case, *SmartControl* must be selected from the *Type* menu. For CTC SmartControl functionality and settings, please refer to the relevant manual.

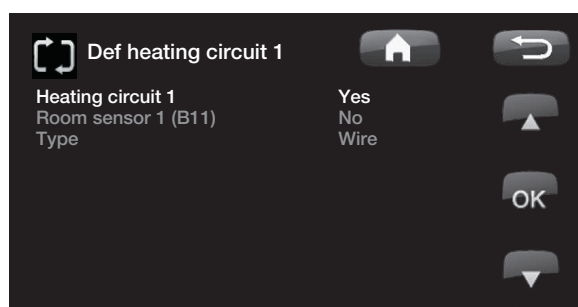

Define heat pump

Flow/level switch **None/NC/NO**
Specify whether or which type of level switch is installed in the system.

Choose between:

- *None*
- *NC (Normally Closed)*
- *NO (Normally Open)*.

Flow/level switch must also be set. See the "Procedure for remote control" chapter.

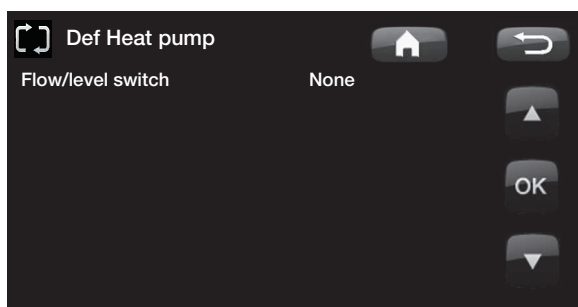

11.16.1 Define SMS (accessory)

This is for defining whether SMS control is installed (accessory).

Activate **Yes (Yes/No)**

If "Yes", the menus below will be displayed.

Level of signal

The signal strength of the reception is shown here.

Phone Number 1

The first activated phone number is shown here.

Phone Number 2

The second activated phone number is shown here.

Hardware Version

The hardware version of the SMS accessory is shown here.

Software version

The software version of the SMS accessory is shown here.

NB: For more information on the SMS function, see the "CTC SMS" manual.

11.16.2 Define cooling (accessory)

The cooling function is adjusted using primary flow sensor 2 (B2), which means that heating circuit 2 and cooling cannot be used simultaneously.

Cooling **No (No/Yes)**

This is for selecting whether cooling is installed.

NOTE! See the CTC EcoComfort manual for more information.

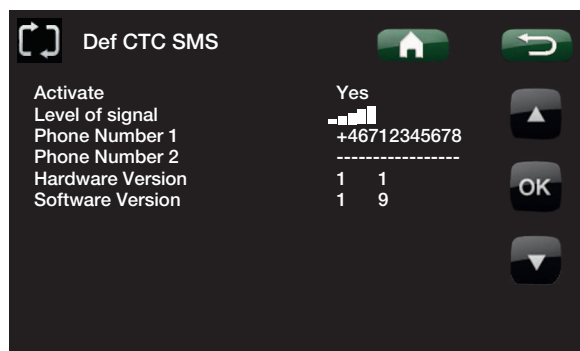

11.16.9 Def. Solar panels (accessory)

Solar panels used **No (No/Yes)**

Specify here whether solar panels are used.

Recharge bedrock **No (No/Yes)**

Specify here whether recharging to bedrock (bore hole) or ground coil is installed (only possible for ground source heat pumps).

Alternate charging **No (No/Yes)**

This function activates system 3.

The function lets you choose to prioritise charging of the external heat source (EHS) or X-volume.

EcoTank **No (No/Yes)**

This function activates system 2 with EcoTank buffer tank (or equivalent).

Panel connected to **Heat exchanger (coil/exchanger)**

Specify here whether there is a solar coil in the EcoTank or an intermediate exchanger is installed.

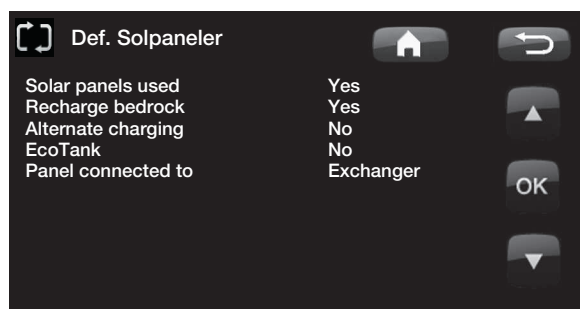

11.16.3 Define Diff thermostat function (accessory)

Specify here whether the diff thermostat function is to be used in the system.

Diff thermostat function **No (No/Yes)**

11.16.4 Define Pool (accessory)

Pool **No (No/Yes)**

Specify here whether Pool should be connected to the heating circuit.

The expansion card accessory (A3) needs to be installed for this function.

11.16.5 Define DHW circulation (accessory)

DHW circulation **No (Yes/No/DHW)**

Set this if hot water circulation with circulation pump G40 is to be used.

Yes. This functionality option requires the Expansion Card (A3) accessory in order for DHW circulation to be checked by the product.

DHW. Alternative with external DHW pump which is not controlled by the product. Does not require expansion card (A3).

11.16.6 Define External heat source (EHS)

External heat source **No(Yes/No)**

Specify here whether an external heat source is connected to the heating circuit.

11.16.7 Define CTC EcoVent (accessory)

EcoVent **EcoVent 20**

The CTC EcoVent ventilation product is defined here. For more information, please refer to the CTC EcoVent manual.

11.16.8 Define CTC SmartControl (accessory)

SmartControl

CTC SmartControl components are defined in this menu. For CTC SmartControl functionality and settings, please refer to the relevant manual.

11.17 Define remote control

The remote control function in CTC's products provides a wide range of opportunities to adjust the heating externally. There are four programmable inputs that can activate the following functions:

- Heat pump tariff
- Immersion heater tariff
- Night reduction
- Ripple control
- Extra domestic hot water
- Flow/level switch
- Heating from HS1
- Heating from HS2
- Smart A
- Smart B
- Reduced, Forced and Customised ventilation as well as Away mode. Applies to the CTC EcoVent 20 ventilation product.

Terminal blocks – inputs

On the relay card (A2) there are 2 inputs of 230V and 2 potential-free inputs (extra low voltage < 12V) that can be programmed.

Open circuit = no external effect.

Closed circuit = active function externally.

Designation	Terminal block position	Connection type
K22	A14 & A25	230 V
K23	A24 & A25	230 V
K24	G33 & G34	Potential-free input
K25	G73 & G74	Potential-free input

11.18 Remote control procedure

Assign input

First of all, an input is assigned to the function or functions to be controlled remotely.

This is done in the *Installer/Define system/Remote control* menu.

Example

In this example, there is manual control of whether the heating is to be on or off in Heating Circuit 1 (HS1).

First of all, "*Heating, ext mode HS1*" is assigned to input K24.

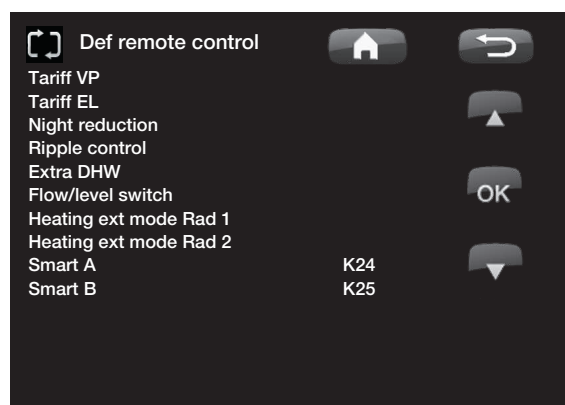

NB:

Enertech AB is NOT responsible for the required heat being produced if the remote control has blocked the heating over a long period.

Activate/select function.

When an input is assigned, the function must be activated or set in the *Installer/Settings/Heating Circuit* menu.



Normal mode can be defined here (arrow 1). Here, the normal mode has been selected as: *Heating mode: On*

When this is done, you programme what is to happen at */Remote Control/Heating, external mode HS1* (closed input, arrow 2).

Arrow 2 indicates the selection "Off".

In this example the heating is always on. (Normal mode). However, when terminal block K24 is closed, "Off" is activated and the heating is switched off. The heating remains switched off until you choose to start heating up by opening K24.

Heating circuit		Home	Back
Max primary flow °C	60		
Min primary flow °C	Off		
Heating, mode	Auto		Up
Heating, mode, ext			Down
Heating off, out °C	18		
Heating off, time	120		OK
Inclination °C	50		
Adjustment °C	0		
Night reduction disable °C	-14		
Room temp reduced °C	-2		
or			
Primary flow reduced °C	-3		
Alarm room temp °C	5		
Smart low price °C	1		
Smart over capacity °C	2		
Max time heating	20		
Charge pump %	60		
Drying period mode	Off		
Drying period temp °C	25		

Example in which "Heating mode" is normally "On" in the heating season, but when terminal block K24 is closed, "Off" is activated and the heating is switched off.

The functions in remote control.

Tariff HP

When electricity suppliers use a differentiated tariff, you have the opportunity to block the heat pump when the electricity tariff is high.

Tariff EL

When electricity suppliers use a differentiated tariff, you have the opportunity to block the immersion heater when the electricity tariff is high.

Night reduction

Night reduction means that you reduce the temperature indoors during scheduled periods, for example at night or when you are at work.

Ripple control

Disconnecting the compressor and immersion heater during a certain period which is defined by the electricity supplier (special equipment).

Ripple control is a device which an electricity supplier can fit with the aim of disconnecting high current draw equipment for a short period of time. The compressor and electrical output are blocked when ripple control is active.

Extra domestic hot water

You select this option if you want to activate the Temporary extra DHW function.

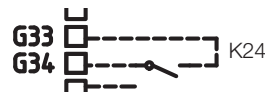

Open terminal block = "On" (in this example)

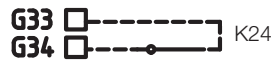

Closed terminal block = "Off" (in this example)

NB: If both the heat pump and the immersion heater are blocked, the building may be without heating for a long time. It is therefore recommended that you only block the immersion heater with the tariff.

Flow/level switch

In some cases, the coolant seal must be additionally protected owing to local requirements or provisions. For example, the requirement in some areas is for the system to be installed within a water catchment area. Pressure/level switch defined in the *Installer/Define system/def. heat pump* menu. If there is a leak, the compressor and brine pump stop and the Flow/level switch alarm appears on the display.

Heating, ext. mode HS1

Heating, ext. mode HS2

With remote controlled "Heating, ext. mode", "On" is selected if the heating is to be on or "Off" if the heating is to be switched off. "Auto" mode can also be selected.

Read more in the section entitled "Your home's heating curve".

Smart A

Smart B

Smart Grid offers an opportunity to control from the outside whether heating is to be calculated as normal price, low price or overcapacity. The heat pump and immersion heater can also be blocked in a way similar to "Ripple control".

Vent. Reduced.

Vent. Forced,

Vent. Adapted,

Vent. Absent

Once the CTC EcoVent 20 ventilation product has been installed/defined, these ventilation functions can be activated. For more information, please refer to the CTC EcoVent manual.

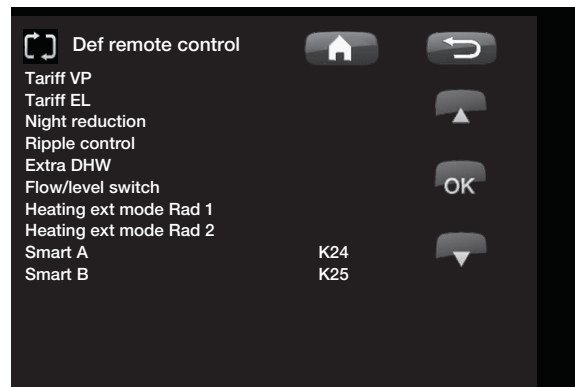

Example in which Smart A has been assigned low voltage input K24 and Smart B has been assigned low voltage input K25.

11.19 Smart Grid

The "Smart Grid" function selects different heating options depending on the price of energy using accessories from the energy supplier.

Smartgrid is based on the energy price being calculated as

- Normal price
- Low price
- Overcapacity
- Blocking

Room temperature, pool temperature and hot water temperature, etc. are given different heating temperatures depending on the energy price.

Procedure:

First of all, Smart A and Smart B are assigned separate inputs in the *Advanced/Define/Define Remote Control/Smart A/B* menu.

Activation then takes place based on the terminal blocks' closure and settings for each function.

- Normal price: (Smart A: Open, Smart B: Open).
No effect on the system.
- Low price mode: (Smart A: Open, Smart B: Closed).
- Overcapacity mode: (Smart A: Closed, Smart B: Closed).
- Blocking mode: (Smart A: Closed, Smart B: Open)

In each function that can be controlled there is a choice of temperature change for low price mode and overcapacity mode.

Example: factory-set low price 1°C increase* in temperature.

Example: factory-set overcapacity 2°C increase* in temperature.

Smart Low price °C	1(Off, 1-5*)
Smart Overcapacity °C	2(Off, 1-5*)

*DHW tank has setting range 1-30

The following can be controlled:

- Room temperature i heating systems 1-2
- Primary flow temperature in heating systems 1-2
- DHW tank
- Pool
- Cooling
- EHS

Comment re cooling

When active cooling = setpoint has not been reached.

E.g. 26.0 (25.0)

In these cases Smart Grid "Normal mode" is activated for the heating systems. (Smart low price or smart overcapacity is not activated).

The reason for this is to avoid a conflict between heating and cooling. For example, if there is a standard 2 °C difference between heating and cooling, you do not want to heat and cool at the same time.

Low price mode: (A: Open, B: Closed).

- With room sensor: Room temp. (setpoint) increased by 1°C (Factory setting, Smart low price °C)
- Without room sensor: Primary flow (setpoint) increased by 1°C (Factory setting, Smart low price °C)
- DHW tank: Setpoint increased by 10°C (Factory setting, Smart low price °C)
- Pool: Pool temp. increased by 1°C (Factory setting, Smart low price °C)
- Cooling. Room temperature reduced by 1°C (Factory setting, Smart low price °C)

Blocking mode: (A: Closed, B: Open).

- The heat pump and immersion heater can be blocked in accordance with the settings in heat pump and immersion heater.
- Smart blocking HP No (Yes/No)
Blocks heat pump
Installer/Settings/Heat pump
- Smart blocking immersion heater No (Yes/No)
Blocks immersion heater
Installer/Settings/Immersion Heater

Overcapacity mode: (A: Closed, B: Closed).

- With room sensor: Room temp. (setpoint) is increased by 2°C (Factory setting, Smart overcap. °C)
- Without room sensor: Primary flow (setpoint) is increased by 2°C (Factory setting, Smart overcap. °C)
- DHW tank: Immersion heater
Setpoint is increased by 10°C. The immersion heater is permitted to run in parallel with the heat pump (Factory setting, Smart overcap. °C).
- Pool: Pool temp. is increased by 2°C (Factory setting, Smart overcap. °C)
- Cooling. Room temperature is reduced by 2°C
- EHS. Can be blocked in
Installer/Settings/External heat source

11.20 Service



! NB: This menu is intended for the installer only.

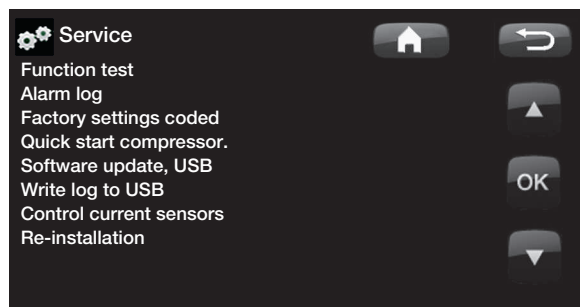

11.20.1 Function test

This menu is intended to test the function of the various components in the product. When the menu is activated, all the product's functions stop. Each component can then be tested separately or together. All control functions are shut off. The only protection against incorrect operation are pressure sensors and the electric heater's superheat protection. When you exit the menu, the heat pump returns to normal operation. If no button is pressed for 10 minutes, the product automatically returns to normal operation.

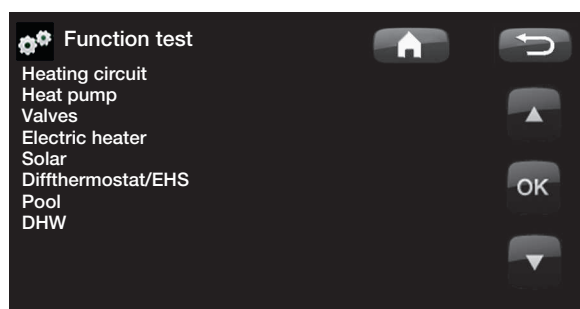

! When you exit the menu, the heat pump returns to the start menu.

Test Heating circuit

Tests for heating circuit 2, if one is installed.

Mixing valve 2

Opens and closes the mixing valve.

Rad pump 2

Starts and stops the radiator pump (G2).

LED room sensor

The room sensor alarm function can be controlled from here. When activated, the room sensor's red LED comes on steady.

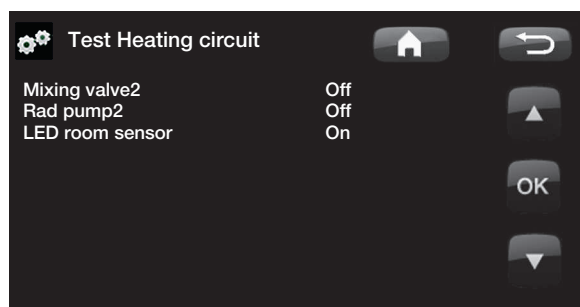

Test heat pump

Function test carried out on the heat pump.

HP Compr.

Compressor On/Off. This is where the function test is carried out on the compressor. The brine pump and charge pump are also operating so that the compressor will not trigger its pressure switches.

HP Brine p (G20)

Brine pump On/Off.

HP Charge p. (G11)

Function test 0-100%

Test Valves

Function test carried out on the flow conditioner (Y21).

Test of flow to hot water or to the heating circuit.

HC = Heating Circuit

DHW = Domestic Hot Water

Test Electric heater

You use this function to test the electric heater's various phases L1, L2 and L3.

Immersion heater L1A **Off (Off/On)**

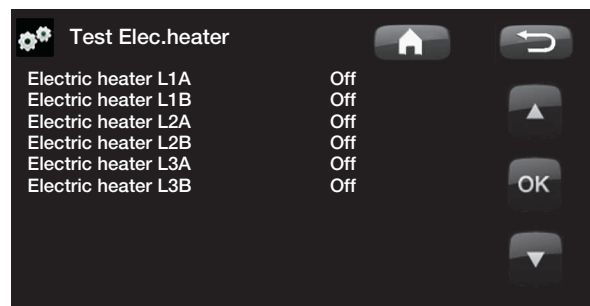
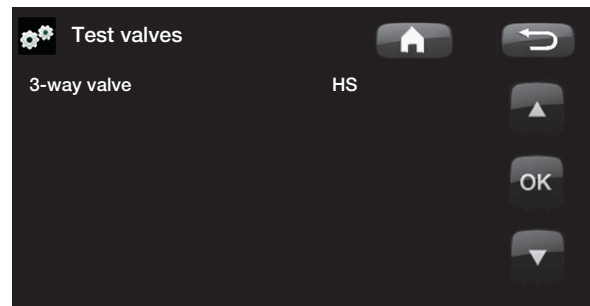
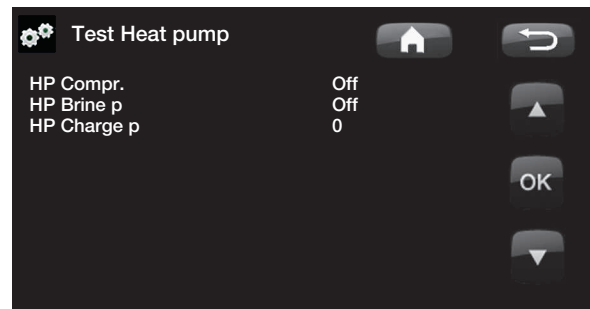

Test Solar (accessory)

This function will only work if an expansion card accessory (A3) is connected to the product.

Pump solar panel (G30) % (0–100)

Function test of circulation pump to solar panel 1.

Heat exchanger pump (G32) % (0–100)

Function test of circulation pump to intermediate exchanger.

Borehole charging (Y31/G31) (Tank/Borehole)

Function test of 3-way valve and circulation pump to borehole charging. When “Bedrock” is selected, the flow will go to the bore hole, and the circulation pump (G31) will start. When “Tank” is selected, (G31) should be closed.

Valve 2 tanks (Y30) (EHS tank/X-volume)

Function test of 3-way valve between the tanks.

Pump EHS tank (G46) (Off/On)

Function test of circulation pump to tank transfer.

Temperatures

This displays current temperatures.

Solar panels in (B30)

Solar panels out (B31)

EHS-tank (B47)

EcoTank upper (B41) / lower (B42)

or:

X-vol. upper (B41) / lower (B42)

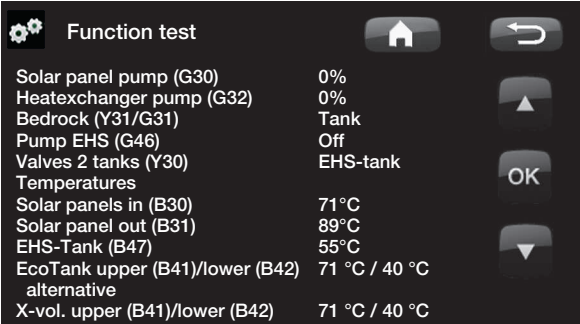

Function test	
Solar panel pump (G30)	0%
Heatexchanger pump (G32)	0%
Bedrock (Y31/G31)	Tank
Pump EHS (G46)	Off
Valves 2 tanks (Y30)	EHS-tank
Temperatures	
Solar panels in (B30)	71 °C
Solar panel out (B31)	89 °C
EHS-Tank (B47)	55 °C
EcoTank upper (B41)/lower (B42)	71 °C / 40 °C
alternative	
X-vol. upper (B41)/lower (B42)	71 °C / 40 °C

Test Diff thermostat/EHS

Pump EHS (G46) (On/Off)

Charge pump function test.

Mixing valve (Y41) (- /Open/Close)

Temperatures

This displays current temperatures.

EHS-tank °C (B47)

Diff thermostat °C (B46)

Test Pool (accessory)

Pool pump/Valve (G51)/(Y50) (On/Off)

Test of pool pump and valve.

Temperatures

This displays current temperatures.

Pool (B50)

Displays current pool temperature.

Test DHW

DHW pump (G5) 0% (0—100)

Function test of the tap water pump for hot water.

DHW circulation pump (G40) (On/Off)

Test of hot water circulation pump.

Sensor

DHW °C (B25)

Displays current hot tap water temperature.

Flow sensor (B102) (On/Off)

Shows whether there is a flow in the DHW pipe.

Test EcoVent (Accessory)

EcoVent

Testing the CTC EcoVent ventilation product. For more information, please refer to the CTC EcoVent manual.

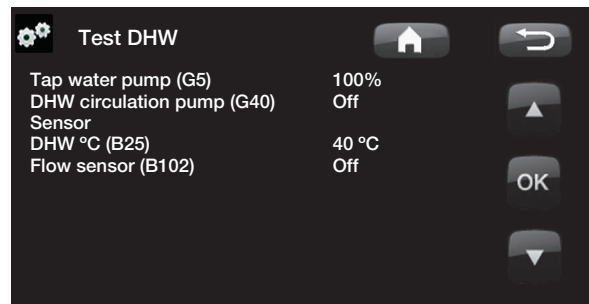

11.20.2 Alarm log HP

You can use this to read information about the latest alarms. The latest alarm is displayed at the top and the four latest alarms are shown under Stored alarms.

An alarm which reoccurs within an hour is ignored so as not to fill up the log. If all the alarms are the same, this can indicate that there is an intermittent fault, e.g. a loose contact.

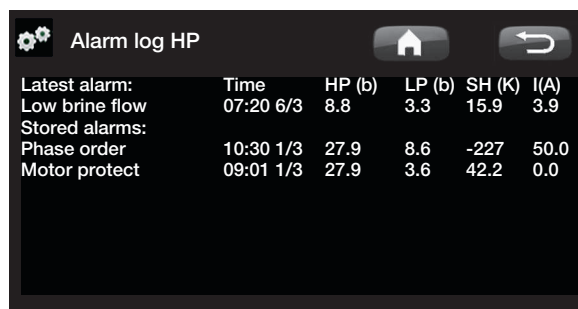

Latest alarm:	Time	HP (b)	LP (b)	SH (K)	I(A)
Low brine flow	07:20 6/3	8.8	3.3	15.9	3.9
Stored alarms:					
Phase order	10:30 1/3	27.9	8.6	-227	50.0
Motor protect	09:01 1/3	27.9	3.6	42.2	0.0

! NB: Only an authorised service engineer is allowed to log into the Factory settings coded option. Severe operational problems and faults may occur affecting the product if values are amended without authorisation. Note that in such cases the warranty terms do not apply.

11.20.3 Coded settings

This menu is intended to set the manufacturer's operational and alarm limits. A 4-digit code must be specified to be able to amend these limits. However, you can also take a look without any code to see what options feature in the menu.

Coding in the case of a BBR (Boverkets Byggregler) installation

On installation in a newly built dwelling, the regulations of the Swedish National Board of Housing, Building and Planning (Boverket) must be adhered to when setting maximum power output. In such a case the installer must enter the four figure code 8818, which will lock the installed maximum power once the 8818 code is changed to a different one.

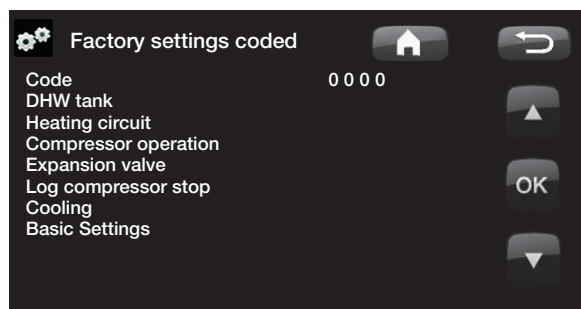

Code	0 0 0 0
DHW tank	
Heating circuit	
Compressor operation	
Expansion valve	
Log compressor stop	
Cooling	
Basic Settings	

11.20.4 Quick start compressor

When starting up the product, the compressor's start is delayed by 10 minutes. This function speeds up this process.

11.20.5 Software update, USB

This is only for service engineers. This option can be used to update the software in the display via USB. The software update process is complete when the start menu appears.

11.20.6 Write log to USB

This is only for service engineers. This function can be used to save logged values to a USB memory stick.

11.20.7 Control current sensors

This is for identifying which current sensor is connected to the relevant phase.

All three currents (L1, L2 and L3) will appear in the current operation data when the heat pump has identified the current transformers' relevant phases.

In this situation it is important that you have switched off any major consumers of electricity in the house. Also make sure that the backup thermostat is turned off.

11.20.8 Re-installation

This command re-launches the installation sequence (see the section entitled "First start").

 NB: The power to the product must not be interrupted, under any circumstances, during the update process.

 NB: Turn off the power and always restart the product after software update. Several minutes may pass before the display communicates clearly after restart.

12. Troubleshooting/appropriate measures

The heat pump is designed to provide reliable operation and high levels of comfort, and to have a long service life. Various tips are given below which may be helpful and guide you in the event of an operational malfunction.

If a fault occurs, you should always contact the installer who installed your unit. If the installer believes the malfunction is due to a materials or design fault, then they will contact us to check and rectify the issue. Always provide the product's serial number.

DHW

Many people want to gain maximum benefit from the heat pump's low operating costs.

The control system is equipped with three comfort levels for DHW. We recommend starting at the lowest level and if there is not enough hot water, increase it to the next level. We also recommend that you operate a regular DHW pattern.

Check that the DHW temperature is not being affected by a poor mixing valve, whether at the heat pump or possibly the shower mixer.

The heating system

The room sensor (accessory), which should be fitted when possible, ensures that the temperature in the room is always suitable and stable. For the sensor to provide the correct signals to the control unit, radiator thermostats should always be fully open in the area where the room sensor is located.

A correctly operating heating circuit is of significant importance to the heat pump's operation and affects energy savings.

■ Avoid running DHW at the highest flow capacity. If you run a bath at a rather slower rate instead, you will get a higher temperature.

■ Avoid placing the room sensor close to the stairway due to the uneven air circulation.

■ If you do not have radiator thermostats on the upper floor, you may need to install them.

When adjusting the system, always do so with all radiator thermostats fully open. The thermostats can be individually adjusted after a few days in the other rooms.

If you do not achieve the set room temperature, check:

- That the heating circuit is correctly adjusted and is functioning normally. That radiator thermostats are open and the radiators are equally warm all over. Touch the entire radiator surface. Bleed the radiators. In order for the heat pump to run economically, the heating circuit must function well in order to provide good savings.
- That the heat pump is operating and no error messages are displayed.
- That there is sufficient electrical power available. Increase if necessary. Also check that the electric power output is not limited due to excessively high electricity loads in the property (load monitor).
- That the product is not set to the “Max. permitted primary flow temperature” mode with a too low value.
- That “Primary flow temperature at -15°C outdoor temperature” is set sufficiently high. Increase if necessary. More can be read about this in the section entitled “The property’s heating curve”. However, always check the other points first.
- That the temperature reduction is set correctly. See Settings/Heating circuit.

If heating is uneven, check (if the room sensor accessory is installed):

- That the placement of the room sensors is appropriate for the house.
- That the radiator thermostats don't interfere with the room sensor.
- That no other heat sources/cold sources interfere with the room sensor.

Current monitor

The heat pump has an integrated current monitor. If the system is fitted with a current sensor, the property’s main fuses are continuously monitored to ensure they are not overloaded. If this should happen, electric stages are disconnected from the heat pump. The heat pump may be restricted where high heating requirement levels are combined with, for example, single-phase engine heaters, cookers, washing machines or tumble dryers. This may result in inadequate heating or DHW temperatures. If the heat pump is limited, “High current, elpower redu (X A)” appears in text form in the display. Consult an electrician to determine whether the fuse size is correct or the three phases in the house are evenly loaded.

Ground loop

Faults can occur in the cooling unit if the ground loop has not been installed correctly, if it has not been bled sufficiently, if it contains too little antifreeze or is not designed to an adequate size. Poor or insufficient circulation can result in the heat pump triggering an alarm in the case of low evaporation. If the temperature difference between the ingoing and outgoing temperature is too large, the product triggers an alarm and “Low brine flow” is displayed. The probable cause is that there is still air in the brine circuit. Bleed thoroughly, which may in some cases take up to a day. Also check the ground loop. See also the section entitled “Connecting the brine system”. Reset the Low evaporation alarm on the display. Where a malfunction repeatedly occurs, call in a technician to investigate and rectify the fault.

If the text “Low brine temp” is displayed, the ground loop may not be large enough or there may be a fault with the sensor. Check the brine circuit temperature in the Operation data menu. If the incoming temperature falls below -5 °C during operation, call in a technician to inspect the brine circuit.

Air problems

If you hear a rasping sound from the heat pump, check that it is properly bled. Top up with water where required, so that the correct pressure is achieved. If this noise recurs, call a technician to check the cause.

Unusual noise when shutting off DHW

In some cases, unusual noises may be produced by the cold water, pipe work and heat pump due to the jolts which occur when the flow is quickly interrupted. There is no fault with the product, but the noise may occur when older types of instant closing mixers are used. More recent types are often fitted with a soft-closing mechanism. If an unusual sound comes from hard-closing dishwasher and washing machines, this can be remedied using a shock arrestor. A shock arrestor can also be an alternative to soft-closing water taps.

The cause of the fault may be as follows:

- Phase failure or mains interruption. Check the fuses, which are the most common cause.
- Compressor overload. Call out a service engineer.
- Faulty compressor. Call out a service engineer.
- Circulation too poor between the cooling circuit and cylinder. Check the heat medium pump (left pump).
- Abnormally high temperature in the brine circuit. Call out a service engineer.

■ Don't forget that the radiators may also need bleeding.

12.1 Information messages

Information messages are displayed when appropriate and are intended to inform users about various operational situations.



[I013] Start delay

[I002] Heating off, heating sys. 1

[I005] Heating off, heating sys. 2

Indicates that the product is in Summer mode. No need for heating in the current heating system, only hot water.

[I008] Tariff, HP off.

Indicates that Tariff has switched off the heat pump.

[I009] Compressor locked

The compressor is set to be shut down, e.g. before drilling or digging has been carried out for the collector circuits. The product comes with the compressor shut off. This option is selected under the Installer/Settings/Heat pump menu.

[I010] Tariff, EI off.

Indicates that Tariff has switched off the immersion heater.

[I011] Ripple control

Indicates that ripple control is active. Ripple control is a device which can be fitted by an electricity supplier in order to disconnect equipment with a high rate of electricity consumption for a short period of time. Not currently in use in the UK. The compressor and electrical output are blocked when ripple control is active.

[I012] High current, reduced electricity

- The property's main fuses risk being overloaded due to, for example, the simultaneous use of several power-hungry appliances. The product reduces the immersion heaters' electrical output during this period.
- 2h max. 6 kW. Electric heating elements are limited to 6 kW for 2 hours after being switched on. This message appears if more than 6 kW are required during the product's first 2 hours of operation. This is applicable after a power outage or a new installation.

[I013] Start delay

The compressor is not allowed to start too quickly after it has stopped. The delay is usually at least 10 minutes.

[I014] Drying period active, d

Indicates that the floor function is active and displays the time (days) remaining that the function will be active.

Smart: [I019] low price/ [I018] overcap./[I017] blocking

Product functionality is governed by "Smartgrid". Also see *Define system/Remote control/Smartgrid*.

[I021] Heating, ext. mode HC 1**[I022] Heating, ext. mode HC 2**

Remote control governs whether the heat in the heating system is to be switched on or off. If the heating is switched off, "Heating off, heating circuit 1/2" is also displayed.

[I028] Holiday period

Displayed when setting the holiday schedule, which entails lowering the room temperature and that no hot water is produced.

[I029] Bleeding DHV in progress

During the bleeding process, hot water will not be delivered at a continuous temperature. Hot water production is allowed to start when the bleeding process has stopped and the information message is no longer displayed .

[I030] Driver block under voltage

The heat pump has stopped due to under voltage. The product will make a new attempt to start.

[I031] Driver block larm

The heat pump has stopped due to a driver fault; for example over voltage or too high temperature. The product will make a new attempt to start.

12.2 Alarm messages

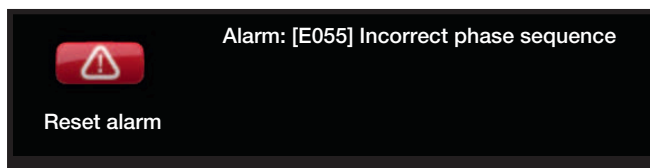

If a fault occurs with e.g. a sensor, an alarm is triggered. Text appears on the display with information about the error.

You reset the alarm by pressing the Reset Alarm button on the display.

If several alarms are triggered, they are displayed one after the other. A persisting fault must first be rectified before it can be reset. Some alarms are reset automatically if the fault ceases.

Alarm messages	Description
[E010] Compressor type ?	This message appears if no information about the compressor type is available.
[E013] EVO off	This message appears when there is a fault with the expansion valve control.
[E024] Fuse blown	This message appears when the fuse (F1, F2) has been triggered.
[E026] Heat pump	This message appears if the heat pump is in alarm mode.
[E027] Communication error HP	This message appears if the display card (A1) is unable to communicate with the HP control card (A5).
[E063] Comm. err. relay board	This message appears if the display card (A1) is unable to communicate with the relay board (A2).
[E063] Comm. err. motor protection	This message appears if the HP control card (A5) is unable to communicate with the motor protection (A4).
[E086] Comm. err. expansion card	This message appears if the display card (A1) is unable to communicate with CTC Solar Control/Expansion Card (A3).
[E035] High pressure switch	The refrigerant's high pressure switch has been triggered. Press reset and check whether the alarm recurs. If the fault recurs, contact your installer.
[E040] Low brine flow	Low brine flow is often caused by air in the collector system, especially immediately following installation. Collectors which are too long can also be a cause. Press reset and check whether the alarm recurs. Also check the brine filter that has been installed. If the fault recurs, contact your installer.
[E041] Low brine temp.	Incoming brine temperatures from bore hole/ground loop are too low. Press reset and check whether the alarm recurs. If the fault recurs, contact your installer to check the positioning of the cold side.
[E044] Stop, high comp. temp.	This message appears when the compressor temperature is high. Press reset and check whether the alarm recurs. If the fault recurs, contact your installer.
[E045] Stop, low evaporation	This message appears when the evaporation temperature is low. Press reset and check whether the alarm recurs. If the fault recurs, contact your installer.
[E046] Stop, high evaporation	This message appears when the evaporation temperature is high. Press reset and check whether the alarm recurs. If the fault recurs, contact your installer.

Alarm messages	Description
[E047] Stop, low suct. gas exp. valve	This message appears when the suction gas temperature is low. Press reset and check whether the alarm recurs. If the fault recurs, contact your installer.
[E048] Stop, low evap. exp. valve	This message appears when the expansion valve's evaporation temperature is low. Press reset and check whether the alarm recurs. If the fault recurs, contact your installer.
[E049] Stop, high evap. exp. valve	This message appears when the expansion valve's evaporation temperature is high. Press reset and check whether the alarm recurs. If the fault recurs, contact your installer.
[E050] Stop, low overheat. exp. valve	This message appears when the expansion valve's overheat temperature is low. Press reset and check whether the alarm recurs. If the fault recurs, contact your installer.
[E052] Phase 1 missing [E053] Phase 2 missing [E054] Phase 3 missing	This message appears in the event of a phase failure.
[E055] Incorrect phase sequence	The product's compressor motor must rotate in the right direction. The product checks that the phases are connected correctly; otherwise, an alarm is triggered. This will require changing two of the phases into the product. The power supply to the system must be shut off when rectifying this fault. This fault generally only occurs during installation.
[Exxx] 'sensor'	An alarm message is displayed if an error occurs with a sensor that is not connected or has short-circuited and if the value is outside the sensor's range. If this sensor is important to the system's operation, the compressor stops. This requires the alarm to be reset manually after the fault has been rectified. For the following sensors, the alarm is reset automatically after correction: [E012] DHW tank sensor (B5), [E140] EHS tank sensor (B47), [E031] Primary flow sensor 1 (B18), [E032] Primary flow sensor 2 (B2), [E030] Outdoor sensor (B15), [E074] Room sensor 1 (B11), [E075] Room sensor 2 (B12), [E005] Brine out sensor, [E003] Brine in sensor, [E028] HP in sensor, [E029] HP out sensor, [E037] Hot gas sensor, [E080] Suction gas sensor, [E036] High pressure sensor, [E043] Low pressure sensor.
[E057] High current motor protection	High current into the compressor has been detected. Press reset and check whether the alarm recurs. If the fault recurs, contact your installer.
[E058] Low current motor protection	Low current into the compressor has been detected. Press reset and check whether the alarm recurs. If the fault recurs, contact your installer.
[E061] Max. thermostat	This alarm message appears if the product becomes too hot. During installation, make sure the max. thermostat (F10) has not been triggered as there is a chance of this occurring if the boiler has been stored in extremely cold temperatures, Reset it by pressing in the button on the electrical switchboard behind the front panel.

