



Installation and Maintenance Manual

## CTC EcoZenith i255

400V 3N~/ 230V 1N~/ 230V 3~



Important!

- Read carefully before use, keep for future reference.
- Translation of the original instructions.

# Table of contents

<b>1. Congratulations on your new product!</b> .....	<b>3</b>	<b>11. Troubleshooting</b> .....	<b>79</b>
<b>2. Safety instructions</b> .....	<b>5</b>	11.1 Information messages.....	81
<b>3. Installation</b> .....	<b>6</b>	11.2 Alarm messages.....	82
3.1 Transportation.....	6	11.3 Critical alarms - Risk of freezing.....	85
3.2 Unpacking.....	6	<b>12. Pipe installation</b> .....	<b>87</b>
3.3 Recycling.....	6	12.1 Filling.....	87
3.4 Standard delivery.....	6	12.2 Schematic diagram.....	89
3.5 Control functions (std.) and with expansion card.....	7	12.3 Connection to heat pump.....	93
<b>4. Your home's heating installation</b> .....	<b>9</b>	12.4 Schematic diagram of passive cooling - Combined cooling/heating.....	95
<b>5. Technical data</b> .....	<b>13</b>	12.5 Schematic diagram of passive cooling in separate heating circuits.....	96
5.1 Table 400V 3N~.....	13	<b>13. Electrical installation</b> .....	<b>98</b>
5.2 Table 230V 1N~/230V 3~.....	14	13.1 Electrical installation.....	98
5.3 Measurements.....	15	13.2 Positioning of electrical components.....	99
<b>6. Function description</b> .....	<b>17</b>	13.3 Electrical connection to heat pump.....	100
<b>7. Parameter list EcoZenith i255</b> .....	<b>18</b>	13.4 Extra low voltage protection.....	102
<b>8. Control system</b> .....	<b>20</b>	13.5 Settings to be carried out by the installation electrician..	104
8.1 Quick start touchscreen.....	21	13.6 Connection of pump (G46) to Differential thermostat function.....	107
8.2 Installation wizard.....	23	13.7 Connection of sensor (B46) to Differential thermostat function.....	107
<b>9. Detailed menu descriptions</b> .....	<b>24</b>	13.8 Resistances for sensors.....	107
9.1 Start menu.....	24	13.9 Component list, wiring diagram.....	108
9.2 Alarm management.....	24	13.10 Wiring diagram 400V 3N~.....	109
9.3 Heating/Cooling.....	25	13.11 Wiring diagram 230V 1N~.....	110
9.4 DHW.....	29	13.12 Wiring diagram 230V 3~.....	111
9.5 Ventilation.....	29	<b>14. Installation Communication</b> .....	<b>112</b>
9.6 Schedule.....	30	14.1 Installing the network cable.....	113
9.7 Operation data.....	32	14.2 Remote - Screen Mirroring.....	114
9.8 Display.....	39	14.3 myUplink - App.....	114
9.9 Settings.....	41	<b>15. First start</b> .....	<b>115</b>
9.10 Define.....	61		
9.11 Service.....	74		
<b>10. Operation and Maintenance</b> .....	<b>78</b>		

## Software update



software.ctc.se

EN

For more information on updated functions and downloading the latest software, see the website "software.ctc.se".

# 1. Congratulations on your new product!



You have just purchased a CTC EcoZenith i255, with which we hope you will be very pleased. Read about how you can take care of your boiler on the following pages.

Save this manual containing the installation and maintenance instructions. If it is properly maintained, you will be able to enjoy the use of your CTC EcoZenith i255 for many years. This manual will provide all the information you will need.

## The complete system tank

The CTC EcoZenith i255 is a complete system tank which meets your home's heating and DHW requirements. It has a built-in immersion heater and is equipped with a motorised mixing valve which ensures that correct and even temperatures are supplied to your heating circuit. The CTC EcoZenith i255 has a built-in circulation pump for connection to a heat pump.

CTC EcoZenith i255 is only approved for installation together with the following products.

- CTC EcoAir 708M
- CTC EcoAir 712M
- CTC EcoAir 610M
- CTC EcoAir 614M
- CTC EcoAir 622M
- CTC EcoAir 406
- CTC EcoAir 408
- CTC EcoAir 410
- CTC EcoAir 510M
- CTC EcoAir 520M
- CTC EcoPart 406
- CTC EcoPart 408
- CTC EcoPart 410
- CTC EcoPart 412

Eco design information about the current combination (current package) can be retrieved/downloaded from [www.ctc.se/ecodesign](http://www.ctc.se/ecodesign) where the energy labelling stickers can also be printed.

All controls for the heat pump and charge pump are built into the CTC EcoZenith i255. With this added feature you achieve a very eco-friendly and energy-saving heating system.



Information and energy labelling stickers for the package in question must be handed over to the final consumer.

# Important to remember!

Check the following points at the time of delivery and installation:

- The product must be transported and stored in an upright position. When moving the product, it can be placed temporarily on its back.
- Remove the packaging and check before installation that the product has not been damaged in transit. Report any transport damage to the carrier.
- Place the product on a solid foundation, preferably made of concrete. **If the product is to stand on a soft carpet, plates must be placed under the feet.**
- Remember to leave a service area of at least 1 metre in front of the product.
- The product must not be placed below floor level either.
- Avoid placing EcoHeat in rooms with lightly insulated walls where neighbouring rooms may be disturbed by the compressor and vibrations.
- Register the product for warranty and insurance via the website <https://www.ctc-heating.com/customer-service#warranty-registration>

**!** If these instructions are not followed during the installation, operation and maintenance of the system, CTC's liability under the applicable warranty terms is not binding.

**i** Information in this type of box [i] is intended to help ensure that the product functions optimally.

**!** Information in this type of box [!] is particularly important for correctly installing and using the product.

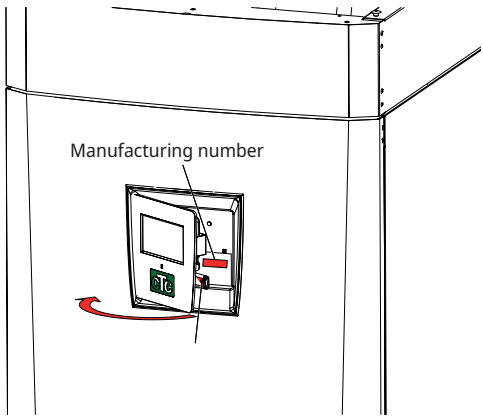

Fill in the information below. It may come in useful if anything should happen.

Product:	Serial no.:
Installer:	Name:
Date:	Tel. no.:
Electrical installer:	Name:
Date:	Tel. no.:

No liability is accepted for any misprints. We reserve the right to make design changes.



## 2. Safety instructions



Turn off the power with an omnipolar switch before doing any work on the product.



The product must be connected to protective earth.



The product is classified as IPX1. The product must not be rinsed with water.



When handling the product with a hoist ring or similar device, make sure that the lifting equipment, eyebolts and other parts are not damaged. Never stand under the hoisted product.



Never jeopardise safety by removing bolted covers, hoods or similar.



Any work on the product's cooling system should be carried out by authorised personnel only.



Installation and connection in the product must be carried out by a authorised electrician. All piping must be installed according to the applicable requirements.

Service of the product's electrical system must only be carried out by a qualified electrician in compliance with the specific requirements of the national standard for electrical safety.

Replacement of damaged supply cable, must be carried out by the manufacturer or qualified service engineer to avoid risk.



Safety valve check:  
-Safety valve for boiler/system to be checked regularly.



The product must not be started if it is not filled with water; instructions are in the "Pipe installation" section.



**WARNING:** Do not switch on the product if there is a possibility that the water in the heater is frozen.



This device can be used by children from the age of eight years and above and by people with reduced physical, sensory or mental ability or lack of experience or knowledge if they have been taught, either with supervision or with the instructions provided, how to use the device safely and understand the risks involved. Children should not play with the device. Cleaning and maintenance should not be carried out by children without supervision.



If these instructions are not followed when installing, operating and maintaining the system, CTC's commitment under the applicable warranty terms is not binding.

## 3. Installation

This section is aimed at anyone responsible for one or more of the installations required to ensure that the product works the way the property owner wants.

Take your time going through functions and settings with the property owner and answer any questions. Both you and the CTC EcoZenith i255 benefit from a user who has completely understood how the system operates and should be maintained.

### 3.1 Transportation

Transport the unit to the installation site before removing the packaging. Handle the product in the following manner:

- Forklift.
- Lifting eye fitted to the lifting sleeve on top of the EcoZenith i255. An extra sleeve can be found in the middle, under the insulation.
- Lifting band around the pallet. **NB:** Can only be used with the packaging on.

Remember that CTC EcoZenith i255 has a high centre of mass and should be handled with caution.

 The product must be transported and stored in an upright position.

### 3.2 Unpacking

Unpack the CTC EcoZenith i255 when it is placed next to its installation site. Check that the product has not been damaged in transit. Report any transport damage to the carrier. Also check that all parts and components are included in the delivery.

### 3.3 Recycling

- The packaging must be deposited at a recycling station or with the installation engineer for correct waste management.
- Obsolete products must be disposed of correctly and transported to a waste station or distributor/retailer offering this service. Disposal of the product as household waste is not permitted.
- It is very important that the product's refrigerant, compressor oil and electric/electronic components are disposed of correctly.

### 3.4 Standard delivery

- CTC EcoZenith i255 system tank with factory-installed charge pump for connection of heat pump.
- Connected electrical cabling  
3 m supply cable, of which 1.1 m is inside the product.  
(3x400V 5Gx6 mm<sup>2</sup> / 1x230V 3Gx10 mm<sup>2</sup> / 3x230V 4Gx10 mm<sup>2</sup>)  
2.5 m primary/return sensor (NTC 22k).
- Packaging includes:
  - \* Installation and maintenance manual
  - \* Outdoor sensor, cable length 15 m
  - \* Room sensor
  - \* Pressure gauge
  - \* Safety valve 9 bar (clean water)
  - \* 3x Current sensors
  - \* 2x cable ties
  - \* Ferrit 25 MHz, 141 ohm

### 3.5 Control functions (std.) and with expansion card

The product is supplied from the factory with control functions according to "Basic functions" below.

Supplementing with the expansion card accessory (A3) adds solar control and its variants as well as bore hole recharging and various tanks. In addition, DHW circulation and pool control are also included.

#### Basic functions

(built into the factory version)

- Heating circuit 1
- Heating circuit 2\*
- Diff thermostat\*
- Passive cooling\*
- CTC SMS\*
- Remote control
- SmartGrid

#### Functions with expansion card (A3)

(accessory)

- Solar control
- DHW circulation
- Pool

\* Requires accessories such as: Extra sensor, mixing valve group 2, etc.

# Checklist

## The checklist must always be completed by the installation engineer

- If a service is performed, you may be required to provide this document.
- Installation must always be done according to the installation and maintenance instructions.
- Installation must always be carried out in a professional manner.
- Following installation, the unit must be inspected, functional checks performed and the customer informed.

## The points below must be checked off:

### Pipe installation

- CTC EcoZenith i255 filled, positioned and adjusted in the correct manner according to the instructions.
- CTC EcoZenith i255 Product positioned so that it can be serviced.
- Capacity of circulation pump(s) for required flow.
- Open radiator valves and other relevant valves.
- Tightness test.
- Bleeding and pressurising the system.
- Safety valve function test.
- Waste pipe connected to floor drain.

### Electrical installation

- Power switch.
- Correct and taut wiring.
- Primary flow sensor, return sensor + any required sensors for selected system.
- Outdoor sensor.
- Room sensor (optional).
- Accessories.
- Heat pump activated and started.
- Electric power and fuse, adapted for the property, in normal operation and backup mode.

### Customer information (adapted to the relevant installation)

- Start-up with customer/installer.
- Menus/controls for selected system.
- Installation and Maintenance Manual handed over to the customer.
- Check and filling, heating circuit.
- Fine-tuning information, heat curve.
- Alarm information.
- Mixing valve.
- Safety valve function test.
- Review warranty terms and conditions with the customer.
- Register your Installation Certificate at [ctc-heating.com](http://ctc-heating.com).
- Information on fault reporting procedures.

---

Date/Customer

---

Date/Installer

## 4. Your home's heating installation

### The House Heating Curve

The heating curve is the central part of the product's control system. It is the heating curve which determines the compensated flow temperature requirements for your property dependent upon the outdoor temperatures. It is important that the heating curve is correctly adjusted, so that you achieve the best operation and economy possible.

One property requires a radiator temperature of 30 °C when the outdoor temperature is 0 °C, whilst a different property requires 40 °C. The difference between different properties is determined by the radiator surface area, the number of radiators and how well insulated the house is.

### Adjusting the heating curve

In the "Heating curve" menu under "Settings/Heating circuit", you can fine adjust the values of the heating curve for the primary flow temperature in relation to the outdoor temperature in the graph, as well as set the values for curve inclination and curve adjustment for the heating circuit.

**See section "Heating curve" in chapter "Settings/ Heating circuit" for detailed information.**

Ask your installer to help you set these values.

It is extremely important to set the heating curve and, in some cases, unfortunately, this process may take several weeks. The best way of doing this, upon the initial start-up, is to select operation without any room sensor. The system then operates using the outdoor temperature reading and the property's heating curve only.

**During the adjustment period it is important that:**

- the night reduction function is not selected.
- all thermostat valves on the radiators be fully opened. (This is to find the lowest curve for the most economical use of the heat pump).
- the outdoor temperature is not higher than +5 °C.
- the radiator system is operational and correctly adjusted between different circuits.

**i** For more information on how to set the heating curve, see section "Heating curve" in chapter "Settings / Heating circuit".

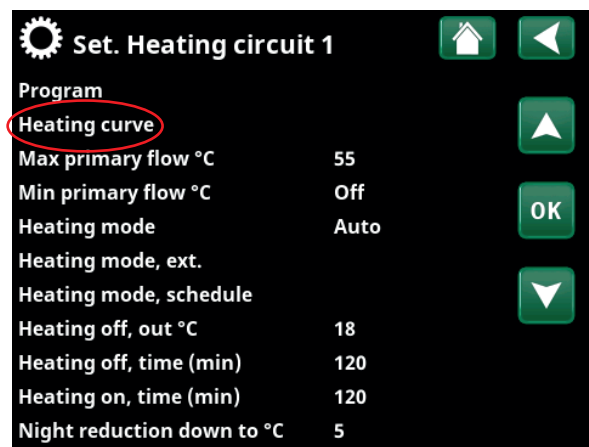

Part of the "Installer/Settings/Heating Circuit/Heating Circuit 1" menu.

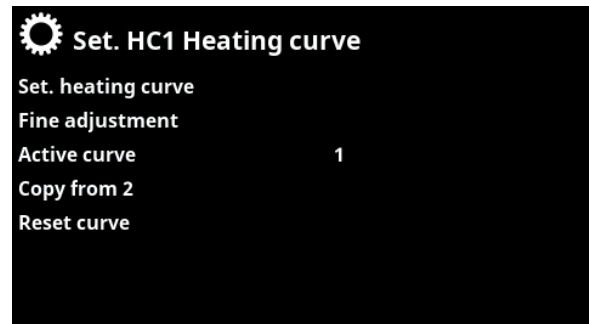

Menu: "Installer / Settings / Heating Circuit / Heating Circuit 1/Heating curve". Active curve: #1.

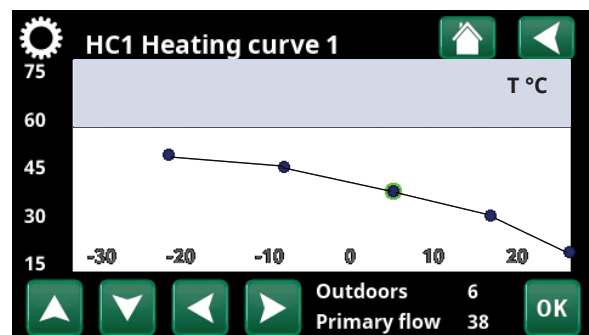

Menu: "Installer / Settings / Heating Circuit / Heating Circuit 1/Heating curve/Fine adjustment".

## Appropriate Default Values

During installation you can seldom achieve a precise setting for the heating curve instantly. In this case, the values given below may provide a good starting point. Radiators with small heat-emission surfaces require a higher primary flow temperature. You can adjust the gradient (heating curve gradient) for your heating system under the "Installer / Settings / Radiator system" menu. Recommended values are:

Floor heating only:	Inclination 35
Low temperature system: (well insulated houses)	Inclination 40
Normal temperature system: (factory setting)	Inclination 50
High temperature system: (older houses, small radiators, poorly insulated)	Inclination 60

## Adjusting the heating curve

The method described below can be used to adjust the heating curve correctly.

### Adjustment if it is too cold indoors:

- If the outdoor temperature is **lower** than 0 degrees:  
Increase the Inclination value by a couple of degrees.  
Wait 24 hours to see if any further adjustment is required.
- If the outdoor temperature is **higher** than 0 degrees:  
Increase the Adjustment value by a couple of degrees. Wait 24 hours to see if any further adjustment is required.

### Adjustment if it is too warm indoors:

- If the outdoor temperature is **lower** than 0 degrees:  
Decrease the Inclination value by a couple of degrees.  
Wait 24 hours to see if any further adjustment is required.
- If the outdoor temperature is **higher** than 0 degrees:  
Decrease the Adjustment value by a couple of degrees.  
Wait 24 hours to see if any further adjustment is required.



The set heating curve always takes priority. The room sensor can only increase or decrease the heat beyond the set heating curve to a certain extent. Where operating without a room sensor, the selected heating curve determines the flow temperature supplied to the radiators.



## Examples of Heating Curves

You can see in the diagram below how the heating curve changes with different Inclination settings. The gradient of the curve shows the temperatures that the radiators require at different outdoor temperatures.

### Curve Inclination

The inclination value which is set is the primary flow temperature when the outside temperature is  $-15^{\circ}\text{C}$ .

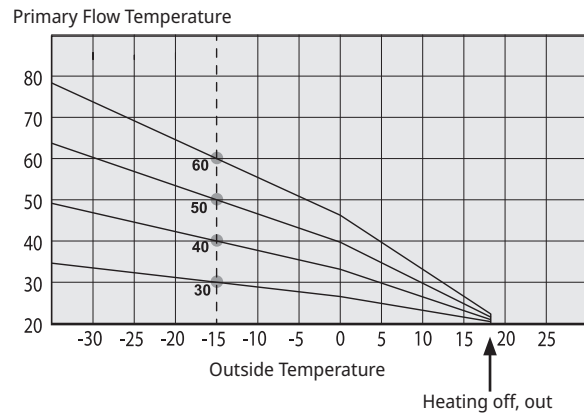

### Adjustment

The curve can be parallel displaced (adjusted) by the desired number of degrees to adapt to different systems/houses.

Inclination  $50^{\circ}\text{C}$   
Adjustment  $+5^{\circ}\text{C}$

Inclination  $50^{\circ}\text{C}$   
Adjustment  $0^{\circ}\text{C}$

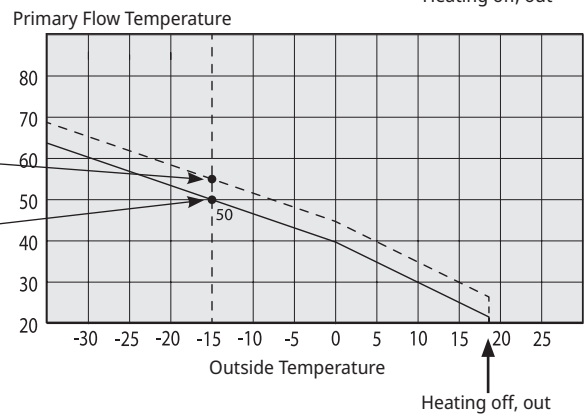

### An example

Inclination  $60^{\circ}\text{C}$   
Adjustment  $0^{\circ}\text{C}$

In this example, the maximum outgoing primary flow temperature is set at  $55^{\circ}\text{C}$ . The minimum permitted primary flow temperature is  $27^{\circ}\text{C}$  (e.g. summer-time basement heating or the floor circuits in a bathroom).

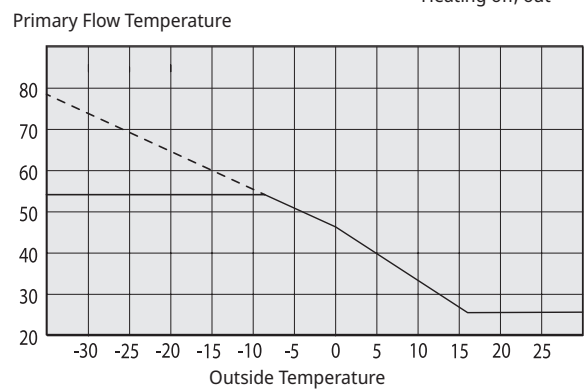

If the values set are too low, this may mean that the desired room temperature is not being reached. You then need to adjust the heating curve, as necessary, following the method shown above.

### Summer season

All properties have internal heat gains (lamps, oven, body heat, etc.), which means that the heating can be switched off when the outdoor temperature is lower than the desired room temperature. The better insulated the house is, the earlier the heating from the heat pump can be switched off.

The example shows the product set at the default value of 18°C. This value, "**Heating off, outside**", can be changed in the "Installer/Settings/Heat circuit" menu.

In systems with a radiator pump, the radiator pump stops when the heat is switched off. The heating starts up automatically when it is required again.

See chapter "Settings/Heating circuit" for information on setting the heating mode.

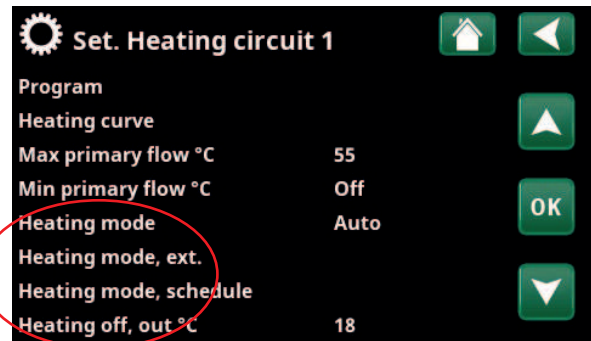
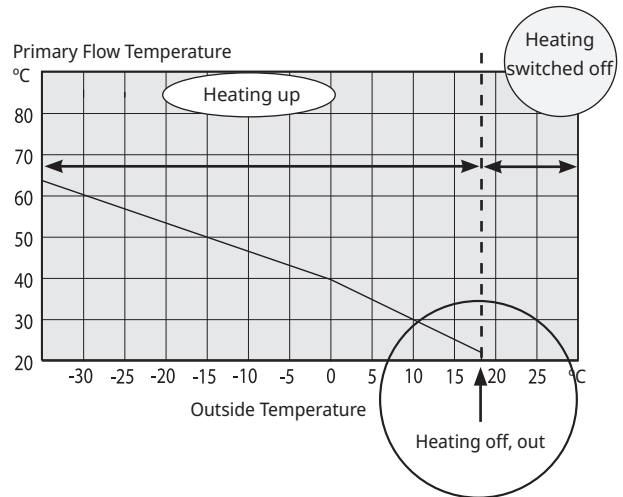

Part of the "Installer/Settings/Heating Circuit/Heating Circuit 1" menu.

## 5. Technical data

### 5.1 Table 400V 3N~

Electrical Data		CTC EcoZenith i255 H	CTC EcoZenith i255 L
Electrical data		400V 3N~ 50Hz	
Rated power (switching)	kW	15 (18)	
Group fuse	A	15 kW: 25 (18 kW: 32)	
Immersion heater, upper (adjustable, steps of 0.3 kW)	kW	0.3-9.0	
Immersion heater, lower (switching)	kW	6 (3/6/9)	
Max power immersion heater at group fuse (upper+lower) 10/13/16/20/25 A	kW	15 kW: 2.1+0/0.9+6/9+0/6.9+6/9+6 18 kW: 2.1+0/0.9+6/9+0/2.1+9/6.9+9	
IP class		IP X1	

Heating system		CTC EcoZenith i255 H	CTC EcoZenith i255 L
Water volume (V)	l	223	
Max. Operating pressure (PS)	bar	3.0	
Max. Temperature (TS)	°C	100	
Pressure drop for Mixing valve heating		See Pressure drop diagram in the "Pipe installation" chapter.	

Hot water system		CTC EcoZenith i255 H	CTC EcoZenith i255 L
Water volume (V)	l	5.7 Cu (8.5 Inox)	
Max. Operating pressure (PS)	bar	10	

Other data			
Weight			
Depth x Width x Height	mm	673 x 596 x 1904	673 x 596 x 1649
Required ceiling height			

## 5.2 Table 230V 1N~/230V 3~

<b>Electrical Data</b>		<b>CTC EcoZenith i255 L 1 x 230V</b>	<b>CTC EcoZenith i255 L 3 x 230V</b>
Electrical data		230V 1N~ 50Hz	230V 3~ 50Hz
Rated power	kW	12	14
Group fuse	A	63	50
Immersion heater, upper (adjustable)	kW	2 - 9 (0/2/3/4/5/6/7/9)	1.2 - 7.05 (0/1.2/2.4/3.5/4.6/5.8/7.05)
Immersion heater, lower (adjustable)	kW	1 - 3 (0/3.0)	1.2 - 7.05 (0/7.05)
Max power immersion heater at group fuse (upper+lower) 20/25/32/35/50/63 A	kW	4/5/7/7/11/12	7/8.2/11.7/12.9 /14/14
IP class		IP X1	

<b>Heating system</b>		<b>CTC EcoZenith i255 L 1 x 230V</b>	<b>CTC EcoZenith i255 L 3 x 230V</b>
Water volume (V)	l	223	
Max. Operating pressure (PS)	bar	3.0	
Max. Temperature (TS)	°C	100	
Pressure drop for Mixing valve heating		See Pressure drop diagram in the "Pipe installation" chapter.	

<b>Hot water system</b>		<b>CTC EcoZenith i255 L 1 x 230V</b>	<b>CTC EcoZenith i255 L 3 x 230V</b>
Water volume (V)	l	5.7 Cu (8.5 Inox)	
Max. Operating pressure (PS)	bar	10	

<b>Other data</b>		<b>CTC EcoZenith i255 L 1 x 230V</b>	<b>CTC EcoZenith i255 L 3 x 230V</b>
Weight	kg	167	
Depth x Width x Height	mm	673 x 596 x 1649	
Required ceiling height	mm	1628	

### 5.3 Measurements

Low Model - CTC EcoZenit i255L

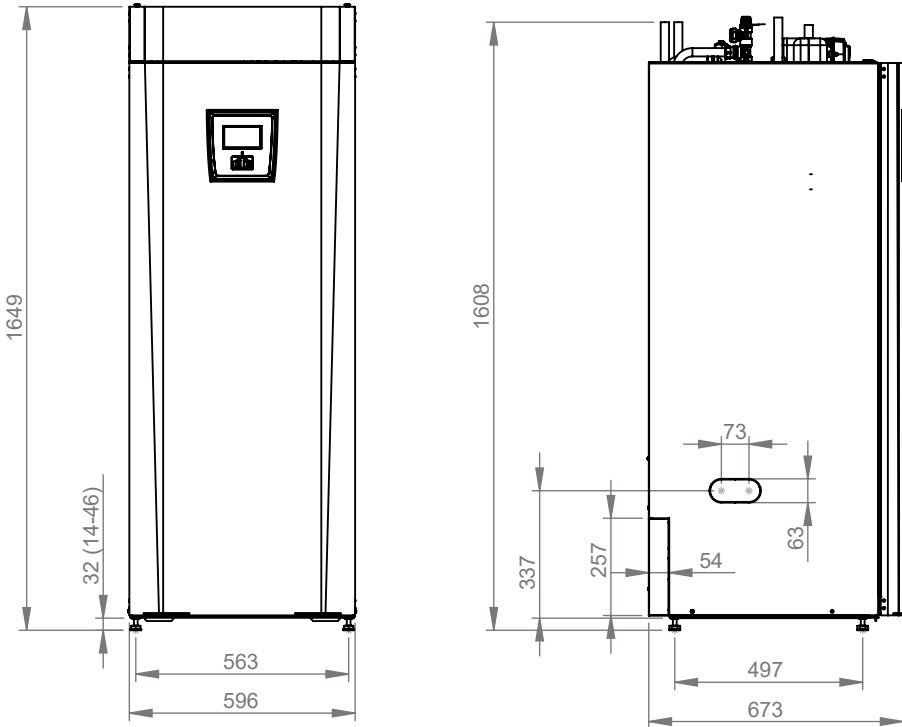

High Model - CTC EcoZenit i255H

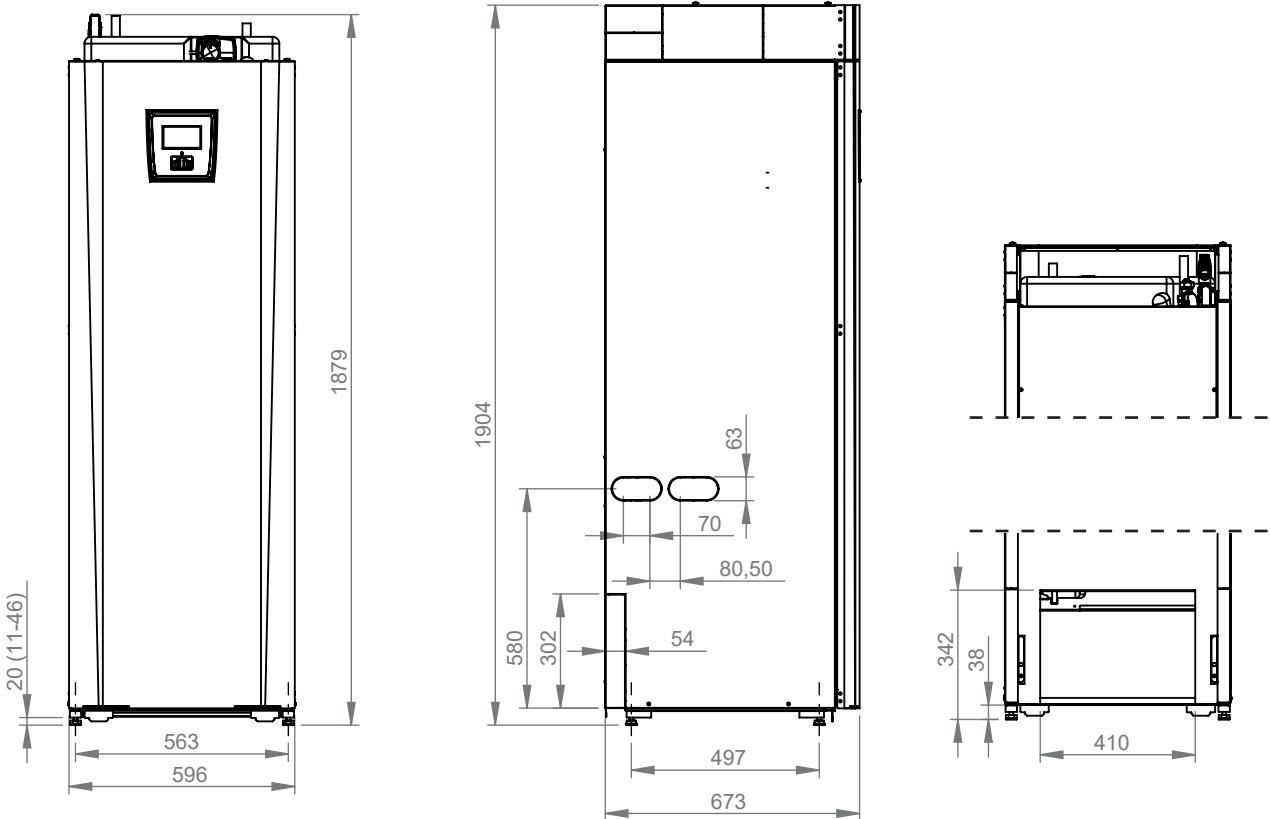





## 6. Function description

The picture below shows the basic construction of CTC EcoZenith i255.

If a heat pump is connected, the energy in the air or bedrock/ground is drawn up by the cooling system. The compressor then increases the temperature to a usable level. Afterwards it releases the energy for the heating circuit and DHW. The built-in immersion heaters help when additional heat is needed or when a heat pump is not connected.

### Fresh water connections

Here you connect the property's fresh water connections. The cold water is led down and heated in the lower part of the coiling.

### Upper part

In the upper part of the coil, hot water is reheated to the desired temperature.

### Upper immersion heater

Built-in upper immersion heater. When connected to the heat pump, the immersion heater acts as additional heat.

### Lower immersion heater

Built-in lower immersion heater. Not used in normal operation when the heat pump is connected.

### Heat medium pump

The adjustable-speed charge pump transports the cold water from the boiler to the heat pump where the energy from the air or bedrock/ground is drawn up and taken back to the boiler.

The boiler is supplied with a circulation pump for a heat pump of up to 12 kW!

### Connection for drainage

### Heat pump pipe

CTC EcoZenith i255 L is equipped with connection pipes for top connection.

### Bivalent mixing valve

The automated mixing valve ensures that an even heat is continuously supplied to the heating circuit.

### DHW finned coil

CTC EcoZenith i255 is equipped with a well-dimensioned finned coil made of copper. Since DHW is not stored, there is no risk of legionella bacteria.

### Lower part

In the lower part of the coil the DHW is pre-heated by the water heated by the heat pump. The larger section of the coil is in this part.

### Expansion connection

15 mm.

### Flow conditioner

The heated water from the heat pump alternately heats up the upper or lower part of the tank.

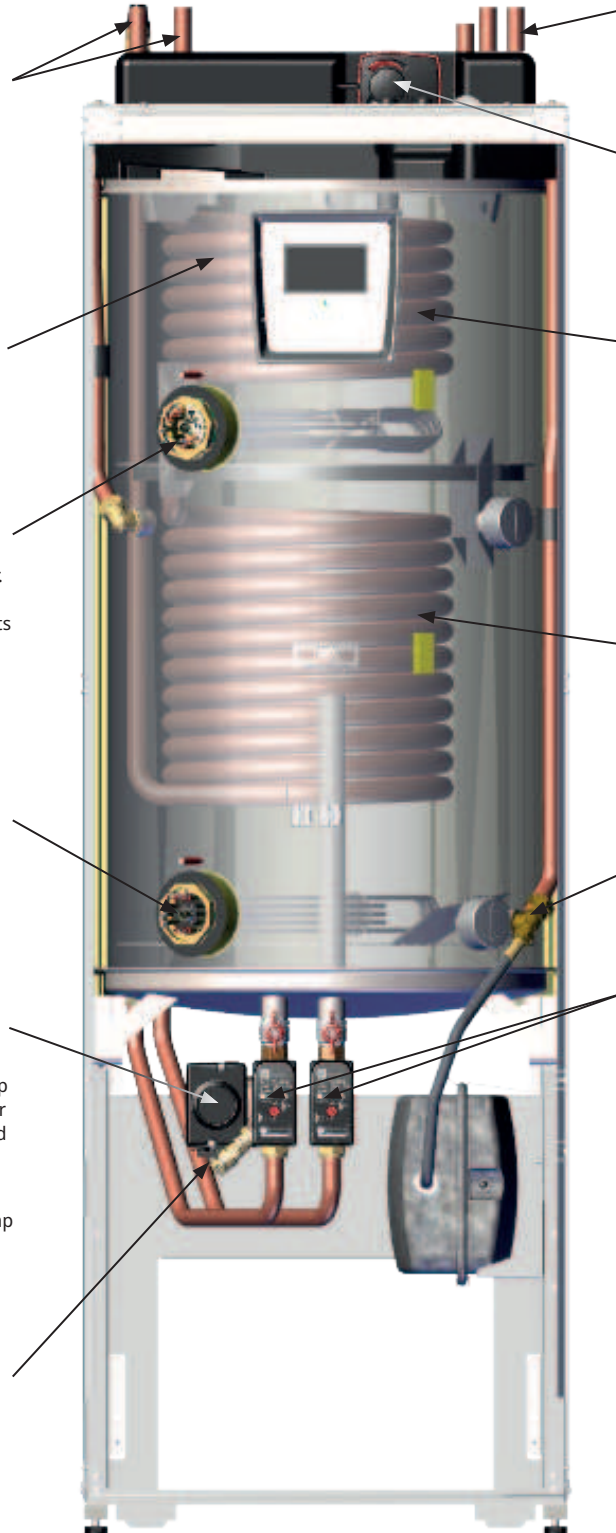

## 7. Parameter list EcoZenith i255

The tables show factory settings for important product parameters.

Heating circuit	Factory setting
Program Economy	-
Room temp change °C	-2.0
Off delay, min	No
SmartGrid Blocking	Off
Program Comfort	-
Room temp change °C	2.0
Off delay, min	No
SmartGrid Low price	Off
SmartGrid Overcapacity	Off
Program Custom	-
Room temp change °C	0.0
Off delay, min	No
SmartGrid Blocking	Off
SmartGrid Low price	Off
SmartGrid Overcapacity	Off
Max primary flow °C	55
Min primary flow °C	Off
Heating mode	Auto
Heating mode, ext.	-
Heating off, out °C	18
Heating off, time (min)	120
Night reduction down to °C	5
Room temp. reduced, Night red. °C (Prim flow.)	-2 -3
Room temp. reduced, Holiday °C (Prim flow)	-2 -3
Alarm room temp °C	5
SmartGrid Low price °C	Off
SmartGrid Overcapacity °C	Off
SmartGrid Blocking	Off
Anti Water Hammer	No
HP max DHW	No
Drying period mode	Off
Drying period temp °C	25

Heat pump	Factory setting
Compressor	Permitted
Stop at outdoor temp °C	-22
Tariff HP	No
Tariff HP schedule	
Minimum run time (min)	6
SmartGrid Block. HP	No
Max RPS	90
Max RPS warm temp	50
Ext. noise reduction RPS	0
Noise reduction schedule	
Charge pump %	50
Auto adj. charge pump	
Cold temp limit	0
Warm temp limit	20
Silent mode, schedule	
Defrost heating temp min m	10
Defrost heating temp max m	10
Defrost heating temp min °C	10
Defrost heating temp max °C	-10

Immersion heater	Factory setting
Boiler upper add. °C	57
Boiler upper extra DHW °C	60
Boiler upper max kW	5.5
Boiler lower °C	50
Boiler lower kW	6.0
Delay mixing valve	180
Main fuse A	20
Conv. factor curr. sensors	1
Tariff EL	No
SmartGrid block immersion	No
SmartGrid block mixing valve	No

Upper tank	Factory setting
Program Economy	-
Stop temp HP °C	50
Boiler upper °C	40
Program Normal	-
Stop temp HP °C	60
Boiler upper °C	40
Program Comfort	-
Stop temp HP °C	60
Boiler upper °C	50
Start/stop diff. upper °C	7
Max time upper tank (min)	30
Max time lower tank (min)	20
SmartGrid Blocking °C	Off
SmartGrid Low price °C	Off
SmartGrid Overcapacity °C	Off
SmartGrid Overcapacity block HP	No
Time ExtraDHW Remote Control (min)	0.0

Lower tank	Factory setting
SmartGrid Low price °C	Off
SmartGrid Overcapacity °C	Off

Diff thermostat	Factory setting
Charge start diff temp °C	7
Charge stop diff temp °C	3
Charge temperature °C	60
Charge tank	No

Cooling	Factory setting
Room temp. cooling °C	25
SmartGrid Low price °C	Off
SmartGrid Overcapacity °C	Off
Ext. block cooling	No

## 8. Control system

The CTC EcoZenith i255 has an advanced yet straightforward control system with a touchscreen on which all settings are entered directly.

### The CTC EcoZenith i255 control system:

- monitors all functions in the system tank, heat pump and heating system.
- allows for individual settings.
- Displays desired values, such as temperatures, operation times, energy consumption and fault signals.
- Allows for simple and structured value setting and troubleshooting.

### Factory values

CTC EcoZenith i255 is delivered with set factory values which are suitable for a normal house with a normal heating circuit. The CTC EcoZenith i255 automatically adjusts the water temperature to the primary flow's current heating requirement. This is monitored by the control system, which continuously ensures that you are provided with optimum function and economy. These values are easy to change as and when required. Ask your installer to help you determine the correct values.

### Heat pump

On delivery the CTC EcoZenith i255 is ready for connection to a CTC heat pump –

This means that the control system already contains all the controls for the heat pump. When the heat pump has been defined (On), CTC EcoZenith i255 senses which heat pump has been connected. "Installer/Define/Heat Pump".

Once this has taken place the menus for the heat pump are displayed. On delivery the compressor is blocked and must be enabled. This is done in the "Installer/Settings /Heat Pump" menu.

### CTC EcoVent

The product is ready for connection with the CTC EcoVent ventilation product.

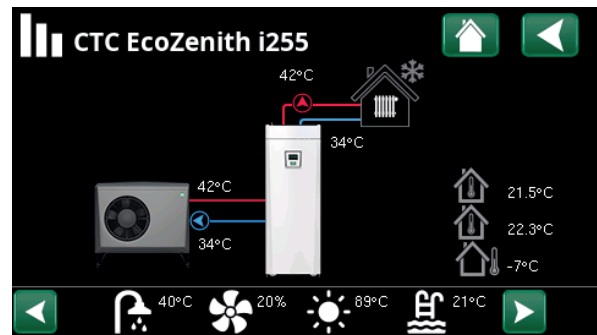
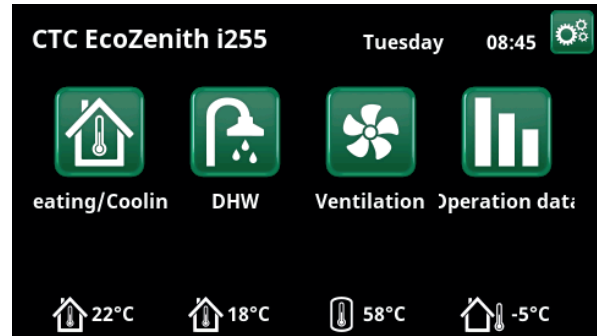



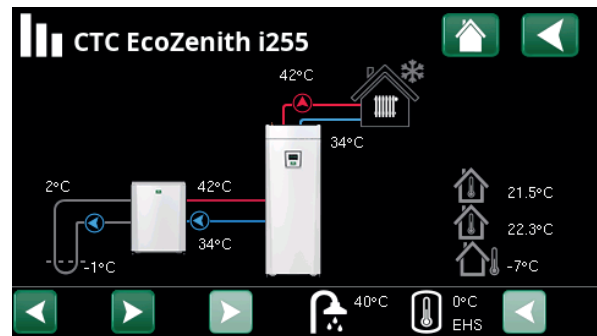



The screen shows operating information with the CTC EcoAir heat pump connected.



The screen shows operating information with the CTC EcoPart heat pump connected.

## 8.1 Quick start touchscreen

The illustration below shows the most common functions you need to set and use as the end customer.

	<b>Scroll &amp; Swipe</b>	 Start menu	 increase value
	<b>Single click = Select</b>	 Back	 Select and save
	<b>Double click = Open</b>	 decrease value	 increase value



### Start menu

**Room temperature Heating Circuit 1**  
Measured by Room Sensor 1

**Room temperature Heating Circuit 2**  
Measured by Room Sensor 2

**Tank temperature**  
Measured by DHW Sensor in upper tank.

**Outdoor temperature**  
Measured by Outdoor Sensor.

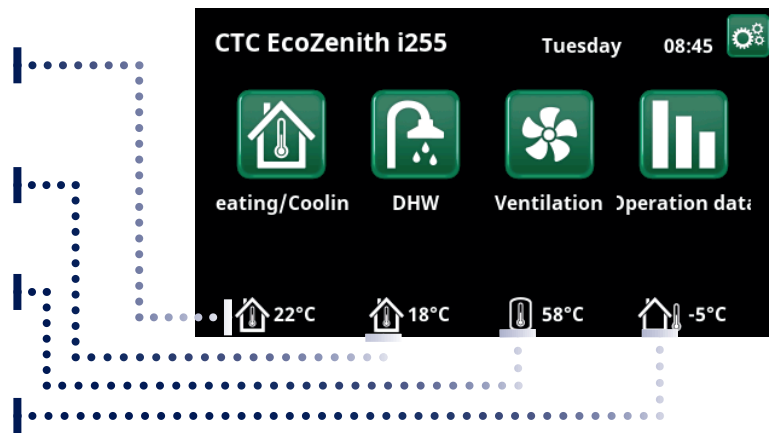

### Heating/Cooling

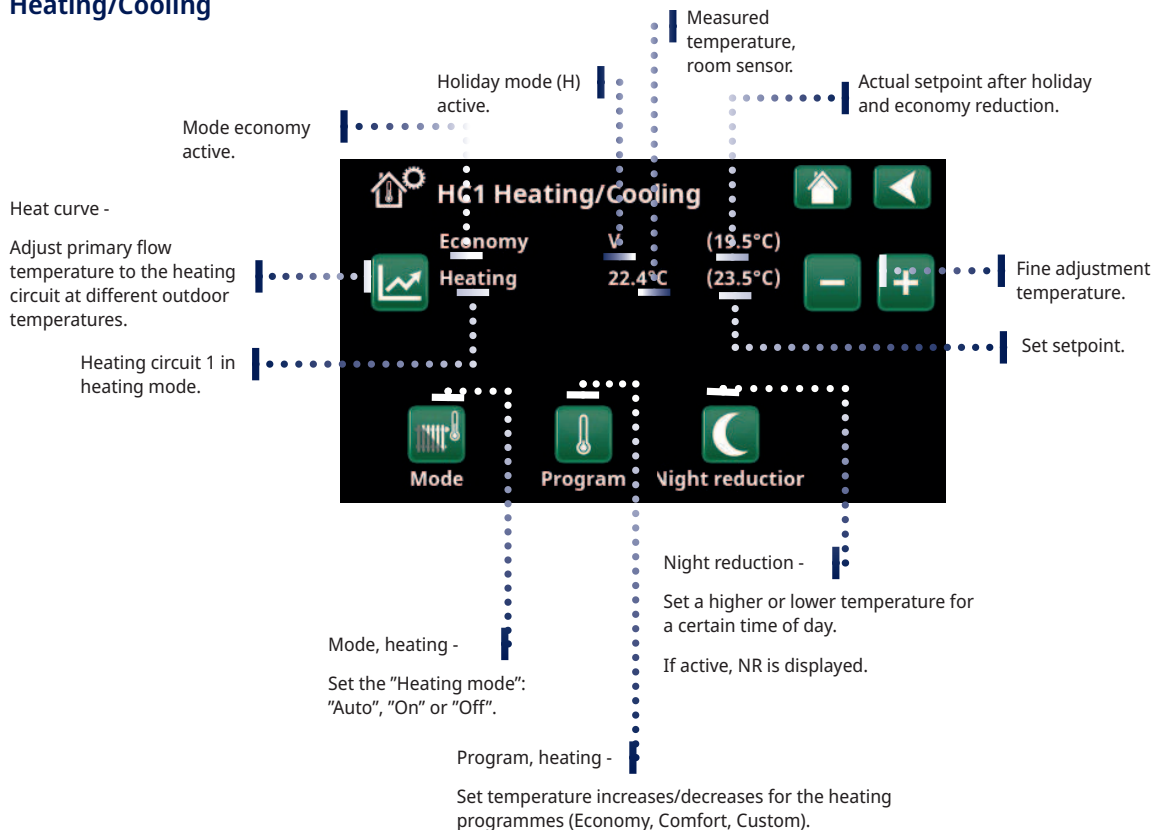



## DHW

### Schedule "Extra DHW"

Tip: Set the time approx. 1 hour earlier than when you need the hot water as it may take some time to heat.

### Start Extra DHW Timer

### Select DHW program

Economy – Small DHW requirement

Normal – Normal DHW requirement

Comfort – Large DHW requirement

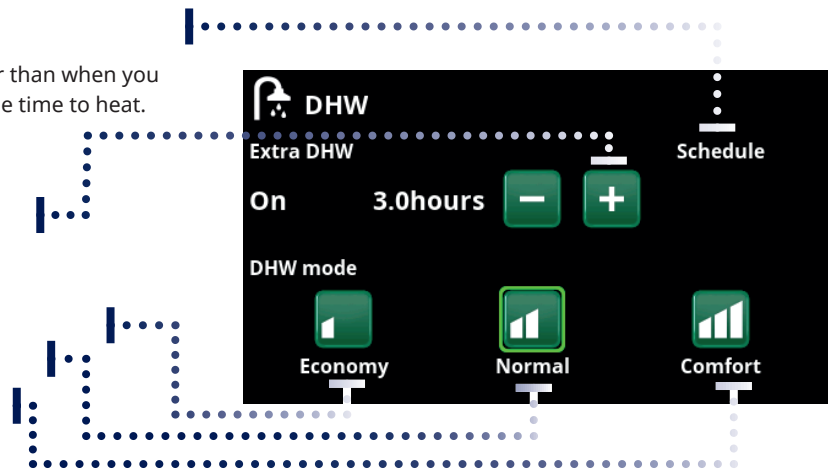

## Ventilation

Refer to the manual for the EcoVent accessory.

The symbol is only displayed on the home screen if EcoVent is defined.



## Operating information

- Heating circuit
- Control and tank
- Heat pump
- Functions

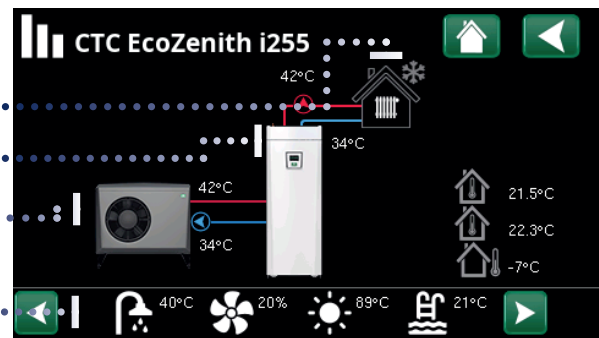

Main menu page for operation data of the defined system.

### Click the images for detailed operation data about the respective part

For detailed operation data, a gear symbol is shown alongside the icon in the top left. The icon is a shortcut to settings for the respective part.

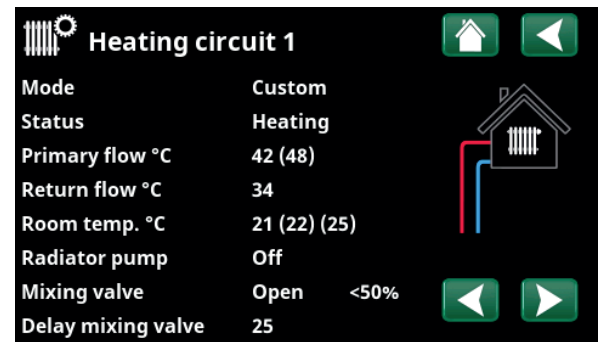

The menu shows detailed operation data of the selected heating circuit. Click the arrows or swipe to view defined heating circuits.



Shortcut to the "Installer/Settings/Heating Circuit 1" menu.



## Installer

Settings and service, refer to detailed descriptions in the next chapter.



## 8.2 Installation wizard

When starting up the system and during reinstallation (refer to the "Installer /Service" chapter), a number of system options must be selected. The dialogue boxes which will then be displayed are described below. The values shown in the menu screenshots below are only examples.

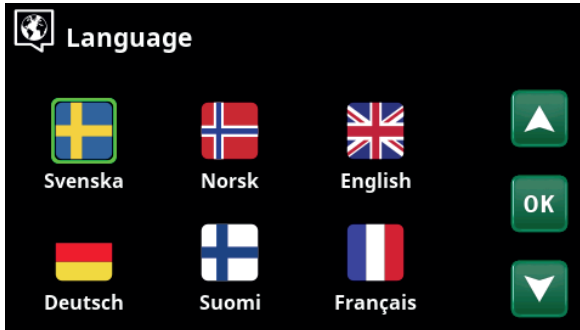

1. Choose language. Press OK to confirm.



2. Select the country where the heat pump is installed. Press OK to confirm.

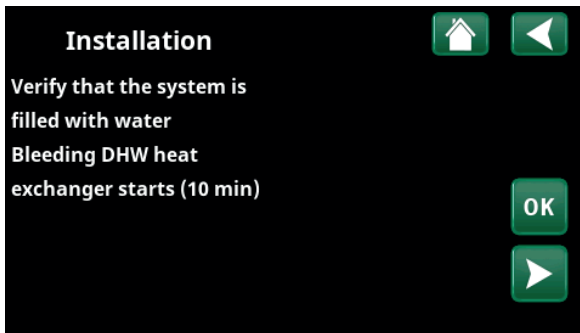

3. Verify that the system is filled with water. Confirm with "OK" and the "right" directional arrow.



4. Select the size of the main fuse using the "+" and "-" buttons. Confirm with the "right" directional arrow. For more information about settings, refer to the "Installer/Settings/Electric Heater" chapter.

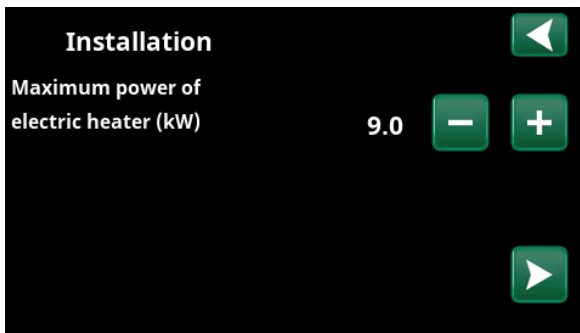

5. Select maximum electric heater power using the "+" and "-" buttons. Confirm with the "right" directional arrow. For more information about settings, refer to the "Installer/Settings/Electric Heater" chapter.

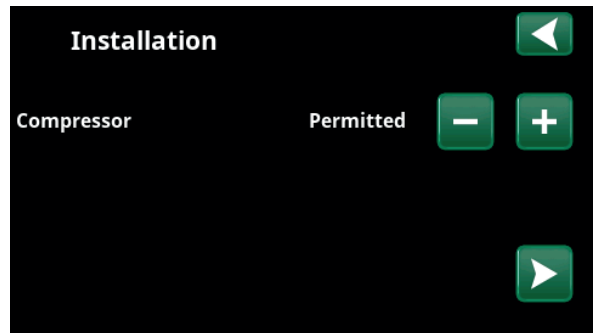

6. Specify whether the compressor is "Permitted" or "Blocked" using the "+" and "-" buttons. Confirm with the "right" directional arrow.

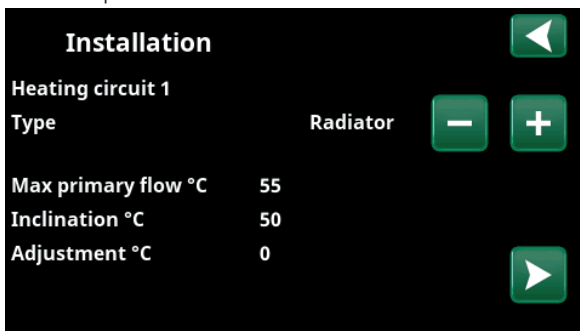

7. Specify whether heating circuit 1 applies to radiators or underfloor heating. Switch between "Radiator" and "Underfloor Heating" using the "+" and "-" buttons. Confirm with the "right" directional arrow.

8. If Heating circuit 2 is defined, the corresponding menu for this system is displayed. Make a corresponding selection ("Radiator" and "Underfloor Heating") for Heating circuit 2 and finish the wizard with "OK".

## 9. Detailed menu descriptions

All settings can be configured directly on-screen using the easy-to-read control panel. Operational and temperature information is also displayed here. You can easily enter the different menus to find information on the operation or to set your own values. For information about start-up and re-installation, refer to the "First Start" chapter at the back of this manual.

### 9.1 Start menu

This menu is the system's home screen. This provides an overview of the current operation data. The system returns to this menu if no buttons are pressed within 10 minutes. All other menus can be accessed from this menu. NB: Some menus are only shown if a heat pump is installed.

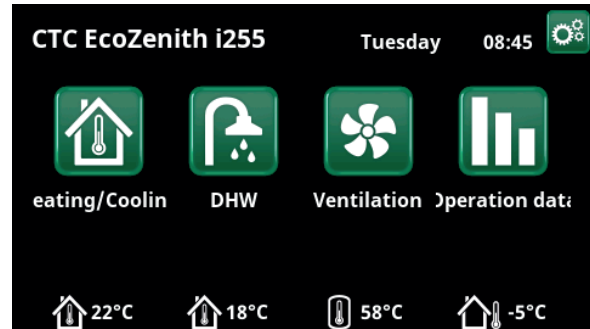

### 9.2 Alarm management

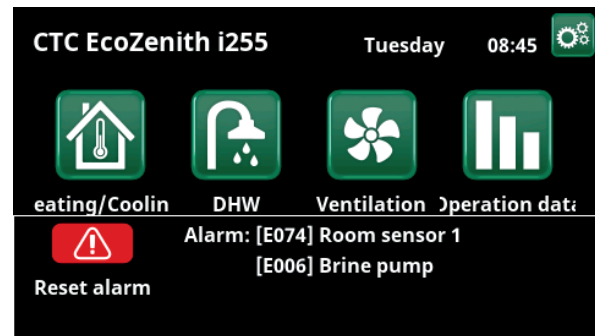
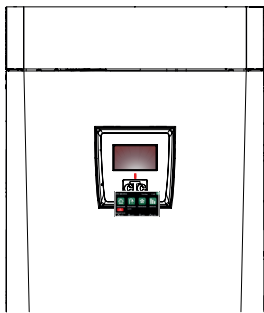

Signal	Status
Green LED	OK
Red/yellow flashing LED	Alarm
Green flashing LED	Operation with active immersion heater - Applies only with language selection "Danish".
Info message at bottom	Information message about the current status.



See troubleshooting chart at the very back of the installation manual.



Call your installation engineer in the first instance.

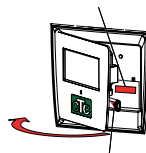

The serial number (12 digits) can be found behind the display. This number is needed to be given to the installation engineer and CTC support in the event of a fault report.



## 9.3 Heating/Cooling

In the menu "HC- Heating/Cooling" the following settings can be made:

### 9.3.1 Setpoint setting with room sensor

Set the desired room temperature (set point) with the "minus" and "plus" buttons. In the example in the "HC1 Heating/Cooling" menu, the "Economy" programme and "Holiday mode" (V) are active for heating circuit 1.

In the "HC2 Heating/Cooling" menu, the "Cooling" mode is active.

"Holiday mode" and "Night reduction" only lower the room temperature when heating mode is active.

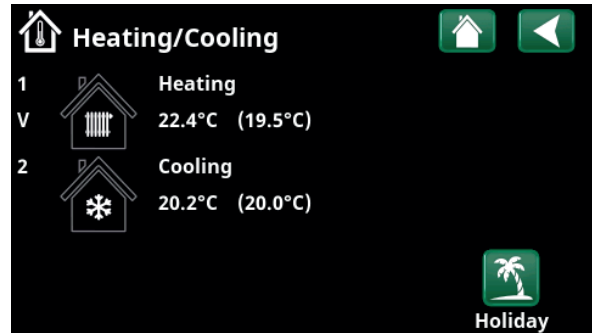

Click on heating circuit 1 or 2 to go to the menu of the respective heating circuit. In this menu you can activate "Holiday mode" for the heating circuits.

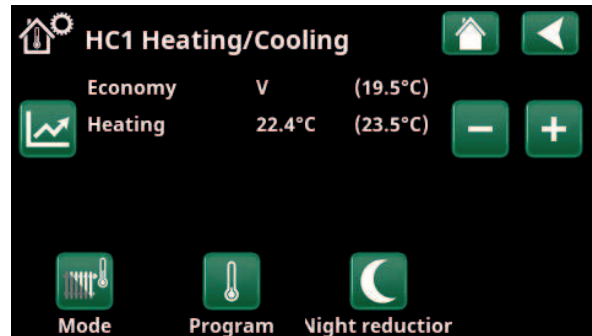

In the menu, programs "Economy" and "Holiday mode" (V) are active for heating circuit 1. In this example, both the "Economy" and "Holiday Mode" programmes are set to lower the set point (23.5 °C) by 2 °C, which means that the actual set point = 23.5 - 2 - 2 °C = 19.5 °C.

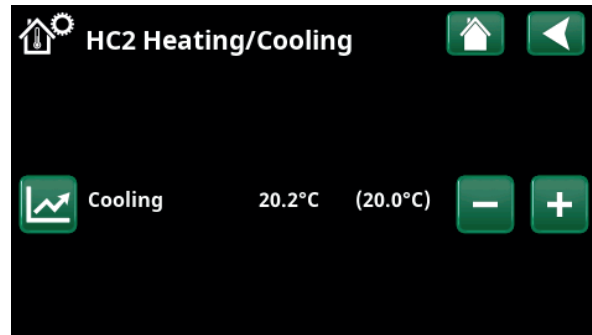

In the menu, "Cooling" (setpoint: 20.0 °C) is active for heating circuit 2. "Holiday mode" (V) does not lower the setpoint when cooling is active.



### 9.3.2 Program

Press the "Program" button and the heating program to be activated (Economy, Normal, Comfort or Custom). It is also possible to schedule the programmes.

See chapter "Installer/Settings/Heating circuit/Program" for information on how to set temperature increases/ decreases and delay times for the programmes.

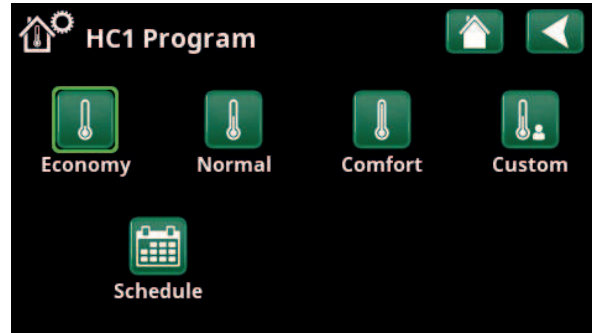

Menu "HC1 Heating/Cooling / HC1 Program" where program "Economy" has been activated.



### 9.3.3 Heating curve

Press the heating curve symbol in the "HC1- Heating/ Cooling" menu. The graph of the heating circuit heat curve is displayed.

The chapter "Installer/Installation/Heating circuit" describes the setting of the heating curve.

See also chapter "House heating curve" for more information on adjusting the heating curve.

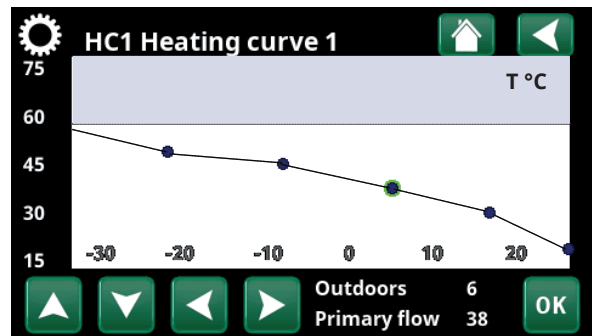

Menu "Heating/Cooling/HC1 Heating/Cooling".



### 9.3.4 Heating mode

Press the "Mode" button and then select " Heating mode"; "Auto", "On" or "Off".

Heating mode can also be selected in the menu "Installer/Settings/Heating circuit/Heating mode".

See chapter "Installer/Settings/Heating circuit" for more information.

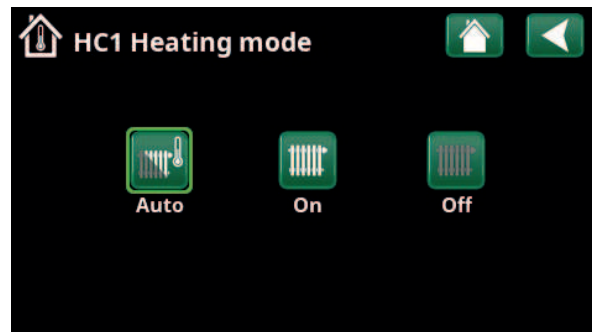

Menu "HC1 Heating/Cooling/HC1 Heating mode" where mode "Auto" has been activated.

### 9.3.5 Room temperature setting without room sensor

You can select "Room sensor - No" in the "Installer/Define/Heating circuit" menu. This is used if the room sensor is difficult to place, if the underfloor heating system control has its own room sensor or if you are using a wood-burning stove/fireplace. The alarm LED on the room sensor works as usual.

If a wood-burning stove or fireplace is used sporadically, the burning may cause the room sensor to reduce the temperature of the heating circuit and it may become cold in the rooms in other parts of the house. The room sensor can then be temporarily switched off during firing and the heat pump provides heat to the heating circuit according to the set heating curve. The radiator thermostats are throttled in the part of the house where the fire is burning.

If the room sensor has not been installed, the heating must be set according to the chapter "House heating setting".

### 9.3.6 Outdoor sensor/room sensor errors

If a fault occurs with an outdoor sensor, the product triggers an alarm and an outdoor temperature of -5 °C is simulated so that the house does not get cold.

If a fault occurs with a room sensor, the product triggers an alarm and automatically switches to operating according to the set curve.

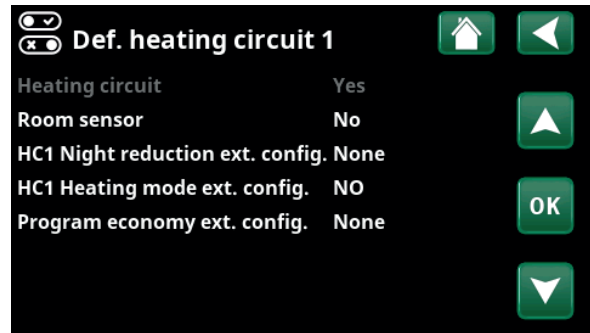

Menu "Installer/Define/Heating circuit/Heating circuit 1".

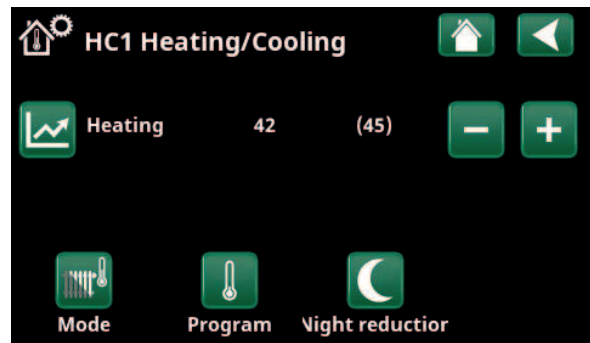

Menu "Installer/Define/Heating circuit/Heating circuit 1". The heating circuit has no room sensors. The setpoint (primary flow temperature 45 °C) is shown in brackets, the current primary flow temperature 42 °C is shown to the left of the setpoint.



### 9.3.7 Night Reduction Temperature

Night reduction means reducing the temperature indoors, via remote control or during scheduled periods.

In the menu "HC1 Night reduction" menu, the periods during the week for night temperature reduction can be scheduled.

The "Night reduction" icon in the "Heating/Cooling" menu only appears if a "Schedule" has been defined for the heating circuit in the "Installer/Define/Remote control" menu.

The "Schedule" chapter describes how to set schedules.

The value by which the temperature is reduced during remote control of the night reduction is set in one of the following menus.

**Room sensor installed:**

"Installer/Settings/Heating circuit/Room temp reduced night red °C".

**Room sensor not installed:**

"Installer/Settings/Heating circuit/Prim. flow reduced night red °C".

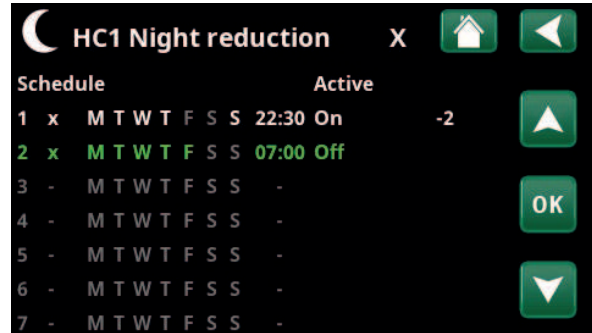

The schedule has been set for "Night Reduction" to be active weekdays between 22:30 and 07:00, except during the night between Friday and Saturday and the night between Saturday and Sunday (when no night reduction occurs).

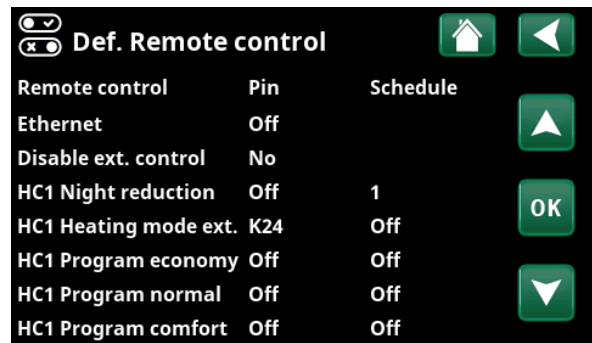

Menu: "Installer/Define/Remote Control".  
The "HC1 Night Reduction" function is assigned to Schedule #1.



### 9.3.8 Holiday

This option is used to set the number of days that you want continuous reduction of inside temperature, for example if you want to go on holiday.

The value by which the temperature is reduced during the period is set in one of the following menus:.

**Room sensor installed:**

"Installer/Settings/Heating circuit/Room temp reduced holiday °C".

**Room sensor not installed:**

"Installer/Settings/Heating circuit/Prim. flow reduced holiday °C".

Holiday reduction is enabled from the time of setting (press the plus (+) sign).

Up to 300 days can be set.

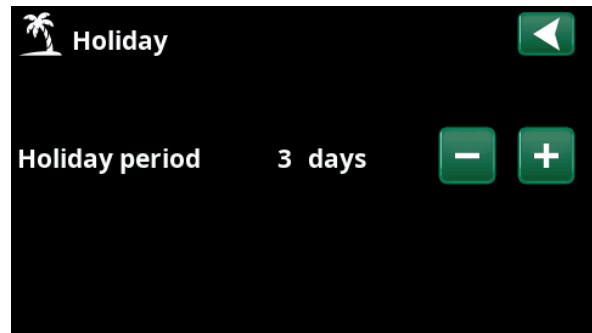

When holiday is enabled, hot water production is stopped. The "Temporary extra DHW" feature is also stopped.

When both "Night Reduction" and "Holiday Reduction" are in use, "Holiday Reduction" supersedes "Night Reduction".





## 9.4 DHW

This menu is used to set the hot water comfort level and "Extra DHW".

### Extra DHW

The "Extra DHW" function can be activated here. When the function is activated (by setting the number of hours using the plus sign in the "Hot Water" menu), the heat pump immediately starts to produce extra DHW. It is also possible to remotely control or schedule hot water production according to specified times.

### DHW mode

You set the values for this option which apply to the heat pump's normal operation. There are three modes:



#### Economy

For low hot water needs.  
(Factory value stop temperature DHW tank: 30 °C).



#### Normal

Normal hot water needs.  
(Factory value stop temperature DHW tank: 35 °C).



#### Comfort

For high hot water needs.  
(Factory value stop temperature DHW tank: 40 °C).

### 9.4.1 Extra DHW

You can use this menu to schedule periods during weekdays when you want extra DHW. This schedule is repeated every week.

The stop temperature for Extra DHW is 60 °C (factory setting).

The "Schedule" chapter describes how to set schedules.

Click the "Extra DHW" heading to obtain a graphical overview of when the schedule is active during weekdays.

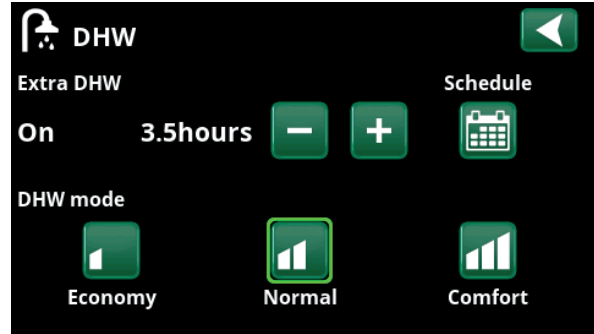

The "Extra DHW" function is set to be active for 3.5 hours.

**NB:** Set the time approx. 1 hour earlier than when you need the hot water as it may take some time to heat-up.

**Tip:** Set to "Economy" mode from the start. If the hot water is deemed insufficient, raise to "Normal" mode, and so on.

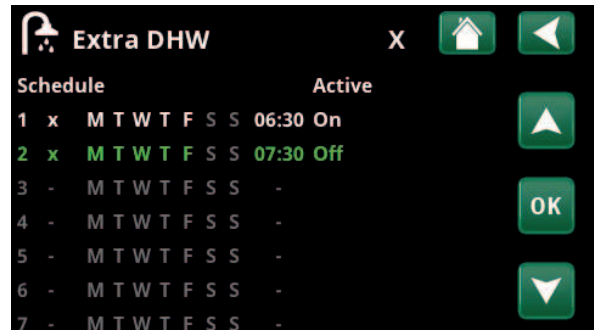

The "Extra DHW" function is set to be active on weekdays between 06:30 and 07:30.

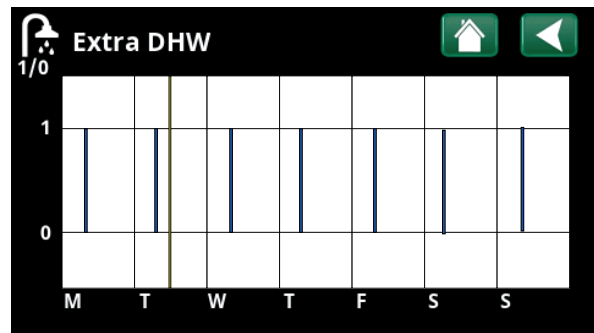

Use the Back button to switch between settings and preview. A vertical blue bar indicates when "Extra DHW" is active. A horizontal yellow line indicates the current time. The X axis represents the days, Monday to Sunday.



## 9.5 Ventilation

Refer to the "Installation and Maintenance Manual" for the CTC EcoVent ventilation product.

## 9.6 Schedule

In a Schedule, the periods can be set for when a function should be active or inactive during the weekdays.

The system does not allow certain functions to be active at the same time on the same schedule; for example, the "Night Reduction" and "Extra DHW" functions, but most functions can share the same schedule.

If several functions share the same schedule, changes to the schedule for one function will cause the same changes for the other functions that share the schedule.

To the right of the schedule header, an "X" will appear if the same schedule is also shared by another remote control function.

Click on the schedule's header row to see a graphical overview of when the schedule is active during the days of the week.

### 9.6.1 Defining a schedule

In this example, a night temperature reduction of heating circuit 1 (HC1) is programmed.

First, a schedule must be defined in the "Installer/Define/Remote control" menu.

Enter a schedule (1-20) in the "Schedule" column in the "HC1 Night Reduction" row using the arrow keys, or click where the cursor is in the example.

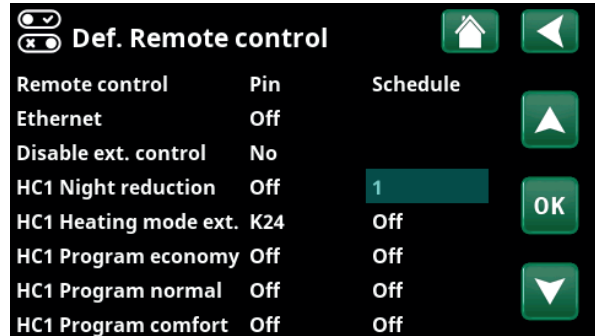

Menu: "Installer / Define / Remote Control".

The "HC1 Night Reduction" function is assigned to Schedule #1.

### 9.6.2 Schedule settings

A schedule can be set for most remotely controlled functions in the menus under "Installer/Settings".

However, schedules for "Night reduction", "Extra DHW" and "Ventilation" can only be accessed via the start menu.

The schedule includes 30 rows and a setting can be made in each row. For example, in one row you can set the date and time for the function to activate, and the time the function should deactivate in the row below.

In the example, "Night reduction" for heating circuit 1 has been set to be "On" from 22:30 to 07:00 on weekdays, except for weekends (Friday and Saturday nights).

The second row is highlighted green, which means that row is active at the current time.

**Schedule** **Active**  
(Active/Inactive/Restore factory settings)

Activate the schedule by setting it to "Active" mode. It is also possible to restore factory settings.

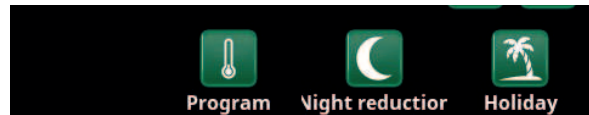

Click on the "Night Reduction" icon in the heating circuit "Heating/Cooling" menu to set the schedule.

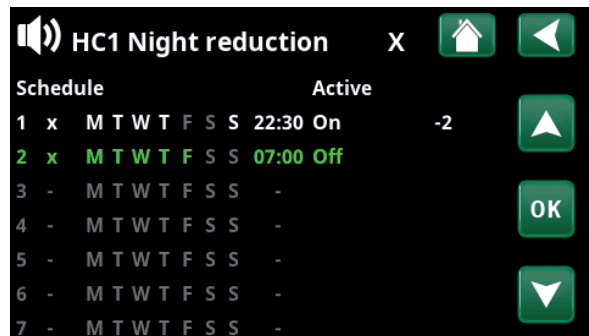

The schedule has been set for "Night Reduction" to be active weekdays between 22:30 and 07:00, except during the night between Friday and Saturday and the night between Saturday and Sunday (when no night reduction occurs).

### 9.6.3 Editing a schedule

Go down to the first row and press "OK" to enable editing mode.

#### Time

Use the arrow keys to change the time (hours and minutes, respectively).

#### Day by day

Use the arrow keys (up arrow /down arrow) to mark active days in bold.

#### Action Off (On/Off)

This normally indicates whether the row will switch the function "On" or "Off".

However, for the "Night Reduction" and "SmartGrid Schedule" functions, the following applies:

- In the schedule for "Night Reduction", the temperature reduction that will apply during the period is specified in °C here instead. When a temperature is specified (setting range -1 to -30 °C), the status of the row automatically switches to "On".
- When setting a "SmartGrid schedule", the SmartGrid function (SG Block., SG Low price and SG Overcapacity) is specified in the "Action" row. The status of the row automatically switches to "On".

#### Active Yes (Yes/No)

"Yes" means that the row is activated.

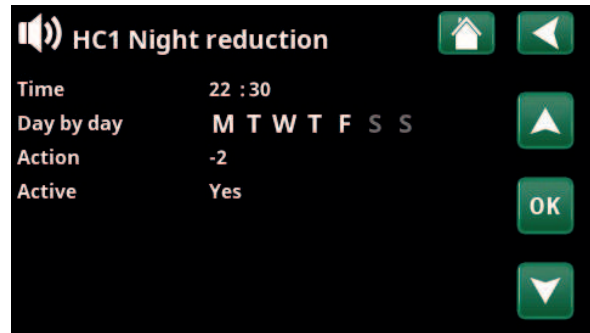

Setting the Night Reduction (-2 °C), weekday nights.

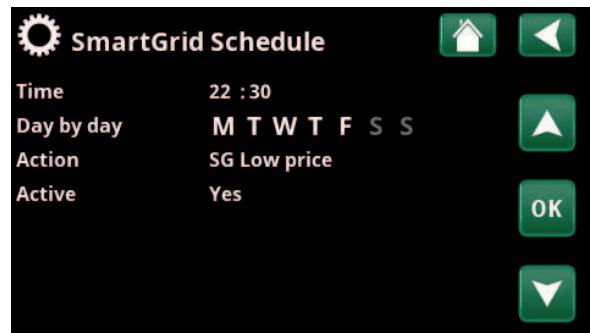

The SmartGrid function "SG Low Price" is scheduled for weekdays 22:30-06:00. Go to the menu by selecting "SmartGrid schedule" in the "Installer/Settings" menu.



## 9.7 Operation data

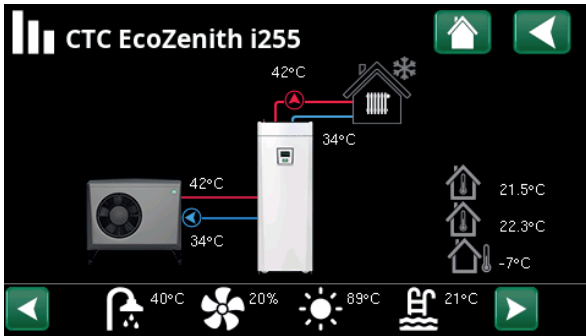

The screen shows operational data with the CTC EcoAir connected. When the pumps are in operation, the pump icons also rotate on screen.

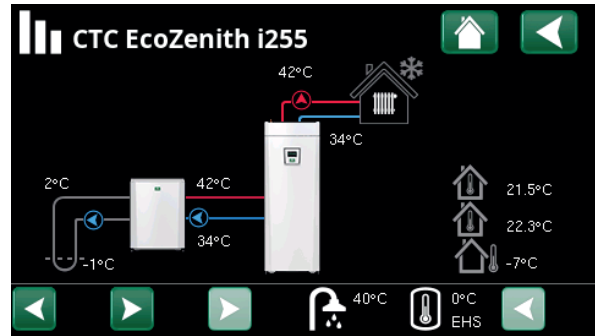

The screen shows operating information with the CTC EcoPart connected. When the pumps are in operation, the pump icons also rotate on screen.



Outside Temperature

Measured temperature, outdoor sensor.



Indoor temperature

Shows the room temperature for defined heating circuits (room sensors 1 and 2).



Brine temperature

Current temperature (2 °C) of the brine from the collector in the heat pump and return temperature (-1 °C) of the brine back into the collector hose.



Heating circuit

Current primary flow temperature (42 °C) to the house is shown on the left. Current return temperature (34 °C) is shown below.



Heat pump, air-to-water

The air-to-water heat pump is connected and defined for the circuit. The in and out temperatures of the heat pump are shown on the right.



Heat pump, brine-to-water

The brine-to-water heat pump is connected and defined for the circuit. The in and out temperatures of the heat pump are shown on the right.

The icon bar at the bottom of the menu page displays icons for additional functions or subsystems that have been defined.

Scroll using the arrows or swipe in the list if not all the icons fit on the page.

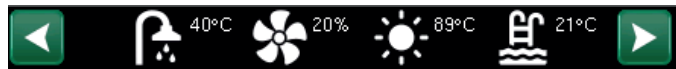

Ventilation



Pool



Solar Panel



El.prices



DHW



History



Diff. thermostat function

The gear icon is a shortcut to "Settings" for the respective part.



## 9.7.1 Operation data, Control unit

**Status** HP upper

Current charging mode, see table below.

**Tank upper °C** 49 (60)

Temperature and setpoint in the upper part of the tank.

**Tank lower °C** 42 (50)

Temperature and setpoint in the lower part of the tank.

**Electric power kW** 0.0 + 2.5

Electric boiler's additional power. Lower and upper immersion heaters. Example of 0.0 kW in lower immersion heater and 2.5 kW in upper immersion heater.

**Current L1/L2/L3 A** 8.6 / 9.1 / 8.9

Total current consumption of the house at the various phases L1/L2/L3, provided that three current sensors have been fitted to incoming cables in the house. If the current sensors mounting devices are not identified, only the phase with the highest load is displayed.

If the current exceeds the main fuse size, the boiler automatically switches down a power step to protect the fuses, for example, when several high-consumption appliances are being used in the house.

Three values are displayed for "Current" when the current transformers are connected and identified. If only one digit is displayed:

- connect all three current transformers.
- then select in the "Installer/Service/Check current sensors" menu.

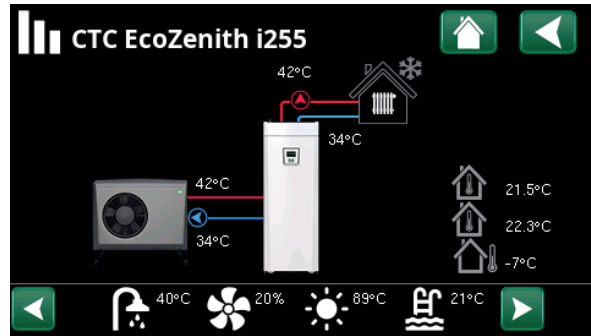

Main menu page for operation data of the defined system.

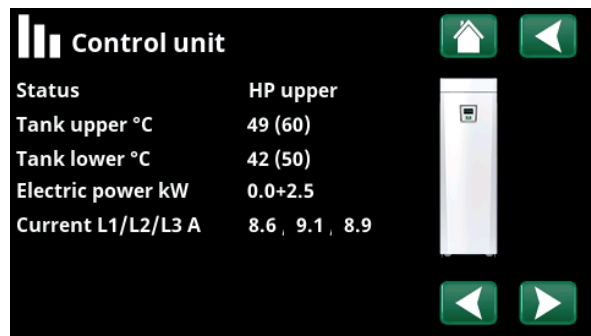

Menu: "Operation Data/Control Unit". Click the arrows or swipe to switch between the Control Unit and Heat Pump.

**i** The first figure indicates the current operational value, and the value in brackets indicates the setpoint which the heat pump is trying to achieve.

Control unit status	
HP upper	The heat pump heats the upper part of the tank (DHW production).
HP lower	The heat pump heats the lower part of the tank. (Heat production).
HP+Add. Heat	Both the immersion heater and heat pump heat the tank.
Additional heat	Only the immersion heater heats the tank.



## 9.7.2 Operation data, Heating circuit\*

**Mode** Custom

Shows the active DHW program.

**Status** Heating

Shows the operational status of the heating circuit. See the table below.

**Primary flow °C** 42 (48)

Temperature and setpoint (in brackets) supplied to heating circuit.

**Return flow °C** 34

Temperature returned to heating circuit.

**Room temp. °C** 21 (22) (25)

Shows the room temperature for the heating circuit if room sensor installed. In brackets, the setpoint is shown for the "Heating" and "Cooling" status.

**Radiator pump** Off

Radiator pump mode (On/Off)

**Mixing valve** Open <50%

Shows whether the mixing valve increases (opens) or decreases (closes) the heating flow to heating system 2 and when the mixing valve is in the "<50%" or ">=50%" position.

**Delay mixing valve** 25

A microswitch in the mixing valve's motor ensures that auxiliary heating is not used unnecessarily, for example, when ventilating a room or if the temperature (outdoors) occasionally drops during the night. The mixing valve is delayed for the time period selected before auxiliary heating is used. The screen shows the countdown of the delay in minutes. If "Blocked" is shown, never open the mixing valve towards the upper tank immersion heater.

**SmartGrid** Off

Shows the status of the SmartGrid functions for the selected heating circuit.

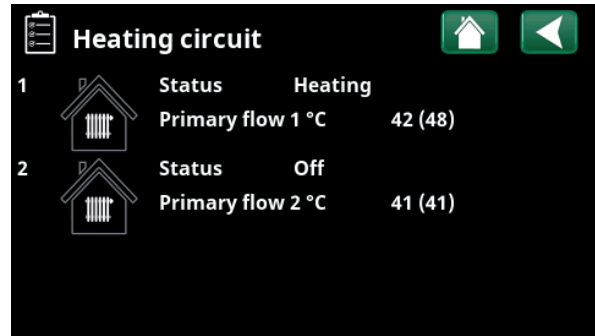

"Operation data, heating circuit" menu. The menu shows the current temperatures and status of defined heating circuits.

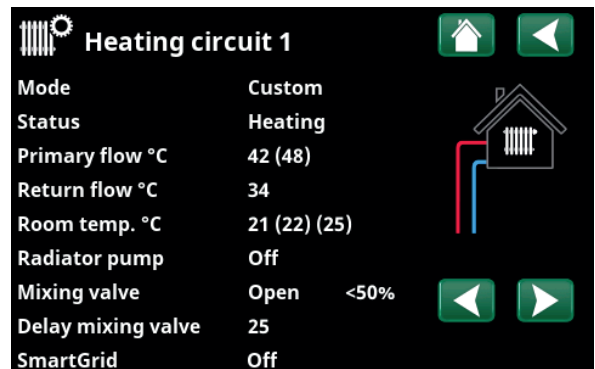

The menu shows detailed operation data of the selected heating circuit. Click the arrows or swipe sideways to view defined heating circuits.

\*The heat pump can control up to 2 heating circuits.

Heating circuit status	
Heating	Heat is produced for the heating circuit.
Cooling	Cooling is produced for the system.
Holiday	Room temperature Holiday reduction active.
Night reduction	Room temperature Night reduction active.
Off	No heating/cooling produced.



### 9.7.3 Operation data, Heat pump (air-to-water)

<b>Status</b>	<b>On, heating</b>
Heat pump status, see table below.	
<b>Model</b>	<b>EcoAir 622M</b>
Shows the heat pump model.	
<b>Compressor</b>	<b>65RPS R</b>
Shows the compressor speed. "R" stands for "Reduced Mode" (for example, during "Silent Mode").	
<b>Charge pump</b>	<b>On 68%</b>
Shows operating status of the charge pump ("On" or "Off") and the flow in percent (0-100).	
<b>Fan</b>	<b>On 80%</b>
Shows operating status of the fan ("On" or "Off") and the fan speed in percent.	
<b>HP in/out °C</b>	<b>35.5 / 42.3</b>
Shows the heat pump's incoming and outgoing temperatures.	
<b>Outdoor temperature °C</b>	<b>3.0 (-50...50)</b>
Shows outdoor temperature.	
<b>Defrost timer</b>	<b>30</b>
Shows the time remaining until the heat pump enters defrosting mode. For the defrosting to start, the temperature in the heat pump's evaporator must be low enough.	
<b>Current A</b>	<b>9.8</b>
Shows the current across the compressor.	
<b>Software HP PCB</b>	<b>20220518</b>
Shows the heat pump software version.	

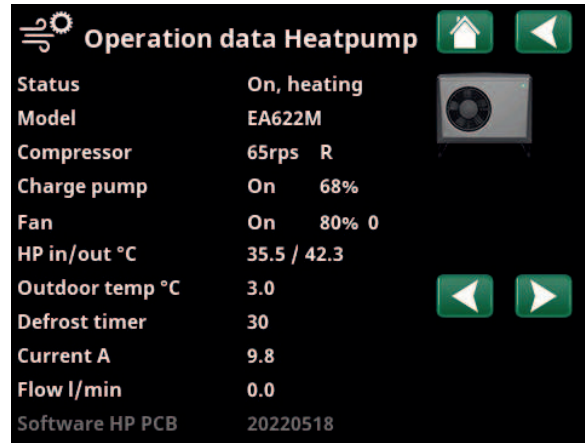

Menu: "Operation data, Heat pump".

Heat pump status	
On	The heat pump is in the "On" position.
On, DHW	The heat pump heats the DHW tank.
On, cooling	The heat pump is producing cooling for the heating circuit
On, heating	The heat pump is producing heat for the heating circuit.
Start delay: 1 min.	Compressor off - prevented from starting due to 1 min. start delay.
Off	Heat pump not charging the tank - no need.
Blocked in menu	Compressor Blocked in the "Installer/Settings/Heat Pump" menu.
Communication error HP	Control unit not communicating with heat pump.
Off, start ready	Compressor off but ready to start.
Driver block under voltage	Driver operating voltage too low.
Defrost	Defrosting in progress – air-to-water heat pump only.
Stop, low outdoor temp	Outdoor temperature lower than minimum limit – air-to-water heat pump only.
Off, alarm	Compressor off – alarm activated.
Stop, tariff	Compressor blocked due to active remote control function.
Blocked, low brine in °C	Incoming brine temperature too low, compressor blocked.
Flow on	Flow in the charging coil.



## 9.7.4 Operation data, Heat pump (brine-to-water)

<b>Status</b>	<b>On, heating</b>
Heat pump status, see table below.	
<b>Model</b>	<b>EcoPart 410</b>
Shows model of selected heat pump.	
<b>Compressor</b>	<b>On (On/Off)</b>
Shows whether the compressor is operating or not.	
<b>Charge pump</b>	<b>On 50%</b>
Shows operating status of the charge pump ("On" or "Off") and the flow in percent (0-100).	
<b>Brine pump</b>	<b>On 78%</b>
Shows operating status of the brine pump ("On" or "Off") and the speed in percent.	
<b>Brine in/out °C</b>	<b>2.0 / -1.0</b>
Shows the heat pump's return and primary flow brine temperatures.	
<b>HP in/out °C</b>	<b>35.5 / 42.3</b>
Shows the heat pump's incoming and outgoing temperatures.	
<b>Current A</b>	<b>0.0</b>
Shows the current across the compressor.	
<b>Software HP PCB</b>	<b>20220427</b>
Shows the heat pump software version.	

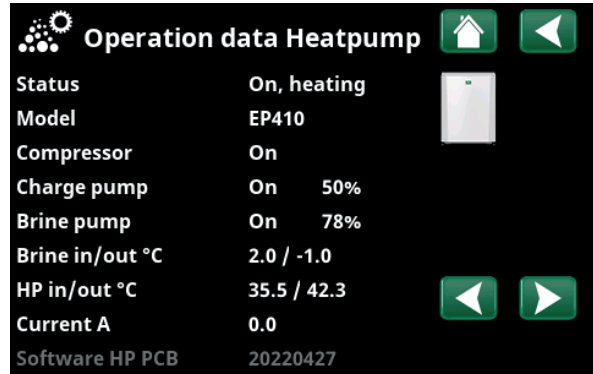

The menu shows detailed operation data of the selected heat pump.

Heat pump status	
On, DHW	The heat pump heats the DHW tank.
On, heating	The heat pump is producing heat for the heating circuit.
Start delay: 1 min.	Compressor off - prevented from starting due to 1 min. start delay.
Off	Heat pump not charging the tank - no need.
Blocked in menu	Compressor Blocked in the "Installer/Settings/Heat Pump" menu.
Communication error HP	Control unit not communicating with heat pump.
Off, start ready	Compressor off but ready to start.
Driver block under voltage	Driver operating voltage too low.
Off, alarm	Compressor off – alarm activated.
Stop, tariff	Compressor blocked due to active remote control function.
Blocked, low brine in °C	Incoming brine temperature too low, compressor blocked.
Flow on	Flow in the charging coil.





### 9.7.5 Stored Operation data

This menu shows cumulative operation values.

The operation values shown in the menu screenshots are only examples. The historical operational info presented varies depending on the language choice.

**Total operation time h** 3500

Shows the total time the product has been powered.

**Max primary flow °C** 51

Shows the highest temperature that has been supplied to the heating circuit.

**Energy el. total (kWh)** 250

Shows how much additional heat has been used.

#### Compressor

**Operation time /24 h:m** 07:26

Shows total operating time during the last 24 hours.

**Total operation time** 1500

Displays total compressor operating time in hours.

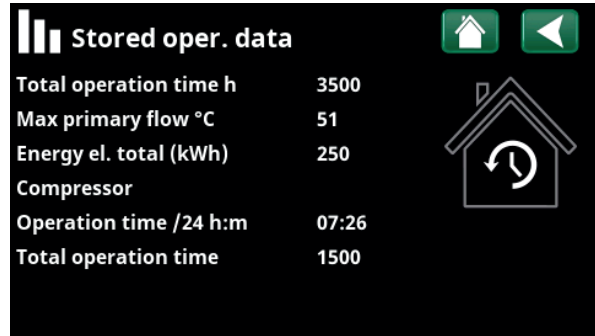

Menu: "Stored oper. data".



### 9.7.6 Operation data, DHW

**Mode** Normal

Shows the active DHW program (Economy/Normal/Comfort).

**Tank upper °C** 49 (60)

Temperature and setpoint in the upper part of the tank.

**Extra DHW** On

"On" means the "Extra DHW" function is active.

**SmartGrid** SG Low price

If SmartGrid is defined, the current status is displayed. This affects DHW production.



"Operation Data/DHW" menu.



### 9.7.7 Operation data, Diff thermostat function

**Status** On

Shows whether the charge pump is turned on ("On"/"Off").

**Temperature °C** 51

Temperature in tank **from** which it is charged.

**Target temp. °C** 43

Temperature in tank that it is charged **to**.

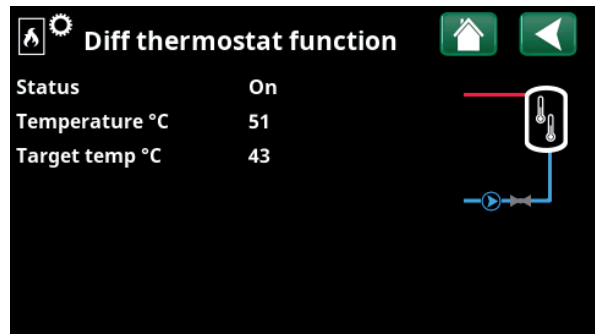

Menu: "Operation Data/Diff. thermostat function".



### 9.7.8 Operation data, El.prices

This menu is displayed if "El.prices" has been defined in the "Installer/Define/Communication" menu.

**El.price mode** **High**

Indicates the current price category ("High", "Medium" or "Low").

**El.price/kWh** **SEK 7.5**

Indicates the current electricity price in local currency.

Display the "Preview data" graph by clicking the "Graph icon" at the bottom-left of the menu screen.

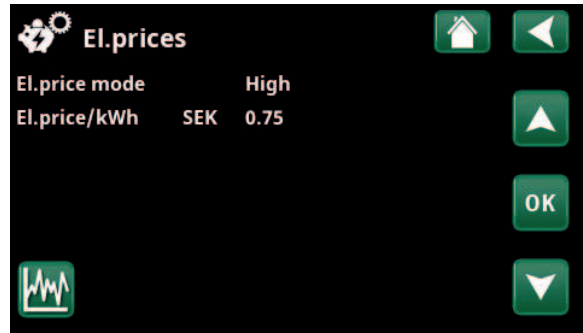

Menu: "Operation/El.prices".

For more information and examples of Smart Electricity Price Control/SmartGrid, see the website [www.ctc-heating.com/Products/Download](http://www.ctc-heating.com/Products/Download).



### 9.7.9 External signal

The menu shows the functions that are active via external control. The functions can be activated with:

- myUplink
- Virtuell digital in
- Modbus
- Relay
- SmartControl sensors

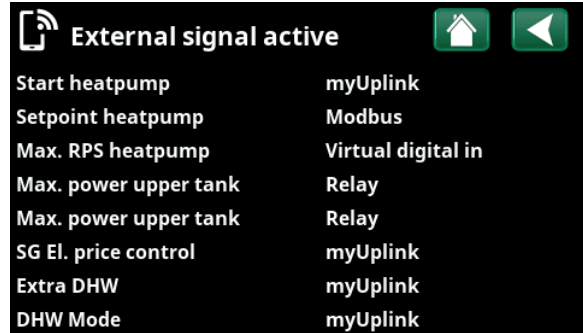

Menu: "Operation/External signal active".



## Installer

This menu contains four sub-menus:

- Display
- Settings
- Define
- Service



For "System Information", click the "i" button in the lower right corner of the screen in the "Installer" menu. This displays the product serial number, MAC address, and application and bootloader versions. Click "Legal Information" to view information regarding third-party licences.

Scan the QR code with a tablet or smartphone. When your phone/tablet is connected to your local network, the product can be used with your device's touchscreen in the same way as the product's screen.

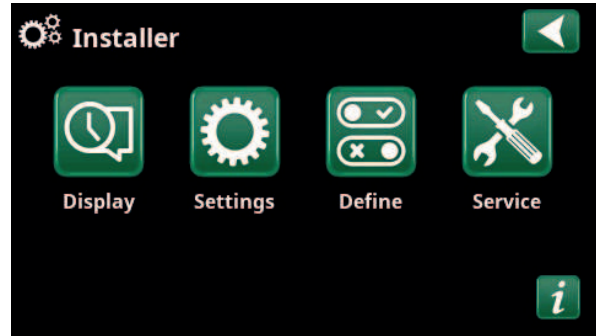

Menu: "Installer".

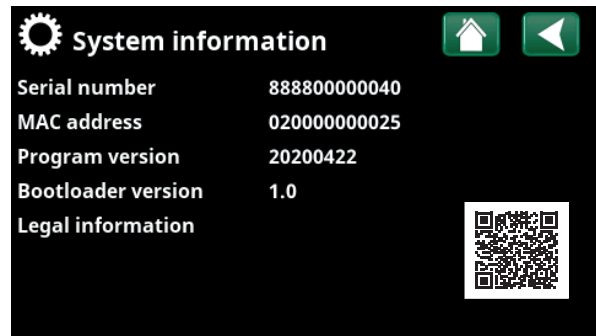

Menu: "Installer/System information". To access this menu, click the "i" button in the lower right corner of the "Installer" menu.



## 9.8 Display

Time, language and other screen settings can be carried out from this menu.



### 9.8.1 Setting the time

#### Time and Date

Click on the time symbol. The menu can also be accessed by clicking the date or time in the upper right corner of the start screen.

Press "OK" to highlight the first value and use the arrows to set the time and date.

#### DST (On, Active)

The left value can be set. "On" means the time is adjusted according to Summer Time.

The right value is fixed and shows the current status (for example, "Off" during the winter period). The display does not need to be connected to power for the values to be adjusted, since this occurs at the next start-up.

#### SNTP

Menu option "On" retrieves the current time from the internet (if online). More settings options can be found in the "Installer/Settings/Communication/Internet" menu.

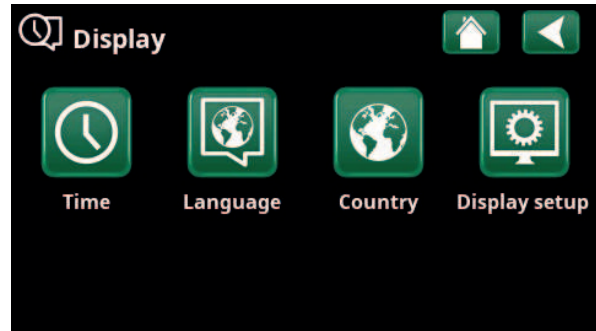

Menu: "Installer/Display".

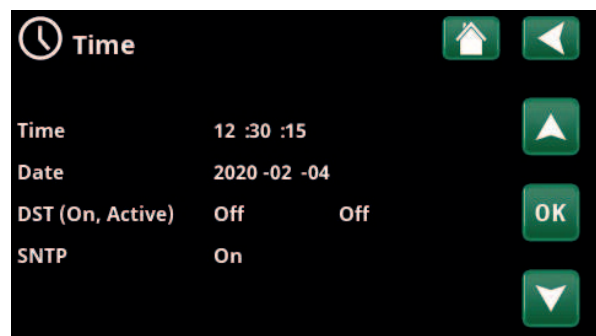

Menu: "Installer/Display/Time".



### 9.8.2 Language

Click a flag to select the language. The language selected is highlighted with a green square. To view more language options than those shown in the menu, scroll down the page, or press the down arrow key.



### 9.8.3 Country

Click on the "Country" symbol in the "Installer/Display" menu to display selectable countries and regions. The country that is displayed (highlighted in green) depends on which language has been selected.

"English" is the default language setting, which means that "GB United Kingdom of Great Britain and Northern Ireland" is the default country setting.

Select the country where the plant is installed to get correct spot prices. Depending on which country is selected, product-specific factory settings may vary.

"Country" must also be selected to receive correct electricity prices when controlling electricity prices via the myUplink mobile app.



### 9.8.4 Display setup

**Sleep delay** 120 (Off, 1...360)

Enter the time in minutes before the display enters sleep mode if not touched. Settings can be applied in 10 min. intervals.

**Backlight** 80% (10...90)

Set the brightness of the backlit display.

**Click sound** Yes (Yes/No)

Enable or disable button sounds.

**Alarm sound** Yes (Yes/No)

Enable or disable alarm sounds.

**Time zone, GMT +/-** +1 (-12...14)

Set your time zone (relative to GMT).

**Lock code** 0000

Press "OK" and use the arrows to set a 4-digit lock code. If a lock code is set, it is shown as four stars. You will be prompted to enter the code when the screen is restarted.

NB: Make a note of the lock code for your own reference when you enter it in the menu for the first time.

The serial number of the display (12 digits) can also be entered to unlock the display (enter '0000' + serial number); see chapter "Installer/System Information".

The display can be locked by clicking the product name in the upper left of the start menu, whereupon you will be prompted to enter the lock code.

A lock code can be deleted by entering "0000" in this menu instead of the previously specified lock code.

**Font size** Standard (Small/Standard/Large)

The display's font size can be changed here.

**Selection colour** 0 (0/1/2)

Option to change the cursor background colour for clearer selection according to the light conditions.

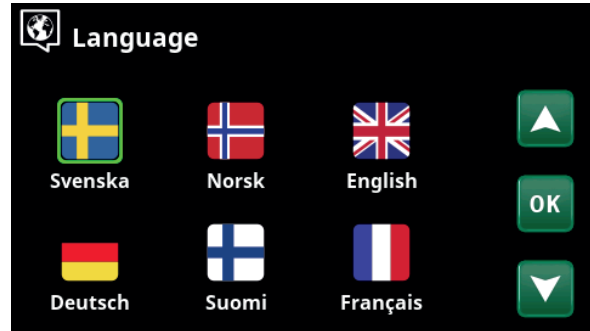

Menu: "Installer/Display/Language".



Menu: "Installer/Display/Country".

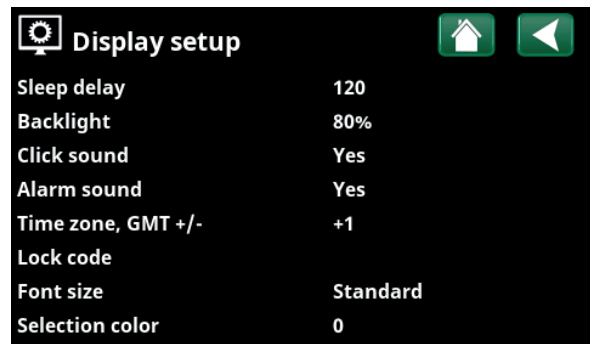

Menu: "Installer/Display/Display Setup".



## 9.9 Settings

This is used to set the parameters for your home's heating requirements. It is important that this basic setting is right for your home. Values which are set incorrectly may mean that your property is not warm enough or that an unnecessarily large amount of energy is being used to heat your property.

**i** First define the desired functions, see "Installer/Define". Settings are only displayed for enabled functions.

### 9.9.1 Settings Heating circuit\*

In the "Settings" menu, select "Heating circuit" and then the heating circuit to be set.

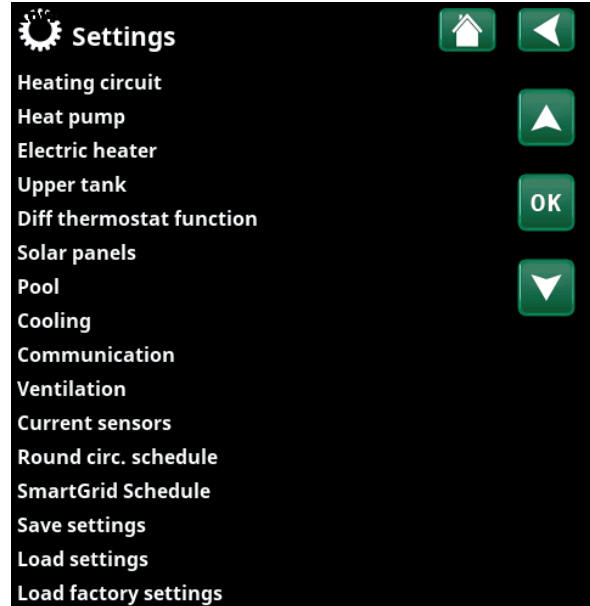

Menu: "Installer/Settings".

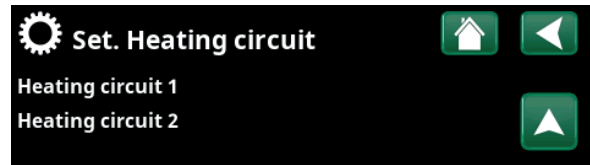

Part of the "Installer/Settings/Heating Circuit" menu.

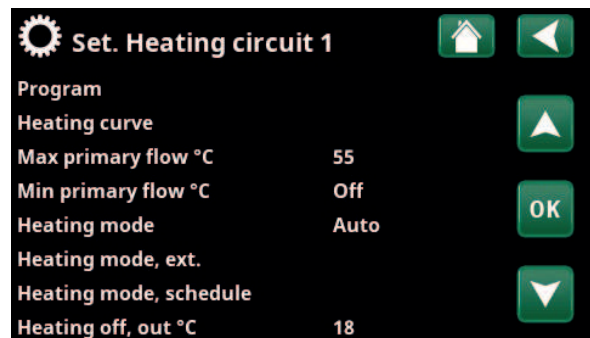

Part of the "Installer/Settings/Heating Circuit/Heating Circuit 1" menu.

\*The heat pump can control up to 2 heating circuits.

## Program

Press "OK" on the "Program" menu bar to make settings for the "Economy", "Comfort" and "Custom" heating programs. Selected programme is marked with an "X".

To activate a heating program or set a schedule, press the "Program" button from the "Heating/Cooling" menu. See chapter "Control system / heating/cooling".

### • Primary flow change °C -5 (-20...-1)

The menu bar is displayed if the room sensor is not defined for the heating circuit. Setting "-5" (factory value program "Economy") means that the setpoint of the primary flow is lowered by 5 °C when the program is active.

### • Room temp change °C -2.0 (-5.0...-0.1)

The menu bar is displayed if the room sensor is defined for the heating circuit. Setting "-2" (factory value program "Economy") means that the setpoint for room temperature is lowered by 2 °C when the program is active.

### • Off delay, min No (No/10...600)

Off delay means the time in minutes after the heating program "Economy", "Comfort" or "Custom" has been activated as the heating mode returns to the program "Normal". However, if the "Custom" program is selected later than the "Normal" program, the "Custom" program will apply after the Off delay. The Off delay is adjusted in steps of 10 minutes for each key press (up or down arrow).

"No" means that the selected program will be activated until another heating program is activated.

### • SmartGrid Blocking\* Off (Off/On)

The menu bar is displayed when setting the heating programme "Economy" or "Custom".

"On" means that the heating program is activated when "SmartGrid Blocking" is active.

### SmartGrid Low price\* Off (Off/On)

The menu bar is displayed when setting the heating programme "Comfort" or "Custom".

"On" means that the room temperature is increased according to the setting for "SmartGrid Low price °C" when "SmartGrid Low price" is active.

### SmartGrid Overcapacity\* Off (Off/On)

The menu bar is displayed when setting the heating programme "Comfort" or "Custom".

"On" means that the room temperature is increased according to the setting for "SmartGrid Overcapacity °C" when "SmartGrid Overcapacity" is active.

### • Reset program

Current program is reset with factory values.

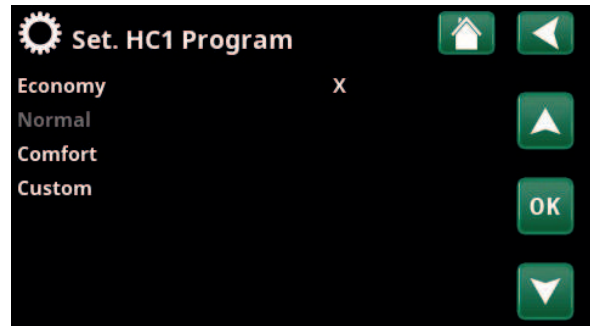

Menu "Installer/Settings/Heating Circuit/Heating Circuit 1/Program".

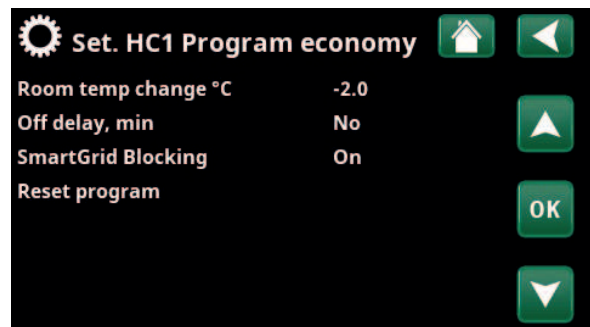

Menu "Installer/Settings/Heating Circuit/Heating Circuit 1/Program/Economy".

\*SmartGrid functions are set in the menu "Installer/Settings/Heating circuit".

## Heating curve

The heating curve determines the primary flow temperature (and thus the indoor temperature) to the heating circuit at different outdoor temperatures.

See chapter "Your home's heating installation" for more information on adjusting the heating curve.

Possible choices are "Set. heating curve", "Fine adjustment", "Active curve", "Copy from ..." and "Reset curve".

### • Set. heating curve

The thicker line shows the factory-set curve while the thinner line shows the active heating curve to be reset. Here it is possible to adjust the appearance of the graph by adjusting the curve inclination and curve adjustment with the buttons below the graph. The adjustments you make here affect the entire appearance of the graph, while the changes made under "Fine adjustment" are made one point at a time. Curve inclination is adjusted with the left and right arrows while curve adjustment is adjusted with the up and down arrows. Confirm with "OK".

### • Fine adjustment

The graph of the active heating curve for the heating circuit is displayed. The heating curve can be adjusted in 5 points on the graph. Touch a point (becomes green) to change its position in the x-axis (outdoor temperature) and y-axis (primary flow temperature). Use the up/down/left/right buttons below the graph or press and drag the point.

Below the graph, the outdoor and primary flow temperatures for the selected point are shown. The heating curve can also be adjusted from the "Heating/Cooling" menu. See chapter "Control system / heating/cooling".

### • Active curve 1 (1/2)

This menu bar shows the selected heating curve, it is possible to choose between two different heating curves per heating circuit.

### • Copy from 1 (2)

The function "Copy from ..." is useful if you have created two different heating curve graphs but want to restore one graph to the same appearance as the other and then make changes.

Example: If heating curve 1 is selected as "Active curve", heating curve 1 will have the same appearance as heating curve 2 by selecting the line "Copy from 2" and pressing "OK". The menu bar cannot be selected (marked with gray) when heating curves 1 and 2 have the same values (the graphs look the same).

### • Reset curve

Resets the active heating curve to the factory-set curve.

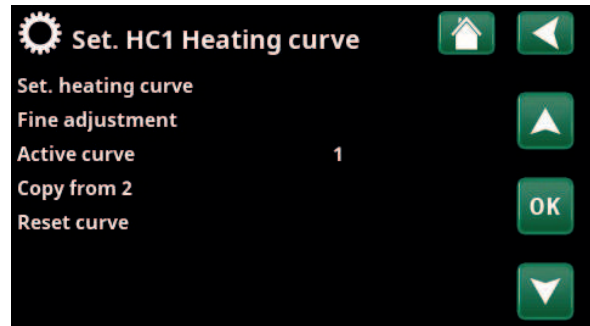

Menu "Installer/Settings/Heating Circuit/Heating Circuit 1/Heating curve".

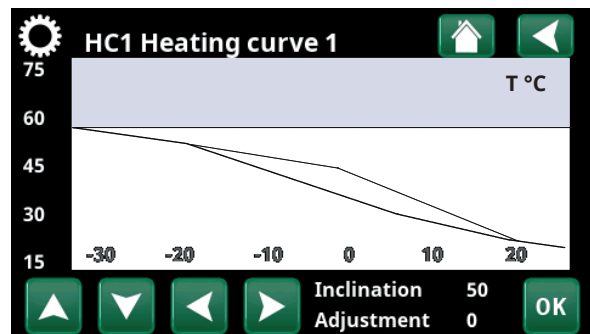

Menu "Installer/Settings/Heating Circuit/Heating Circuit 1/Heating curve".

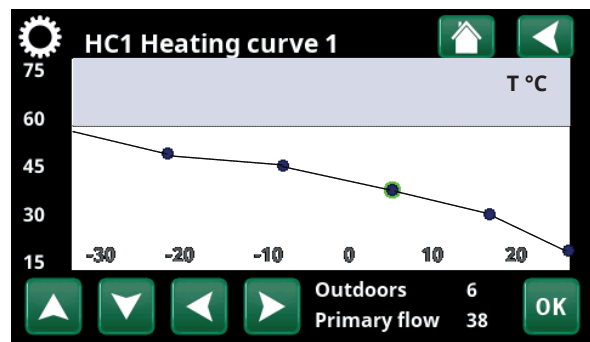

Menu "Installer/Settings/Heating Circuit/Heating Circuit 1/Heating curve/Fine adjustment".



**Max primary flow °C** 60 (30...70)

Maximum permitted temperature supplied to the respective heating circuit.

**Min primary flow °C** Off (Off/15...65)

Minimum permitted temperature supplied to the respective heating circuit.

**Heating mode** Auto (Auto/On/Off)

Switching between heating season and summer mode can take place automatically (Auto) or a selection can be made here to set the heating to "On" or "Off".

Heating mode can also be selected from the start page by pressing the "Mode" button in the Heating/Cooling menu.

- **Auto** = switching the heating season On and Off carried out automatically.
- **On** = Continuous heating season, the radiator pump circulates constantly.
- **Off** = there is no heating, the radiator pump does not run (is turned over).

**Heating mode, ext.** - (Auto/On/Off)

The heating mode selected in this menu can be enabled/disabled externally.

This menu bar is displayed for the current heating circuit if a remote control input or a schedule has been defined for the function.

Read more in the "Def. Remote Control" section of the "Installer/Define" chapter.

#### Heating mode, schedule

This menu bar is displayed if a schedule has been defined for the "HC Heating mode, ext." function in the remote control menu.

For more information, refer to:

- chapter "Schedule".
- section "Def. Remote Control" of the "Installer/Define" chapter for defining the remote control function.

**Heating off, out °C** 18 (2...30)

**Heating off, time (min)** 120 (30...1440)

**Heating on, time (min)** 120 (30...1440)

The menu bars can only be set if the "Auto" mode is selected in the "Heating mode" menu above. Otherwise, the menu bars are locked (greyed out).

When the outdoor temperature exceeds (or equals) the set value in the "Heating off, out °C" menu during the time (in minutes) set in the "Heating off, time (min)" menu, the production of heat for the house is stopped.

This means the radiator pump stops, and the mixing valve remains closed. The radiator pump is activated daily for a short period to prevent it from jamming. The system restarts automatically when heating is needed.

When the outdoor temperature drops to the limit where heating is needed again, heat to the house is permitted when the temperature falls below (or equals) the set value in the "Heating off, out °C" menu for the number of minutes set in the "Heating on, time (min)" menu.

Program	
Heating curve	
Max primary flow °C	55
Min primary flow °C	Off
Heating mode	Auto
Heating mode, ext.	
Heating mode, schedule	
Heating off, out °C	18
Heating off, time (min)	120
Heating on, time (min)	120
Night reduction down to °C	5
Room temp reduced night red °C-2	
Room temp reduced holiday °C	-2
Prim. flow reduced night red °C	-3
Prim. flow reduced holiday °C	-3
Alarm room temp °C	5
SmartGrid Low price °C	Off
SmartGrid Overcapacity °C	Off
SmartGrid Blocking	Off
Anti Water Hammer	No
HP max DHW	No
Drying period	Off
Drying period temp °C	25
Drying period mode	Off

Menu "Installer/Settings/Heating Circuit/Heating Circuit 1".



**Night reduction down to °C** **5 (-40...40)**

When the outdoor temperature is lower than this, the "Night Reduction" function stops since too much energy is consumed and it takes too long to increase the temperature again.

This menu overrides remote control of "Night Reduction".

**Room temp. reduced, Night red °C** **-2 (0...-30)****Room temp. reduced, Holiday °C** **-2 (0...-30)**

The menus are displayed if room sensors are installed for the heating circuit. The number of degrees by which the room temperature should be lowered during remote-controlled night reduction and during holidays can be set here. Night reduction can also be set periodically; the temperature decrease is then entered in the schedule.

**Prim. flow reduced, Night red °C** **-3 (0...-30)****Prim. flow reduced, Holiday °C** **-3 (0...-30)**

The menus are displayed if room sensors are not installed for the heating circuit. The number of degrees by which the primary flow temperature for the heating circuit should be lowered during remote-controlled night reduction and during holidays can be set here. Night reduction can also be set periodically; the temperature decrease is then entered in the schedule.

**Alarm room temp °C** **5 (-40...40)**

If the room temperature is too low (according to the set value), the message "Alarm, low room temp." will be displayed.

This menu bar is displayed if the room sensor is connected and defined.

**SmartGrid Low Price °C** **1 (Off/1...5)**

Setting to increase the room temperature at "Low price" energy price, via SmartGrid.

Both SmartGrid A and SmartGrid B must be defined in the remote control menu for this menu to be displayed.

Read more in the "Remote Control/SmartGrid A/B" section of the "Installer/Define" chapter.

**SmartGrid Overcapacity °C** **2 (Off/1...5)**

Setting to increase the room temperature at "Overcapacity" energy price, via SmartGrid. This function is not used for electricity price control.

Both SmartGrid A and SmartGrid B must be defined with a remote control input for this menu to be displayed.

Read more in the "Remote Control/SmartGrid A/B" section of the "Installer /Define" chapter.

**SmartGrid Blocking** **Off (Off/On)**

"On" means the heating circuit is blocked at "High" energy price, via SmartGrid. If the outdoor temperature falls below the value set in the "Night reduction down to °C" menu, this function is not activated.

Both SmartGrid A and SmartGrid B must be defined with a remote control input for this menu to be displayed.

Read more in the "Remote Control/SmartGrid A/B" section of the "Installer /Define" chapter.

● If room sensors are installed, the "Room temp reduced..." menu is displayed. If there are no room sensors, the "Primary flow reduced..." menu is displayed.

**Example**

As a rule, a "Primary flow reduced" reduced value of 3 to 4 °C is equivalent to a reduction of approximately 1 °C in room temperature in a normal system.

**Anti Water Hammer**

**No (No/Yes)**

Anti Water Hammer means that the heat pump never switches over and heats the upper tank (DHW charging). This is provided solely by the immersion heater. In summer mode however, i.e. if the outdoor temperature is above the limit (Heating off, outdoor), the heat pump will be allowed to send water to the upper tank.

**HP max DHW**

**No (Yes/No)**

When the Anti Water Hammer has been selected, the "DHW increase" function opens.

- "Yes" means that the heat pump will follow the temperature of the radiators for 3 start-ups. When the heat pump performs start-up no. 4 the heat pump works until it achieves "maximum heat pump temperature".
- "No" means that the heat pump will always follow the temperature need of the radiators.

**Drying period mode**

**Off (Off/1/2/3)**

Applies to Heating circuit 1. Drying period for newly built properties. The function limits the calculation of primary flow temperature (setpoint) for "Your home's heating settings" to the schedule below.

**Mode 1 - Drying period for 8 days**

1. The setpoint of the radiator system is set to 25 °C for 4 days.
  2. On Days 5-8, the set value in "Drying period temperature °C" is used.
- (From Day 9 onwards the value is calculated automatically according to "Your home's heating settings")

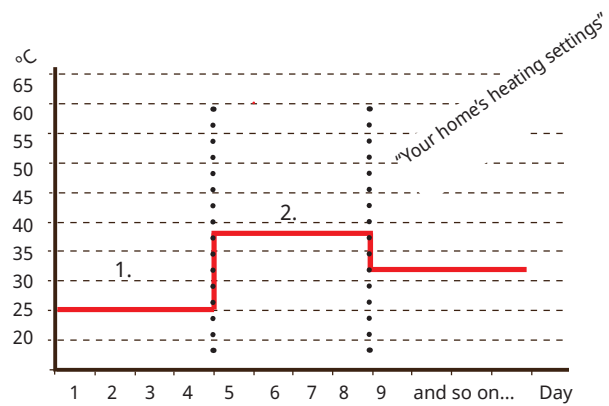

Example: Mode 1 with set value "Drying period temp °C": 38.

**Mode 2 - Drying period for 10 days + stepped increased and decrease**

1. Stepped increase start: The setpoint of the radiator system is set to 25 °C. The setpoint is then raised by 5 °C each day until it is equal to the "Drying period temp °C". The final step may be less than 5 °C.
2. Drying period for 10 days.
3. Stepped decrease: After the stepped increase and 10 days at an even temperature, the temperature setpoint is reduced to 25 °C in daily 5 °C stages. The final step may be less than 5 °C.

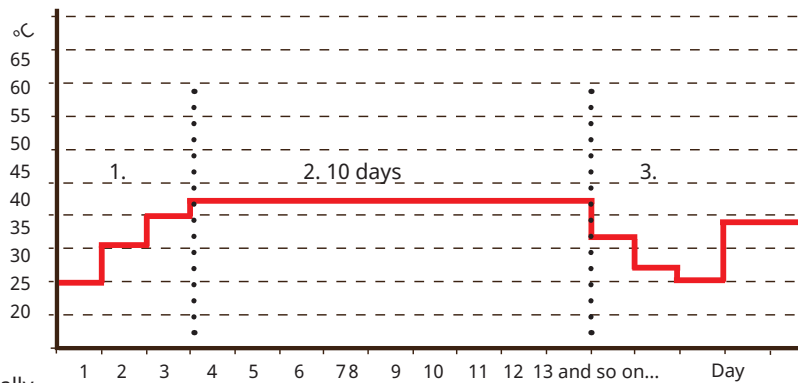

Example: Mode 2 with set value for "Drying period temp °C": 37.

(Following the stepped decrease and 1 day at the setpoint of 25 °C, the value is calculated automatically according to "Your home's heating settings").

**Mode 3**

In this mode, the function starts in "Mode 1" followed by "Mode 2" and lastly by "Your home's heating settings".

**Drying period temp °C**

**25 (25...55)**

The temperature for "Mode 1/2/3" as shown above is set here.

**Drying period mode**

**Off (Off/On)**

This menu bar is displayed for Heating Circuit 2 if a heating mode (1-3) is selected in the "Drying period mode" menu above.

The "On" option means that the drying period mode selected for Heating Circuit 1 will also be run for the selected heating circuit.

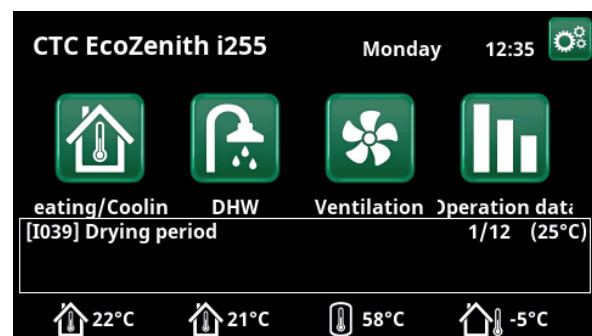

Example: Drying period temperature day 1 of 12 with current set point of 25 °C.

## 9.9.2 Settings Heat pump

### Compressor **Blocked (Permitted/Blocked)**

The heat pump is supplied with a blocked compressor. "Permitted" means that the compressor can start.

### Stop at outdoor temp °C **-22 (-22...10)**

This menu relates to settings for the outdoor temperature at which the compressor is no longer permitted to operate. The heat pump starts 2°C above the set value.

Only applies to air-to-water heat pumps.

### Compressor stop at brine °C **-5 (-15...10)**

This menu defines the brine temperature at which the compressor will be stopped.

Only applies to brine-to-water heat pumps.

### Tariff HP **No (No/Yes)**

"Yes" means the function can be activated via remote control.

Read more in the "Def. Remote Control" section of the "Installer/Define" chapter.

### Tariff HP schedule

This menu bar is displayed if a schedule has been defined for the "HP Tariff" function.

For more information, refer to:

- chapter "Schedule".
- section "Def. Remote Control" of the "Installer/Define" chapter for defining the remote control function.

### Minimum run time (min) **6 (0...20)**

Minimum operation time in minutes that the compressor is permitted to operate. Even if the tank's stop temperature has been achieved, the compressor continues to supply energy during this period.

### SmartGrid Block. HP **No (No/Yes)**

"Yes" means that the heat pump is blocked when "SmartGrid Blocking" is active.

Read more in the "Remote Control /SmartGrid" section of the "Installer/Define" chapter.

### Max RPS **90\* (50...120)**

The maximum permissible speed of the compressor at "winter temperature". Sets the compressor's maximum speed (R2) at outdoor temperature T2.

Only applies to modulating air-to-water heat pumps.

### Max RPS warm temp **50 (50...120)**

The maximum permissible speed of the compressor at "summer temperature". Sets the compressor's maximum speed (R1) at outdoor temperature T1.

Only applies to modulating air-to-water heat pumps.

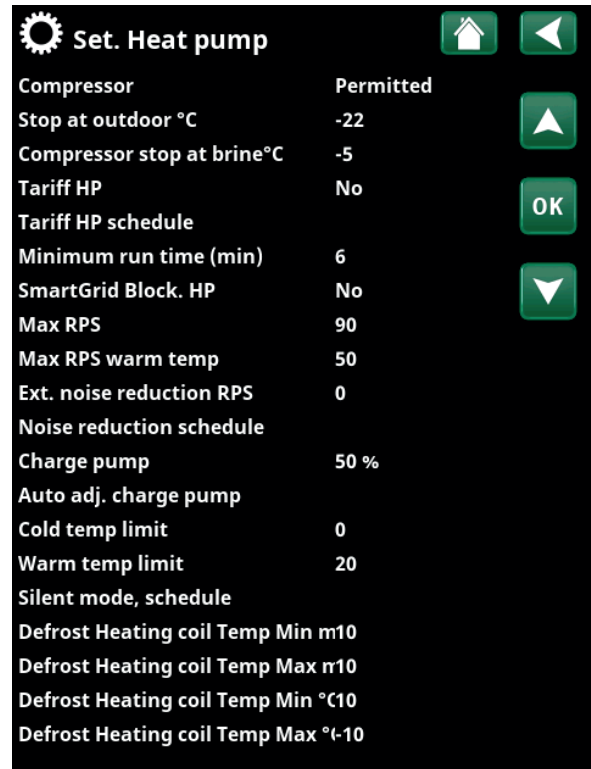

Menu: "Installer/Settings/Heat pump".

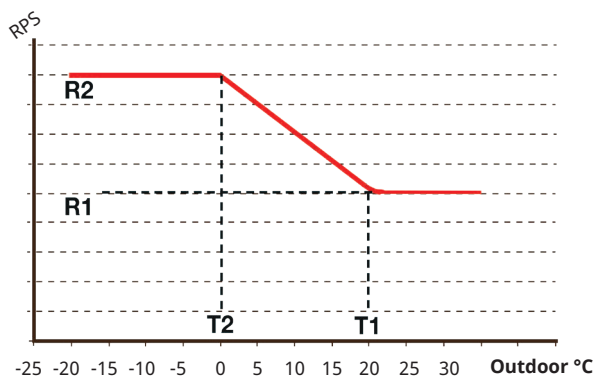

The diagram shows that the compressor speed is controlled according to the outdoor temperature.

When the outdoor temperature is below T2, the compressor speed adjusts up to R2.

When the outdoor temperature exceeds T1, the compressor speed adjusts down to R1.

These temperature and speed limits are set in the menus on the left.

**Ext. noise reduction RPS** **0 (20...-120)**

Set the compressor speed value applicable for remote control.

Read more in the "Def. Remote Control" section of the "Installer/Define" chapter.

**Noise reduction schedule**

This menu starts a schedule with limited compressor speed to reduce the noise level.

The "Schedule" chapter describes how to set schedules.

**Charge pump** **50% (In Progress, 25, 100)**

Charge pump speed in %.

The speed is calculated using the "Auto adj. charge pump" function.

The speed can also be programmed manually. If the speed is selected manually, this value is displayed in red. The value is also displayed in red on installation as "Auto adj. charge pump" has not been run.

If a value of 100 is reached and displayed in red there is insufficient flow to the heat pump.

If a value of 25 is reached and displayed in red the flow to the heat pump is higher than optimal.

**Auto adj. charge pump**

This function starts the calculation of the optimal charge pump speed. The function is activated by marking the "Auto adj. charge pump" line and pressing "OK". While calculation is in progress, "In Progress" is displayed below the "Charge Pump" row. Once calculation is complete the new value is placed in the "Charge Pump" row, e.g. 72%.

The calculation takes about 5 min. DO NOT touch the screen when the text "In Progress" is displayed.

Different operating modes and seasons may produce differing results. Any calculation should therefore be repeated after 4 weeks.

**Cold temp limit** **0 (0...-15)**

When the outdoor temperature is equal or lower (T2), the compressor speed is adjusted up to speed R2.

**Warm temp limit** **20 (0...20)**

When the outdoor temperature is equal or higher (T1), the compressor speed is adjusted down to speed R1.

The heat pump starts and stops at the actual value and setpoint value.

Only applies to modulating air-to-water heat pumps.

**Silent mode, schedule**

It is possible to start a schedule, e.g. during the night, with limited compressor speed and fan speed to reduce the noise level.

The "Schedule" chapter describes how to set schedules.

*Only applies to CTC EcoAir 600M/700M.*

**Defrost heating temp min m**                      **10 (0...360)**

Set the minimum heating time "Min m" (minutes) for the heating coil in the condensation tray at outdoor temperature T1.

**Defrost heating temp max m**                      **10 (0...360)**

Set the maximum heating time "Max m" (minutes) for the heating coil in the condensation tray at outdoor temperature T2.

**Defrost heating temp min °C**                      **10 (-40...40)**

When the outdoor temperature is this or higher (T1), the heating time is regulated down to the value set in the menu "Defrost heating temp min m".

**Defrost heating temp max °C**                      **-10 (-40...40)**

When the outdoor temperature is this or lower (T2), the heating time is regulated up to the value set in the menu "Defrost heating temp max m".

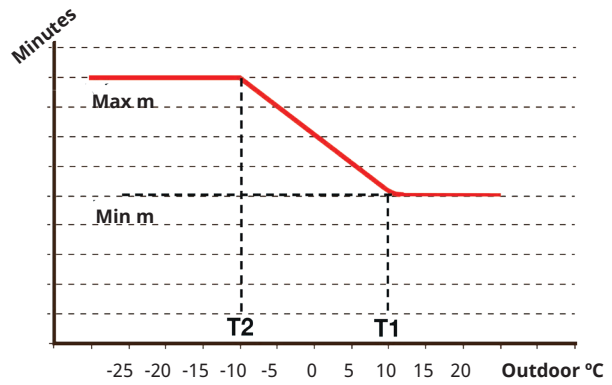

The diagram shows that the heating time of the heating coil to the condensation trays is regulated depending on the outside temperature.

When the outdoor temperature is below T2, the heating time adjusts up to "Max m".

When the outdoor temperature exceeds T2, the heating time adjusts down to "Min m".

These temperatures and times are set in the menus "Defrost heating temp..." on the left.

### 9.9.3 Settings Immersion heater

#### Boiler upper add. °C 57 (30...70)

Temperature when the immersion heater kicks in and helps EcoHeat 400 to produce DHW when there is great demand. The immersion heater is also responsible for providing the house with additional heating. If the house requires a higher temperature than that selected, the control system compensates by automatically raising the temperature of the immersion heaters.

This temperature also reflects the settings chosen under DHW.

#### Boiler upper extraDHW °C 60 (30...70)

This means the boiler is to provide extra DHW. This setting determines whether the immersion heater should help to produce extra DHW. Set the temperature of the electric unit to the desired value when the option for extra DHW is activated under the DHW menu. A lower value means the heat pump produces the majority of DHW.

#### Boiler upper max kW 5.5 (0...9.0)

Setting for the maximum permitted power for the electric unit. 0 to 9.0 kW in steps of 0.3 kW.

The setting range varies, see "Electrical data" in the chapter "Technical data". For "Country" Germany and France, the max electric power is factory set at 0.0 kW.

#### Boiler lower °C 50 (30...70)

Setting for the temperature of the lower immersion heater.

#### Boiler lower kW 6.0 (0/6.0)

Setting for the power of the lower immersion heater, 0 and 6 kW respectively. An additional 3 kW is possible. See the chapter: Electrical installation/Switching to 18 kW immersion heater power.

The setting range varies, see "Electrical data" in the chapter "Technical data". For "Country" Germany and France, the max electric power is factory set at 0.0 kW.

#### Delay mixing valve 180 (30...240, Blocked)

The mixing valve delay, the period before it draws energy from the immersion heater, is set here. Adjustable 30 to 240 minutes. If the value is set to "Blocked", the mixing valve will never open to the boiler.

#### Main fuse A 20 (10...35)

The property's main fuse size is set here. This setting and the fitted current sensors ensure the fuses are protected when using appliances which generate temporary power peaks, for example, cookers, ovens, engine heaters, etc. The product temporarily reduces power drawn where this type of equipment is being used.

#### Conv. factor curr. sensors 1 (1...10)

This menu contains the factor the current sensor is to use. This setting is only performed if the connection has been installed for a current sensor for higher currents.

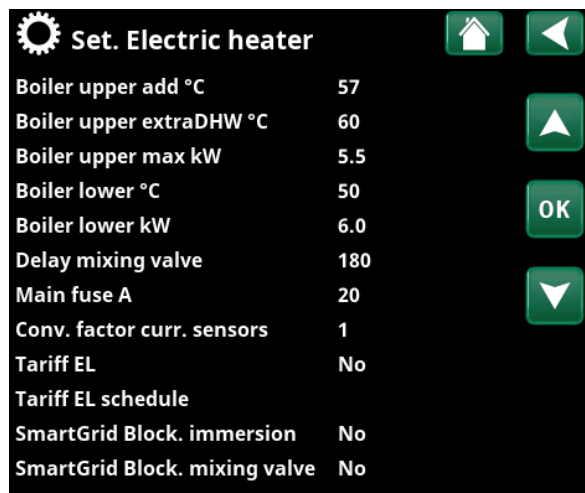

Menu: "Installer/Settings/Immersion heater".

**Tariff EL****No (Yes/No)**

This menu bar is displayed if an "Input" for remote control is defined for the "Tariff EL" function in the "Installer/Define/Remote Control" menu.

"Yes" means the function can be activated via remote control.

Read more in the "Installer/Define/Remote Control/Tariff EL" chapter.

**Tariff EL schedule**

This menu bar is displayed if a "Schedule" is defined for the "Tariff EL" function in the "Installer/Define/Remote Control" menu.

For more information, refer to:

- chapter "Schedule".
- section "Def. Remote Control" of the "Installer/Define" chapter for defining the remote control function.

**SmartGrid Block. immersion****No (Yes/No)**

For this menu to be displayed, define a remote control input for both SmartGrid A and SmartGrid B.

"Yes" means that the additional heat is blocked when "SmartGrid Blocking" is active.

Read more in the "Installer/Define/Remote Control" chapter.

**SmartGrid Block. mixing valve****No (Yes/No)**

The menu bar is displayed if the "SmartGrid block immersion" selection on the row above is "Yes".

When blocked, the mixing valve for the heating circuit does not open more than 50% if the need arises.

"Yes" means the function can be activated via remote control.

## 9.9.4 Settings Upper tank

### DHW program

Available options are "Economy", "Normal" and "Comfort".

Press "OK" to open the settings for the selected DHW program. The factory settings shown below apply to "Normal" mode. Refer to the "Parameter List" chapter for the "Economy" and "Comfort" modes' factory settings.

#### • Stop temp HP °C **60 (40...60)**

At the selected temperature, the heat pump stops charging the upper tank.

#### • Boiler upper °C **40 (30...60)**

Hot water charging starts when the temperature falls below the set temperature.

#### • Reset program

The current DHW program will be reset to factory settings.

#### Start/stop diff. upper °C **5 (3...10)**

Temperature diff. before the heat pump starts or stops charging the upper tank.

#### Max time upper tank (min) **30 (10...150)**

This is the maximum time in minutes spent by the heat pump charging the upper tank if required in the lower tank.

#### Max time lower tank (min) **20 (10...120)**

This is the maximum time in minutes spent by the heat pump charging the lower tank if required in the upper tank.

#### SmartGrid Blocking °C **Off (Off/-1...-50)**

The setpoint for DHW tank heating is decreased by the value set in this menu when "SmartGrid Blocking" is active.

Both SmartGrid A and SmartGrid B must be defined in the remote control menu for this menu to be displayed.

Read more in the "Def. Remote Control /SmartGrid A/B" section of the "Installer/Define" chapter.

#### SmartGrid Low price °C **Off (Off/1...30)**

The setpoint for DHW tank heating is increased by the value set in this menu when "SmartGrid Low price" is active.

Both SmartGrid A and SmartGrid B must be defined in the remote control menu for this menu to be displayed.

Read more in the "Def. Remote Control /SmartGrid A/B" section of the "Installer/Define" chapter.

#### SmartGrid Overcapacity °C **Off (Off/1...30)**

The setpoint for DHW tank heating is increased by the value set in this menu when "SmartGrid Overcapacity" is active.

Both SmartGrid A and SmartGrid B must be defined with a remote control input for this menu to be displayed.

Read more in the "Def. Remote Control /SmartGrid A/B" section of the "Installer/Define" chapter.

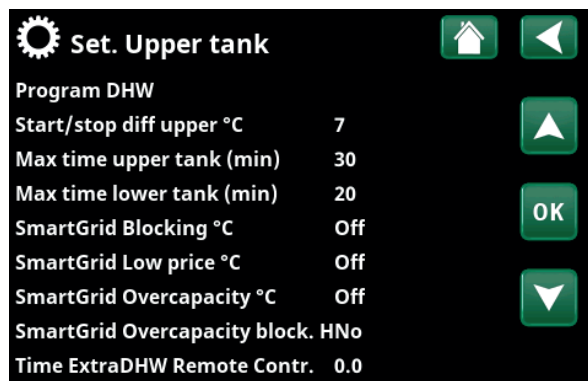

Menu: "Installer/Settings/Upper tank".

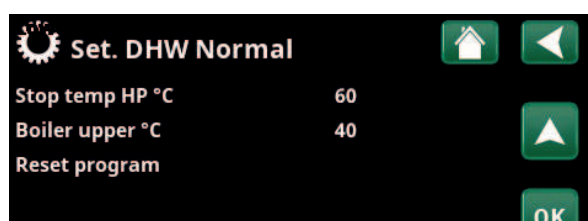

Menu: "Installer/Settings/Upper tank/DHW Program/DHW Program Normal".

#### SmartGrid Overcapacity block HP **No (No/Yes)**

"Yes" means that DHW tank heating using the heat pump is blocked when "SmartGrid Overcapacity" is active.

#### Time ExtraDHW Remote Contr. **0.0 (0.0...10.0)**

Time in full or half hour intervals during which the "Extra DHW" function is enabled when activated in the Remote Control menu (Installer/Define system/Remote control/Extra DHW), or when activated by a CTC SmartControl accessory For CTC SmartControl functionality and settings, please refer to the relevant manual.



## 9.9.5 Settings Lower tank

### SmartGrid Low price °C Off (Off/1...30)

The setpoint for lower tank heating is increased by the value set in this menu when "SmartGrid Low price" is active.

Both SmartGrid A and SmartGrid B must be defined in the remote control menu for this menu to be displayed.

### SmartGrid Overcapacity °C Off (Off/1...30)

The setpoint for lower tank heating is increased by the value set in this menu when "SmartGrid Overcapacity" is active.

Both SmartGrid A and SmartGrid B must be defined with a remote control input for this menu to be displayed.

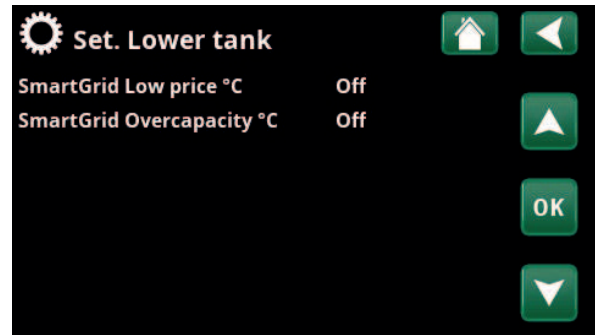

Menu: "Installer/Settings/Lower tank".

## 9.9.6 Settings Diff thermostat function

The function must be defined before the settings can be entered. Diff thermostat function is used to charge the system tank from a different heat source.

**Charge start diff temp °C** 7 (3...30)

Here you can set the temperature difference determining when charging from the heat source is started. The heat source must be this many degrees warmer than the tank temperature for charging to start.

**Charge stop diff temp °C** 3 (2...20)

The temperature difference which determines when charging from the heat source is stopped is set here. When the temperature difference between the product and the tank falls below this set value, charging stops.

**Charge temperature °C** 60 (10...80)

The maximum permitted temperature in the lower tank is set here. The charging stops if this temperature is exceeded.

**Charge tank** No (No/Yes)

Overcharging from the heat pump's lower tank to the buffer tank starts when:

- Setting menu bar "Charge tank" = "Yes".
- "SmartGrid Low price" or "SmartGrid Overcap." is active and a temperature increase via SmartGrid is set in the lower tank.
- The heat pump charges the buffer tank and the temperature in the lower tank is 5 °C higher than the previous set point\* and the temperature in the buffer tank is 5 °C lower than the previous set point\*.

Overcharging to the buffer tank continues until:

- The heat pump stops charging the lower tank (the need to charge the tank has disappeared).
- The temperature in the lower tank has dropped to the setpoint.
- "SmartGrid Low Price/Overcap." is not active.

**Block diff thermostat** No (No/Yes)

"Yes" means the function can be activated via remote control.

**Block diff th. schedule**

Access function scheduling from the "Block diff th. schedule" row.

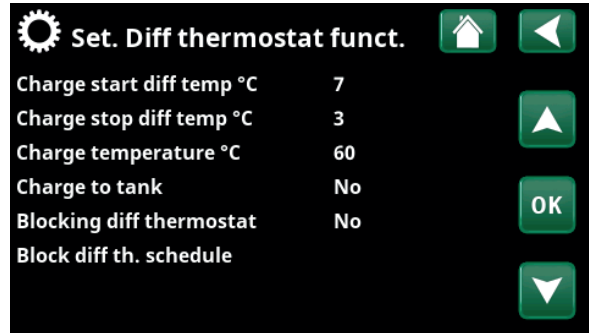

Menu: "Installer/Settings/Diff thermostat function".



Ensure a high flow on the pump (G46) so that a low temperature difference of approx. 5–10°C is achieved over the EHS tank during charging.

\*Previous setpoint means the setpoint before "SmartGrid Low Price" or "SmartGrid Overcap." was activated.

## 9.9.7 Settings Cooling

**Room temp. cooling °C** 25.0 (18...30)

This is used to set the desired room temperature for cooling.

**Active delay** 10 (Off/1...600)

Delay refers to the time (minutes) before the production of cooling is allowed when there is a need for cooling.

**Start delay** 180 (Off/1...240)

The menu determines the delay time (minutes) from the time the cooling has been blocked (see menu bars "Ext. block cooling" and "Block cooling schedule") until the production of cooling is permitted again.

**SmartGrid Low price °C** Off (Off/1...5)

The setpoint for room temperature is decreased by the value set in this menu when "SmartGrid Low price" is active.

The menu bar is displayed if SmartGrid have been defined in the "Installer/Define/Remote Control" menu.

Read more in the "Remote Control/SmartGrid" section of the "Installer/Define" chapter.

**SmartGrid Overcapacity °C** Off (Off/1...5)

The setpoint for room temperature is decreased by the value set in this menu when "SmartGrid Overcapacity" is active.

The menu bar is displayed if SmartGrid have been defined in the "Installer/Define/Remote Control" menu.

Read more in the "Remote Control/SmartGrid" section of the "Installer/Define" chapter.

**Ext. block cooling** No (No/Yes)

Selecting "Yes" enables blocking of cooling. The function can be used to turn off cooling with the help of a humidity sensor when there is a risk of condensation.

### Block cooling schedule

This menu is used to schedule the weekday periods during which cooling should be blocked. This schedule is repeated every week.

This menu bar is displayed if a "Schedule" has been defined for the "Block Cooling" function.

For more information, refer to:

- chapter "Schedule".
- section "Def. Remote Control" of the "Installer/Define" chapter for defining the remote control function.

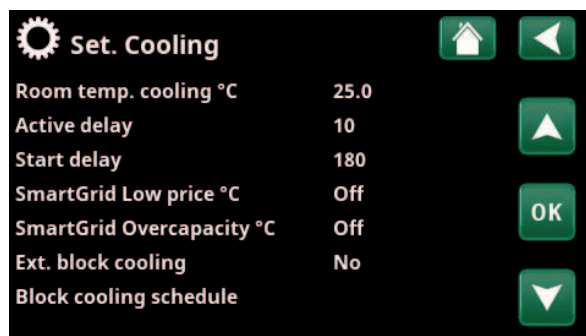

Menu: "Installer/Settings/Cooling".



A room sensor must always be used in that part of the property which is to be cooled, as it is the room sensor which determines/controls cooling capacity.

## 9.9.8 Settings Communication

Settings can be made here to control the product with a control system.

### 9.9.8.1 Settings Ethernet

**DHCP** Yes (Yes/No)

"Yes" enables automatic connection to the network.

If "No", custom router settings (IP address, Netmask and Gateway) as well as DNS setting must be made.

**Auto DNS** Yes (Yes/No)

If "Yes", default DNS server settings are used. If "No", custom DNS settings must be made.

**SNTP Server**

Option for custom SNTP server settings.

**Connection speed** 100mbit

Connection speed is specified here.

The factory-set connection speed is 100 mbit/s.

 For more information about connecting an ethernet cable, refer to the "Installation, Communication" chapter of this manual.



Menu: "Installer/Settings/Communication".

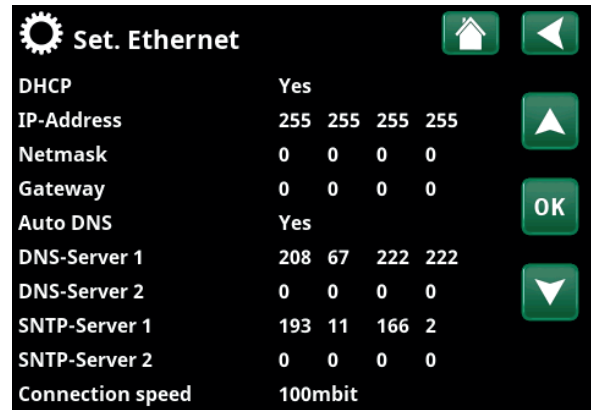

Menu: "Installer/Settings/Communication/Internet".

### 9.9.8.2 Settings BMS

**MB address** 1 (1...255)

Adjustable "1-255".

**Baudrate** 9600 (9600/19200)

Possible settings: "9600" or "19200".

**Parity** Even (Even/Odd/None)

Possible settings: "Even", "Odd" or "None".

**Stop bit** 1 (1/2)

Possible settings: 1 or 2.

**Modbus TCP Port** 502 (1...32767)

This menu bar is displayed if "Modbus TCP" is defined in the "Ethernet" row in the "Installer/Define/Remote Control" menu.

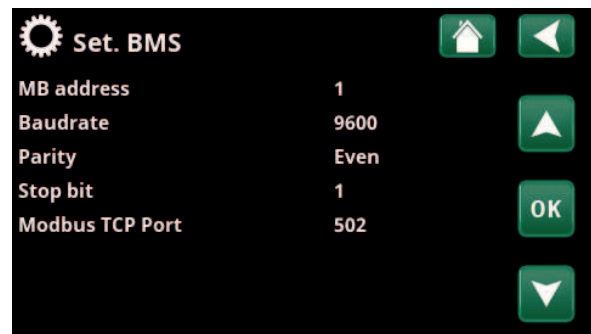

Menu: "Installer/Settings/Communication/BMS".

### 9.9.8.3 myUplink

The menu is used for pairing with the myUplink app. Request connection string by pressing "Get connection string", confirm with "OK". The menu bar is clickable if the display is connected to the server.

In the app: Scan the QR code or enter values for "Serial number" and "Connection string".

Select the menu items "Remove users" and / or "Remove service partners" to disconnect these accounts from the system. Confirm with "OK".



Menu: "Installer/Settings/Communication/myUplink".

#### 9.9.8.4 Settings El. prices

Ensure that "myUplink" is selected in the "Def. Communication" menu.

Select "El.prices" in the "Installer/Settings/Communication" menu to access the "Set. El.prices" menu.

##### Price control On/Off

Select "On" to show the other menu lines of the "Set. El.prices" display menu.

##### Regions SE01/SE02/SE03/SE04

Click "OK" on the "Regions" line. If "Regions" are defined for the selected country (see "Installer/Display/Country" menu), price regions for the country are shown here. Otherwise, the text "No regions available" is displayed. In this example, Swedish price regions are displayed.

##### Dynamic Yes/No

"Yes" means that the electricity prices are calculated according to price algorithms that define the price categories ("High", "Medium" and "Low").

Click "OK" on the "Preview data" line to display a graph of electricity prices calculated over the selected time interval ("Days in calculation").

The graph can also be displayed by clicking the "El.prices" icon in the "Operation" main menu (see "Operation" section).

##### Limit value high

Set the limit value above which the electricity price is defined as "High" (in the example, the limit value is SEK 3.50). This can be used together with the dynamic price calculation feature to define a different "High" price range than that determined by the dynamic price calculation feature.

Prices defined as "High" activate the "SmartGrid Blocking" function.

##### Limit value low

Set the limit value below which the electricity price is defined as "Low" (in the example, the limit value is SEK 1.50). This can be used together with the dynamic price calculation feature to define a different "Low" price range than that determined by the dynamic price calculation feature.

Prices defined as "Low" activate the "SmartGrid Low price" function.

##### Default High/Medium/Low

Select the price category that should apply if prices cannot be retrieved.

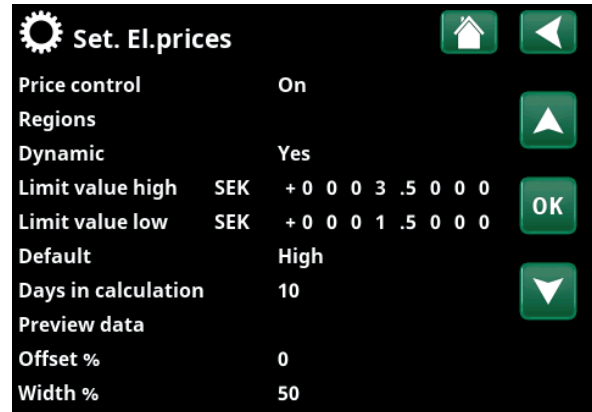

Menu: "Installer/Settings/Communication/El.prices" where "Installer/Define/Communication/myUplink:Yes" is selected.

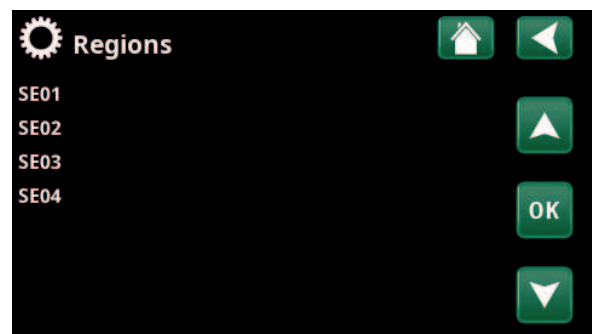

Menu: "Installer/Settings/Communication/El.prices/Regions" where "Installer/Define/Communication/myUplink:Yes" is selected

For more information and examples of Smart Electricity Price Control/SmartGrid, see the website [www.ctc-heating.com/Products/Download](http://www.ctc-heating.com/Products/Download).

### Days in calculation

1...10

Select the number of days on which the dynamic calculation of the electricity price will be based. Since the dynamic calculation is based on the average price per day, more days in calculation result in a more stable and reliable value.

See also the "Example: Electricity price settings" section.

### Preview data

Click "Preview data" to show electricity prices during the selected period in graph form.

### Offset %

0 (0...100)

Enter code "4003" in the "Installer/Service/Coded settings/Code" menu to display the "Offset %" menu line.

"Offset" is the boundary between where "High" price and "Medium" price electricity is determined and is based on the average price for the number of days used in the calculation.

See also the "Example: Electricity price settings" section.

### Width %

50 (0...200)

Enter code "4003" in the "Installer/Service/Coded settings/Code" menu to display the "Width %" menu line.

"Width" is the vertical price range where the electricity price is considered "Medium".

See also the "Example: Electricity price settings" section.

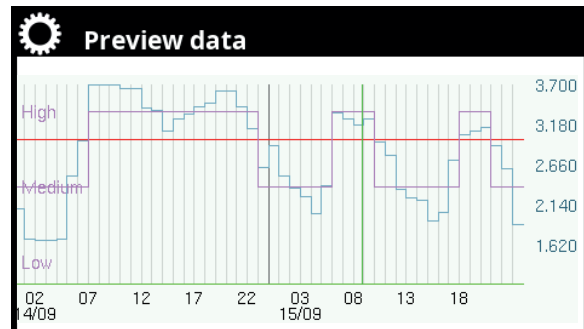

Menu: "Installer/Settings/Communication/El.prices/Preview data".



Menu: "Installer/Service/Coded settings/Code".

### 9.9.9 Settings Current sensor

These menu bars are displayed if "Current Sensor" is defined in the "Installer/Define Current Sensor" menu.

In the menu, specify the phases (L1, L2 and L3) to which the current sensors have been connected.

In the lower left corner of the screen, "Invalid configuration" will be displayed until L1, L2, and L3 are paired with the three current sensors in the menu.

When activating the "Auto config. current sensors" function, it is important that you have switched off all devices in the house that consume high levels of electricity. Also make sure that the backup thermostat is switched off.

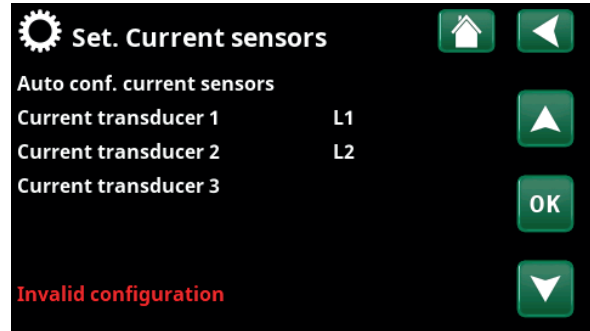

Menu: "Installer/Settings/Current Sensors".

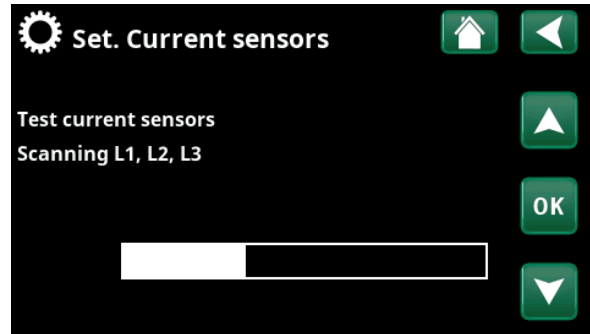

Menu: "Installer/Settings/Current Sensors /Auto config. current sensor".

### 9.9.10 Settings Round circulation schedule

Round circulation is equipment which an electricity supplier can fit in order to disconnect, for a short period of time, equipment which draws high current. The compressor and electrical output are blocked when Round circulation is active.

This menu bar is displayed if a schedule has been defined for the "Round circulation" function.

The "Round circulation" function can also be controlled remotely by activating the "Input" defined for the function.

For more information, refer to:

- chapter "Schedule".
- section "Def. Remote Control" of the "Installer/Define" chapter for defining the remote control function.

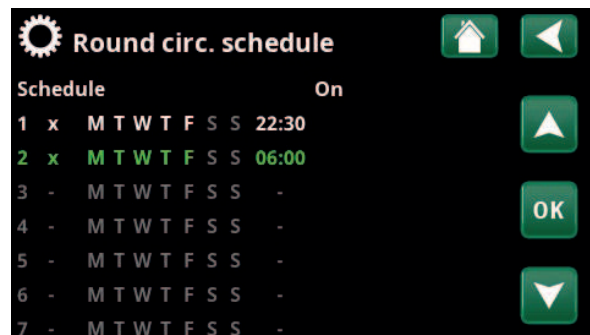

Menu: "Installer/Settings/Round circulation".

### 9.9.11 Settings SmartGrid schedule

This menu is used to schedule the weekday periods during which the "SmartGrid" functions should be active. This schedule is repeated every week.

"SmartGrid" can be used to block a function ("SG Block.") or to achieve a temperature increase during periods when the energy price is low ("SG Low price") or ("SG Overcapacity").

SG Normal mode can be used to easily deviate from any SmartGrid settings for the system on specific days/at specific times.

The "SmartGrid schedule" menu bar is displayed if a schedule has been defined in the "SmartGrid A" row.

For more information, refer to:

- chapter "Schedule".
- chapter "Installer/Define/Remote Control" for defining SmartGrid.

### 9.9.12 Save settings

Custom settings can be saved to "Bank" 1-3 and on a USB drive here. The "USB" row is greyed out until the USB drive is installed. The rows show the date and time of saved settings.

Press "OK" to confirm.

### 9.9.13 Load settings

The saved settings can be recovered.

Press "OK" to confirm.

### 9.9.14 Load Factory settings

The product is supplied with the factory values set. Saved settings in "Bank" 1-3 are deleted when factory settings are restored. The selected language is recovered.

Press "OK" to confirm.



Menu: "Installer/Settings/SmartGrid schedule".

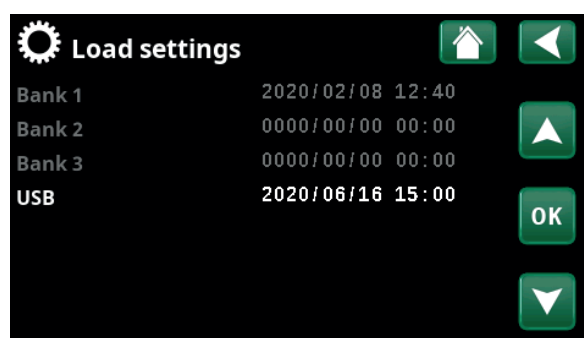

Menu: "Installer/Settings/Load My Settings".





## 9.10 Define

The "Define" menus specify which components and subsystems the system consists of.

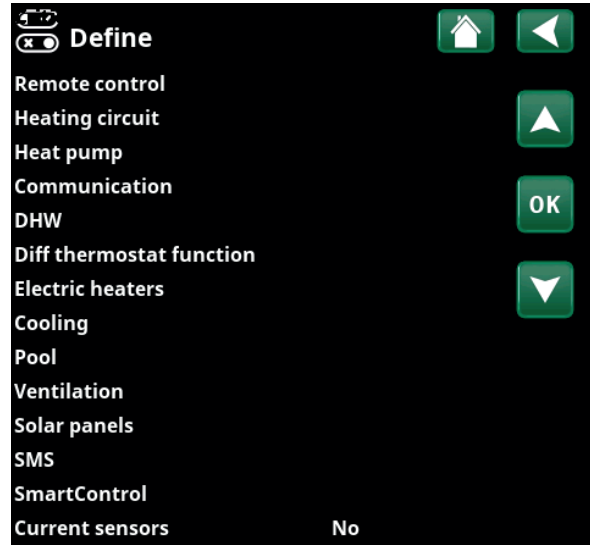

Menu: "Installer/Define".

### 9.10.1 Def. Remote control

This chapter describes all remote control functions; how they are set up and how they are used.

The "Installer/Define/Remote Control" menu defines how the remote control inputs should be activated by specifying one of the following three modes of activation in the "Input" column of this menu:

- a terminal block K22-K23 on the relay card (A2) has power or terminal block K24-K25 is closed. There are two 230 V inputs and two low voltage ports. See table below.
- wireless accessories in the CTC SmartControl series consist of wireless sensors and control units that control signals for temperature, humidity and carbon dioxide level.
- BMS control where control signals are transmitted via the BMS interface.

If you want a function to recur during weekdays, you can set when the function should be active/inactive in a schedule.

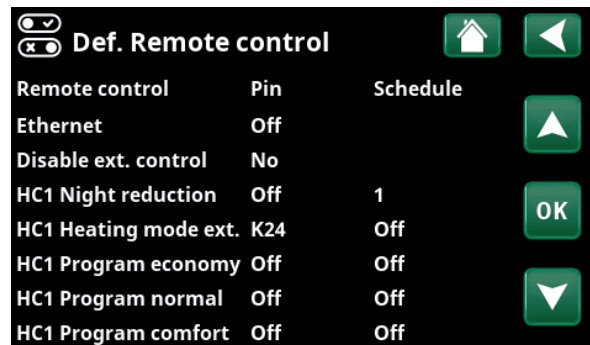

Part of the "Installer / Define/Remote Control" menu.

Designation	Terminal block position	Connection type
K22	A14 & A25	230V
K23	A24 & A25	230V
K24	G33 & G34	Extra-low voltage (<12V)
K25	G73 & G74	Extra-low voltage (<12V)

The table shows the remote control inputs K22-K25 on the relay card.

### 9.10.1.1 Setting the remote control function, example

#### 1. Define an "Input"

First, an input must be assigned to the function or functions to be controlled remotely. This is done in the "Installer/Define/Remote Control" menu.

In the example, terminal block K24 is selected as the input for the "HC1 Heating mode, Ext." function.

#### 2. Configure the function (Normally Open (NO)/Normally Closed (NC))

Define a normal mode for the external control signal; NO or NC. The setting is made for the current heating circuit in the "Installer/Define/Heating Circuit" menu.

For example, a two-way switch can be connected to the defined input.

If the button when used generates a control signal on the input (circuit closes), the circuit shall be defined as NO. When the circuit closes and the control signal is generated, the heating mode selected in the "HC1 Heating mode, ext." row is activated in the settings menu for the heating circuit.

#### 3. Setting the heating mode

In the example, the remote control function "Heating mode, ext." is set to the "Off" position in the "Heating mode, ext." row. This setting is made in the "Installer/Settings/heating circuit" menu.

In this example, the normal heating mode is active ("On").

When input K24 is closed (the multi-button in the example generates a control signal), the status of the Heating Mode (normal mode "On" > mode "Off") changes.

Heating remains off until you choose to start the heating (normal mode "On") by opening terminal block K24 (no signal on the terminal block).

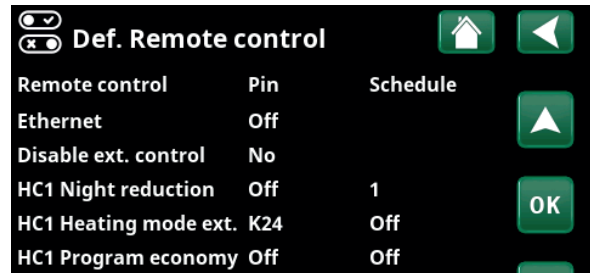

Menu: "Installer/Define/Remote Control".  
Remote control function "HC1 Heating mode, ext." is assigned to terminal block "K24".

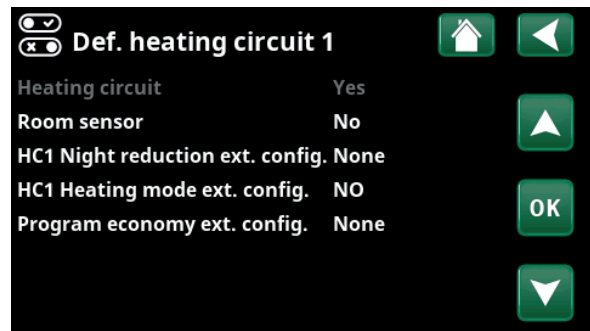

Menu: "Installer/Define/Heating Circuit/ Heating Circuit 1".  
The normal mode of the remote control signal is defined in the "HC1 Heating mode ext. config" row.

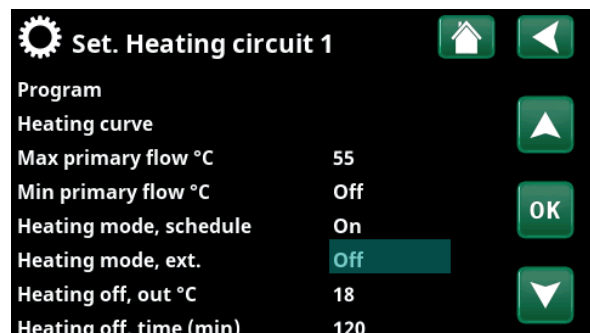

Menu: "Installer/Settings/Heating Circuit/ Heating Circuit 1" Remote control mode "Off" becomes active when terminal block K24 closes.

Open terminal block = Heating mode "On" (in this example).  
Closed terminal block = Heating mode "Off" (in this example).

### 9.10.1.2 Remote control functions

The "Installer/Define/Remote Control" menu defines Inputs for current remote control functions:

- Inputs K22, K23, K24, K25.
- wireless accessories in the SmartControl series (Channel 1A, 1B, 2A, 2B, 3A, 3B and so on up to 7B).
- BMS digital input 0-7. Specify a value 0-255. The value must be set again within half an hour for the setting to persist.

#### Ethernet (Modbus TCP/Off)

For information about Modbus TCP Port settings, refer to the "Communication" section in the "Installer/Settings" chapter.

#### Disable ext. control (Yes/No)

Selection "Yes" means disconnecting all external control of the heat pump. Schedule settings are not affected.

#### HC1- Night reduction (Off/K22-K25/Channel 1A-7B / BMS DI0-7)

The "Night Reduction" function can be used to, for example, lower the indoor temperature during the night or during working hours.

In the "Installer / Define/Remote Control" menu:

- specify an "Input" for the remote control function.

In the "Installer / Define/Heating Circuit" menu:

- configure the normal mode for the external control signal (Normally Open (NO)/Normally Closed (NC)).

The schedule can be set in the "Heating/Cooling" menu.

For more information, refer to the "Night Reduction Temperature" section in the "Heating/Cooling" chapter.

#### HC1- Heating mode, ext. (Off/K22-K25/Channel 1A-7B / BMS DI0-7)

Switching between heating season and summer season can take place at a specific outdoor temperature (Auto) or heating can be either always "On" or "Off".

In the "Installer / Define/Remote Control" menu:

- specify an "Input" for the remote control function.

In the "Installer / Define/Heating Circuit" menu:

- configure the normal mode for the external control signal (Normally Open (NO)/Normally Closed (NC)).

In the "Installer / Settings/Heating Circuit" menu:

- set "Remote Control Mode" ("On", "Off" or "Auto") in the "Heating mode, ext." row.
- Access function scheduling from the "Heating mode, schedule" row.

For more information, refer to the "Heating Circuit" section in the "Installer/Settings" chapter. Also refer to the "Your home's heating settings" chapter.

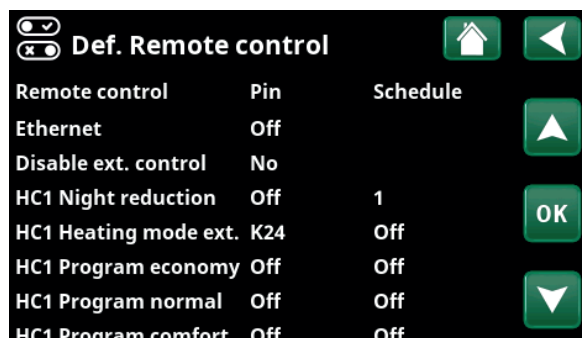

Part of the "Installer/Define/Remote Control" menu. "Input" and "Schedule" are defined here.

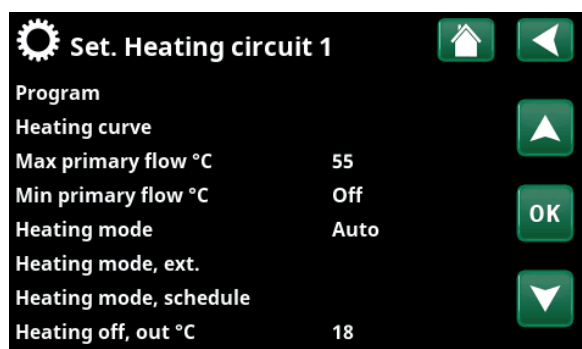

Menu: "Installer/Settings/Heating Circuit". The remote control mode for the heating circuit is set on menu bar "Heating mode, ext.". Access the schedule from the menu bar "Heating mode, schedule".

**HC1- Program economy/normal/comfort/custom ext. config. (Off/K22-K25/Channel 1A-7B/BMS DI0-7)**

The program functions "Economy", "Normal", "Comfort" and "Custom" can be used to change the indoor temperature for a certain period.

In the "Installer/Define/Remote Control" menu:

- specify an "Input" for the remote control function.

In the "Installer/Define/Heating circuit":

- configure the normal mode for the external control signal (Normally Open (NO)/Normally Closed (NC))

Setting the schedule is done from the "Heating/Cooling/Program" menu.

For more information, see section "Heating program" in chapter "Heating/Cooling".

**Extra DHW (Off/K22-K25/Channel 1A-7B/BMS DI0-7)**

Upon activation, production of extra DHW begins. When activation stops, extra DHW is produced for a run-on time of 30 min. The "Stop temperature" for extra DHW is set in the "Installer/Settings/DHW Tank/DHW program" menu.

In the "Installer/Define/Remote Control" menu:

- specify an "Input" for the remote control function.

In the "Installer/Define/DHW" menu:

- configure the normal mode for the external control signal (Normally Open (NO)/Normally Closed (NC)) in the "Extra DHW" row.

Setting extra DHW production to start immediately can also be done in the "DHW" menu. The schedule for extra DHW can also be set in this menu.

For more information, refer to the "Extra DHW" section in the "DHW" chapter.

For more information, refer to the "Upper Tank" section in the "Installer/Settings" chapter.

**Block cooling**

**(Off/K22-K25/Channel 1A-7B/BMS DI0-7)**

In the "Installer/Define/Remote Control" menu:

- specify an "Input" for the remote control function.

In the "Installer/Define/Cooling" menu:

- configure the normal mode for the external control signal (Normally Open (NO)/Normally Closed (NC)).

In the "Installer/Settings/Cooling" menu:

- set the "remote control mode" ("On") in the "Block. cooling ext. config." row.
- Access function scheduling from the "Block cooling schedule" row.

For more information, refer to the "Cooling" section in the "Installer/Settings" chapter.

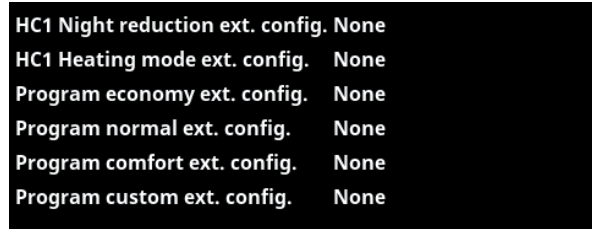

Part of the "Installer/Define/Heating circuit" menu. In the menu bars "Program economy/normal/comfort/custom ..." the normal mode is indicated on the external control signal ("Normally Open (NO)" or "Normally Closed (NC)").



Menu: "Installer/Define/DHW" On menu bar "Extra DHW", the normal mode is specified for the external control signal ("Normally Open (NO)" or "Normally Closed (NC)").

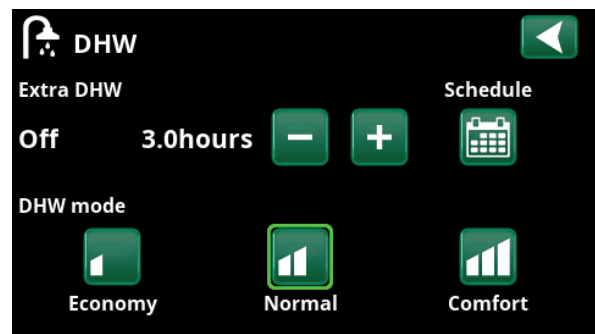

Setting the "Extra DHW" in the "DHW" menu.

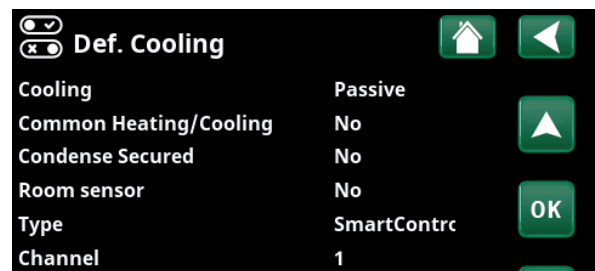

On menu bar "Block. cooling ext. config.", the normal mode is specified for the external control signal ("Normally Open (NO)" or "Normally Closed (NC)").

### Tariff EL (Off/K22-K25/Channel 1A-7B/BMS DI0-7)

This function is used to block the immersion heater during periods when the electricity rate is higher.

In the "Installer/Define/Remote Control" menu:

- specify an "Input" for the remote control function.

In the "Installer/Settings/Additional Heat" menu:

- set "remote control mode" ("Yes") in the "Tariff EL" row.
- Access function scheduling from the "Tariff EL" row.

For more information, refer to the "Additional Heat/Tariff EL" section in the "Installer/Settings" chapter.

### Round circulation

(Off/K22-K25/Channel 1A-7B/BMS DI0-7)

Round circulation is equipment which an electricity supplier can fit in order to disconnect, for a short period of time, equipment which draws high current. The compressor and electrical output are blocked when round circulation is active.

In the "Installer/Define/Remote Control" menu:

- specify an "Input" for the remote control function.

In the "Installer/Settings" menu:

- Access function scheduling from the "Round circulation" row.

For more information, refer to the "Round circulation" section in the "Installer/Settings" chapter.

### Flow/level switch

(Off/K22-K25/Channel 1A-7B/BMS DI0-7)

The flow/level switch produces an alarm on the heat pump.

In the "Installer/Define/Remote Control" menu:

- specify an "Input" for the remote control function.

In the "Installer/Define/Heat Pump" menu:

- configure the normal mode for the external control signal (Normally Open (NO)/Normally Closed (NC)) in the "Flow/level switch" row.

#### Current sensors

#### Round circ. schedule

#### SmartGrid Schedule

Part of the "Installer/Settings" menu. Setting a "Round circulation" schedule.

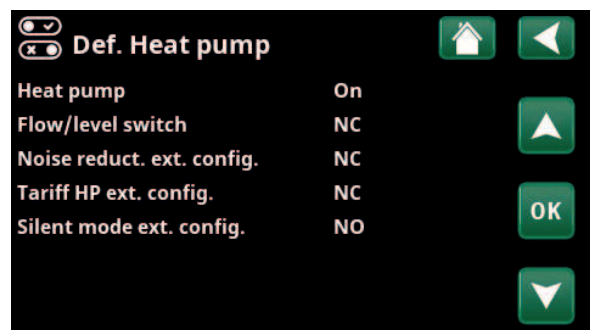

Menu: "Installer/Define/Heat Pump".

A mode for the external control signal ("Normally Open (NO)" or "Normally Closed (NC)").

## SmartGrid A / SmartGrid B (Off/K22-K25/Channel 1A-7B / BMS DI0-7)

In the "Installer/Define/Remote Control" menu:

- specify an "Input" for the remote control function.

There are three SmartGrid functions:

- SmartGrid Low Price
- SmartGrid Overcapacity
- SmartGrid Blocking

Example of "SmartGrid Low Price" for pool heating

In this example, "SmartGrid A" and "SmartGrid B" have been assigned terminal blocks K22 and K23, respectively. In addition, SmartGrid A is assigned "Schedule #1".

According to the settings in the "Set. Pool" menu, the pool setpoint will be increased by 5°C when the electricity price is low (when the "SmartGrid Low price" function is active) and the setpoint will be decreased by 10°C\* when the electricity price is high (when the "SmartGrid Blocking" function is active).

SmartGrid functions can be set (depending on system configuration/heat pump model) for Heating circuit including Heating program economy/comfort/custom, Heat pumps, Additional heating, Cooling, Pool, DHW tank, Buffer tank and Upper\* and Lower\* tank.

### Heating circuit 1-\*

- SmartGrid Blocking (Off/On)
- SmartGrid Low price °C (Off/1...5 °C)
- SmartGrid Overcapacity °C (Off/1...5 °C)

### Heating program

-Comfort:

- SmartGrid Low price °C (Off/On)
- SmartGrid Overcapacity °C (Off/On)

-Custom:

- SmartGrid Low price °C (Off/On)
- SmartGrid Overcapacity °C (Off/On)
- SmartGrid Blocking (Off/On)

-Economy:

- SmartGrid Blocking (Off/On)

### Heat pump\*

- SmartGrid Blocking HP (Yes/No)

### Additional Heat/Immersion heater

- SmartGrid Blocking EL (Yes/No)
- SmartGrid Blocking Mixing valve (Yes/No)

### Cooling

- SmartGrid Low Price °C (Off/1...5 °C)
- SmartGrid Overcapacity °C (Off/1...5 °C)

### Pool

- SmartGrid Blocking °C (Off/-1...-50 °C)
- SmartGrid Low Price °C (Off/1...50 °C)
- SmartGrid Overcapacity °C (Off/1...50 °C)

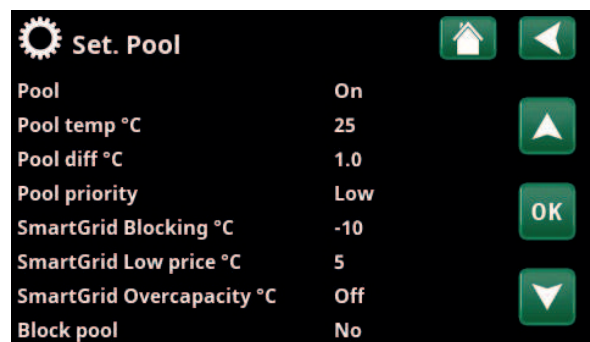

Menu: "Installer/Settings/Pool".

The pool temperature is increased by 5 °C when the SmartGrid Low Price function is activated.

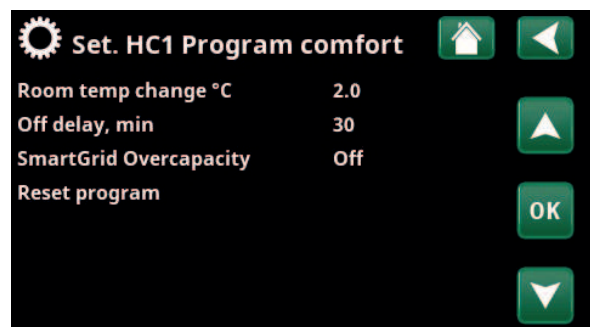

Menu "Installer/Settings/Heating Circuit/Heating Circuit 1/Program/Comfort".

\*The heat pump can control up to 2 heating circuits.

**DHW tank/Lower tank/Upper tank**

- SmartGrid Blocking °C (Off/-1...-50 °C)
- SmartGrid Low Price °C (Off/1...30 °C)
- SmartGrid Overcapacity °C (Off/1...30 °C)

**Buffer tank**

- SmartGrid Low Price °C (Off/1...30 °C)
- SmartGrid Overcapacity °C (Off/1...30 °C)

SmartGrid functions are enabled by activating the SmartGrid inputs in different ways according to the table on the right.

To enable the SmartGrid function "SG Low price" as shown in the example, terminal block K23 must have power while terminal block K22 should remain unchanged.

The pool temperature increase that will apply when "SG Low price" is activated is set in the "Pool Settings" menu, as shown in the example.

Alternatively, a schedule can be set up for periodic SmartGrid activation. For more information on setting schedules, refer to the "Schedule" section.

K22 (SG A)	K23 (SG B)	Function
Open	Open	Normal
Open	Closed	Low price
Closed	Closed	Overcapacity
Closed	Open	Blocking

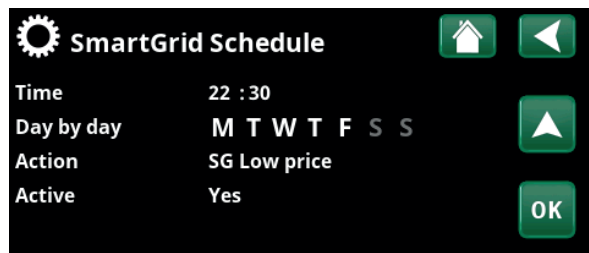

The schedule is set to start at 22:30, weekdays.

**Tariff HP**

(Off/ K22-K25/Channel 1A-7B /BMS DI0-7)

This function is used to block the heat pump during periods when the electricity rate is higher.

In the "Installer/Define/Remote Control" menu:

- specify an "Input" for the remote control function.

In the "Installer/Define/Heat Pump" menu:

- configure the normal mode for the external control signal (Normally Open (NO)/Normally Closed (NC)) in the "Tariff HP ext. config." row.

In the "Installer/Settings/Heat Pump" menu:

- set "Tariff HP" ("On").

For more information, refer to the "Heating Pump" section in the "Installer/Settings" chapter.

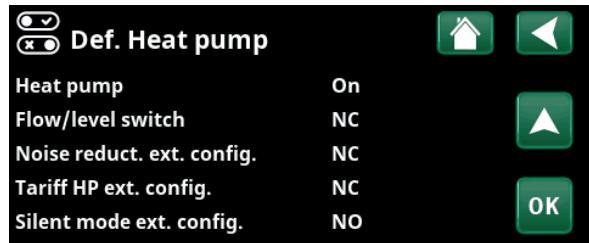

Menu: "Installer/Define/Heat Pump". A mode for the external control signal ("Normally Open (NO)" or "Normally Closed (NC)") is defined for "Tariff HP ext. config.", "Noise reduction ext. config." and "Silent mode ext. config.".



### Diff Thermostat function

(Off/K22-K25/Channel 1A-7B / BMS DI0-7)

This function is used to block the diff thermostat function.

In the "Installer/Define/Remote Control" menu:

- specify an "Input" for the remote control function.

In the "Installer/Define/Diff thermostat function" menu:

- configure the normal mode for the external control signal (Normally Open (NO)/Normally Closed (NC)) in the "Blocking diff thermostat ext. config." row.

For more information, refer to the "Diff thermostat function" section in the "Installer/Settings" chapter.

### HP Noise reduction

(Off/K22-K25/Channel 1A-7B / BMS DI0-7)

This function can be used to reduce compressor speed in order to reduce the noise level.

In the "Installer/Define/Remote Control" menu:

- specify an "Input" for the remote control function.

In the "Installer/Define/Heat Pump" menu:

- configure the normal mode for the external control signal (Normally Open (NO)/Normally Closed (NC)) in the "Noise reduction ext. config." row.

In the "Installer/Settings/Heat Pump" menu:

- in the "Ext. noise reduction RPS" row, set the compressor speed value applicable for remote control.

For more information, refer to the "Heating Pump" section in the "Installer/Settings" chapter.

### HP Night Mode

(Off/K22-K25/Channel 1A-7B / BMS DI0-7)

This function can be used to reduce compressor speed and fan speed in order to reduce the noise level.

Only applies to air-to-water heat pumps.

In the "Installer/Define/Remote Control" menu:

- specify an "Input" for the remote control function.

In the "Installer/Define/Heat Pump" menu:

- configure the normal mode for the external control signal (Normally Open (NO)/Normally Closed (NC)) in the "Silent mode ext. config." row.

For more information, refer to the "Heating Pump" section in the "Installer/Settings" chapter.

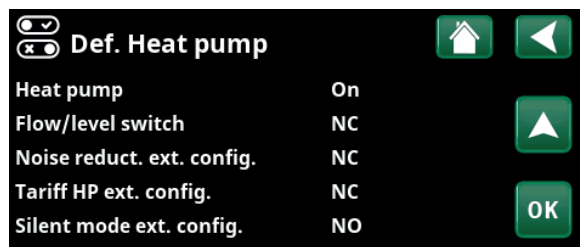

Menu: "Installer/Define/Heat Pump".

A mode for the external control signal ("Normally Open (NO)" or "Normally Closed (NC)") is defined for "Noise reduction ext. config.".

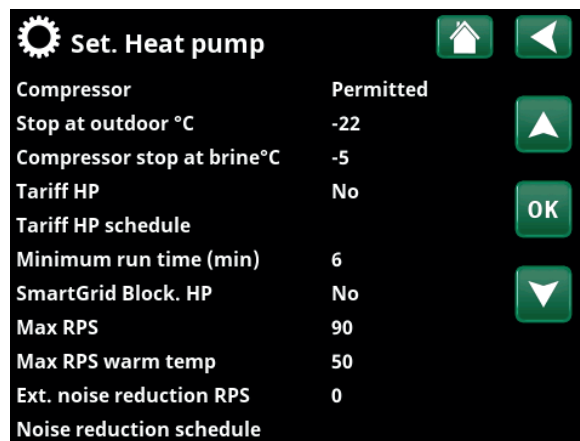

Menu: "Installer/Settings/Heat Pump".

Set the compressor speed value applicable for remote control in the "Ext. noise reduction RPS" row.



## 9.10.2 Def. Heating Circuit

**Heating Circuit 1** Yes (Yes/No)

Heating Circuit 1 (HC 1) is predefined by the control system. Heating Circuit 2 is shown on the row underneath if connected.

**Room sensor** Yes (Yes/No/Show)

Selection "Yes" means that room sensors should be connected to the heating circuit.

If "Show" is selected, the room temperature is displayed but the room sensor is not used for control.

**Type** Wireless (Cable/Wireless/SmartControl)

Select whether the room sensor for the heating circuit has a wired (via cable) or wireless connection.

- **Wireless**  
Select "Wireless" to connect CTC's wireless room sensors to the heating circuit. Refer to the "CTC Wireless Room Sensor" manual for information on how to connect these sensors.
- **SmartControl**  
SmartControl is a separate series of wireless accessories. If "SmartControl" is selected, the connection channel must be selected in the row below. SmartControl accessories are connected to the system via the "Installer/Define/SmartControl" menu. Refer to the separate SmartControl Accessories manual.

**HC1- Night reduction ext. config.** None (None/NO/NC)

This menu defines the Normally Open (NO) or Normally Closed (NC) mode for the external control signal when remotely controlling the function.

For examples of how to set the normal mode, refer to the "Installer/Define/Remote Control" chapter.

**HC1- Heating mode ext. config.** None (None/NO/NC)

This menu defines the Normally Open (NO) or Normally Closed (NC) mode for the external control signal when remotely controlling the function.

For examples of how to set the normal mode, refer to the "Installer/Define/Remote Control" chapter.

**Program \* ext. config.** None (None/NO/NC)  
**\*economy/normal/comfort/custom**

This menu defines the Normally Open (NO) or Normally Closed (NC) mode for the external control signal when remotely controlling the function.

For examples of how to set the normal mode, refer to the "Installer/Define/Remote Control" chapter.

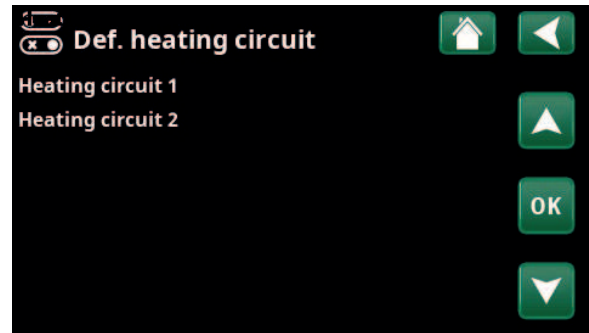

Menu: "Installer/Define/Heating Circuit".  
Select a heating circuit and press "OK" to access the settings.

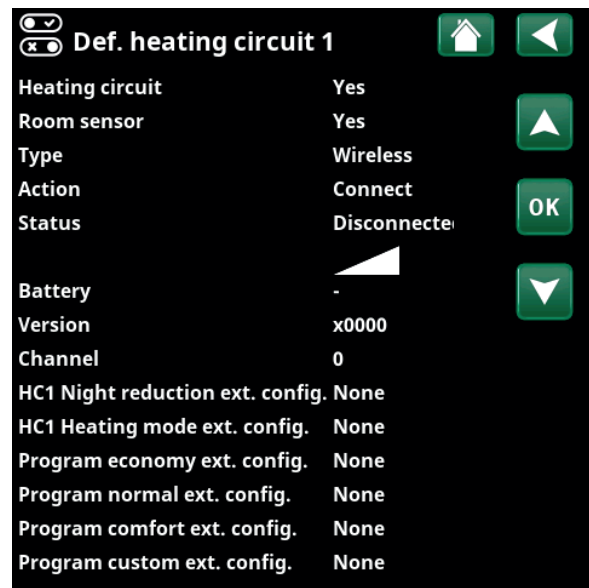

Menu: "Installer/Define/Heating Circuit/ Heating Circuit 1".  
Wireless room sensor selected.

### 9.10.3 Def. Heat pump

**Heat pump** Off (On/Off)

Select whether the heat pump should be On or Off.

**Flow/level switch** None (None/NC/NO)

This menu bar is displayed if an "Input" for remote control is defined for the "Flow/level switch" function in the "Installer/Define/Define Remote Control" menu.

**Noise reduct. ext. config.** None (None/NC/NO)

This menu bar is displayed if an "Input" for remote control is defined for the "HP Noise Reduction" function in the "Installer/Define/Remote Control" menu.

**Tariff HP ext. config.** None (None/NC/NO)

This menu bar is displayed if an "Input" for remote control is defined for the "HP Tariff" function in the "Installer/Define/Remote Control" menu.

**Silent mode ext. config.\*** None (None/NC/NO)

This menu bar is displayed if an "Input" for remote control is defined for the "Silent Mode" function in the "Installer/Define/Remote Control" menu.

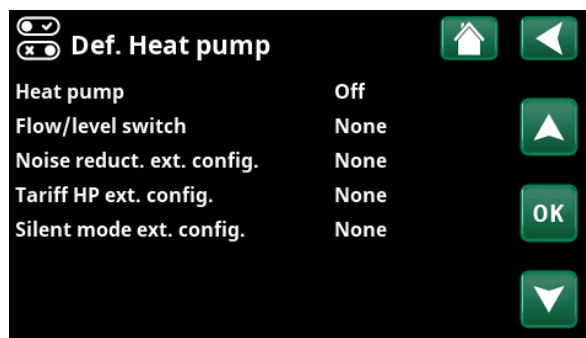

Menu: "Installer/Define/Heat Pump".

### 9.10.4 Def. Communication

**myUplink** No (Yes/No)

Select "Yes" to connect to the heat pump from the myUplink app.

**Web** No (Yes/No)

Select "Yes" to connect to the local web server. Internet router and firewall required.

**El.prices** myUplink/myUplink ext./BMS/No

Select "myUplink" to connect the heat pump to the myUplink mobile app for electricity price control.

Select "myUplink ext." to connect via myUplink to an external price control app. This option is not available at the moment.

Select "BMS" to connect via property management.



Menu: "Installer/Define/Communication".

**i** For more information, see the "Installation Communication" chapter of this manual.

### 9.10.5 Def. DHW

**Extra DHW ext. config.** None (None/NC/NO)

This menu defines the Normally Open (NO) or Normally Closed (NC) mode for the external control signal when remotely controlling the function.

For examples of normal mode settings, refer to the "Def. Remote Control" section of the "Installer/Define" chapter.



Menu: "Installer/Define/DHW" .

*\*Only applies to air-to-water heat pumps.*

### 9.10.6 Def. Diff thermostat

**Diff thermostat function** No/Yes

If "Yes" is selected, the menu "Blocking diff thermostat ext. config." is displayed.

**Blocking diff thermostat ext. config.** None  
(None/NC/NO)

This menu defines the Normally Open (NO) or Normally Closed (NC) mode for the external control signal when controlling the function remotely.

For examples of normal mode settings, refer to the "Def. Remote Control" section of the "Installer/Define" chapter.

Information about the Differential thermostat function is shown in chapter "Operation info".

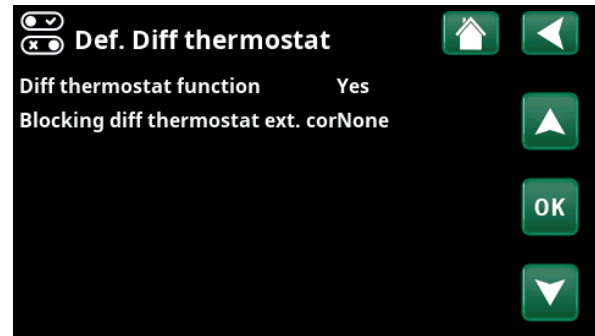

Menu: "Installer/Define/Diff thermostat".

### 9.10.7 Def. Immersion heater

**Tariff EL ext. config.** None (NO/NC/None)

The function can block the immersion heater at times of high electricity tariffs by means of an external signal.

This menu defines the Normally Open (NO) or Normally Closed (NC) mode for the external control signal when remotely controlling the function.

For examples of normal mode settings, refer to the "Def. Remote Control" section of the "Installer/Define" chapter.



Menu: "Installer/Define/Immersion heater".

## 9.10.8 Def. Cooling

Cooling is adjusted using primary flow sensor 2 (B2), which then means that heating circuit 2 and cooling cannot be used simultaneously.

**Cooling** **No (Passive/No)**

"Passive" means that cooling is used.

**Common Heating/Cooling** **No (Yes/No)**

"Yes" means that cooling and heating are distributed in the same heating circuit.

**Condense secured** **No (No/Yes)**

If the system is condensation-proofed, significantly lower temperatures are permitted at various points in the system. **WARNING!** Build-up of condensation in the house structure can lead to damp and damage from mildew.

"No" means a setting range for room temperature of 18-30 °C and "Yes" means a setting range of 10-30 °C.

In the event of doubt, contact a professional for an assessment.

**Room sensor** **Yes (Yes/No/Show)**

Selection "Yes" means that room sensors should be connected to the heating circuit.

If "Show" is selected, the room temperature is displayed but the room sensor is not used for control.

**Type** **Cable/Wireless/SmartControl**

Select whether the heating circuit room sensor is:

- **Cable**  
Wired room sensor.
- **Wireless**  
If "Wireless" is selected, CTC's wireless room sensors will connect to the heating circuit. Refer to the "CTC Wireless Room Sensor" manual for information on how to connect these sensors.
- **SmartControl**  
SmartControl is a separate series of wireless accessories. If "SmartControl" is selected, the connection channel must be selected in the row below. These accessories must be connected to the heating circuit via the "Installer/Define/SmartControl" menu. Refer to the separate "Installation and Maintenance Manual" for the SmartControl accessory.

**Block cooling ext. config.** **None (None/NC/NO)**

This menu bar is displayed if an "Input" for remote control is defined for the "Block Cooling" function in the "Installer/Define/Remote Control" menu.

The function can be used to turn off cooling with the help of a humidity sensor when there is a risk of condensation. This menu defines the Normally Open (NO) or Normally Closed (NC) mode for the external control signal when remotely controlling the function.

For examples of normal mode settings, refer to the "Def. Remote Control" section of the "Installer/Define" chapter.

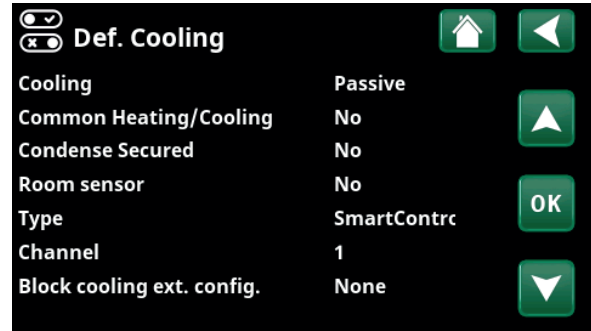

Menu: "Installer/Define/Cooling".



A room sensor must always be used in that part of the property which is to be cooled, as it is the room sensor which determines/controls cooling capacity.

### 9.10.9 Def. SMS

**Activate** **No (Yes/No)**

If "Yes" is selected, the menus below are displayed:

**Level of signal**

The signal strength of the reception is shown here.

**Phone Number 1**

The first activated phone number is shown here.

**Phone Number 2**

The second activated phone number is shown here.

**Hardware Version**

The hardware version of the SMS accessory is shown here.

**Software Version**

The software version of the SMS accessory is shown here.

**NB:** For more information about the SMS function, refer to the "Installation and Maintenance Manual" for CTC SMS.

### 9.10.10 Def. SmartControl

SmartControl is a separate series of wireless accessories.

**SmartControl** **No (Yes/No)**

If "Yes" is selected, SmartControl accessories can be connected to the heating circuit. Refer to the connection procedure in the separate SmartControl Accessories manual.

### 9.10.11 Def. Current sensor

**Current sensor** **Yes (Yes/No)**

Select "Yes" if current sensors are to be connected to the system.

For more information, refer to the "Current Sensors" section in the "Installer/Settings" chapter.

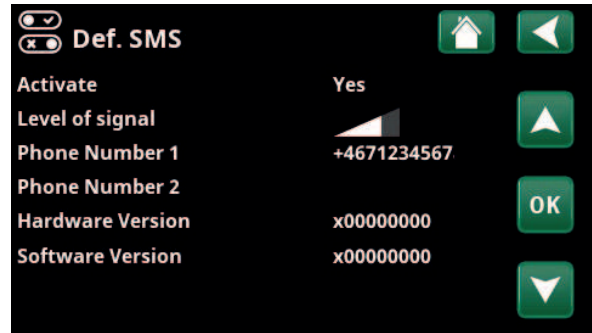

Menu: "Installer/Define/ SMS".

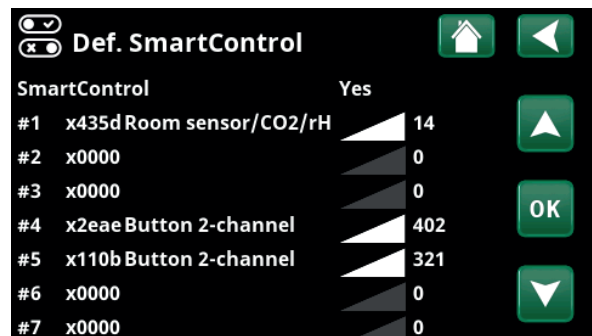

Menu: "Installer/Define/SmartControl".



## 9.11 Service



NB: This menu is intended for the installer only.

### 9.11.1 Function test

From this menu, the installer can test the connection and function of separate components of the heating circuit. When this menu is activated, all control functions are stopped. The only protection against incorrect operation is the pressure sensors and the immersion heaters overheating protection device. The heat pump returns to normal operation after 10 minutes of inactivity or when exiting the "Function Test" menu. When the menu is opened, all automatic functions are stopped and testing can be performed.



When you exit the menu, the heat pump returns to normal operation.

#### 9.11.1.1 Test Heating circuit

If several heating circuits have been installed, they will all be displayed here.

**Mixing valve (1-)** **Close (Close/Open)**  
Opens and closes the respective mixing valve.

**Rad pump (1-)** **Off (On/Off)**  
Starts and stops the respective radiator pump.

**LED room sensor** **Off (On/Off)**  
The room sensor alarm functions can be controlled from here. When activated, the respective room sensor's red LED comes on steady.

#### 9.11.1.2 Test Heat pump

**HP Compressor** **Off (On/Off)**  
When the compressor is being function tested, the brine and charge pump are also operating so that the compressor does not trigger its pressure switches.

**HP Brine pump/Fan** **Off (Off/On)**  
Function test brine pump or fan (air-to-water HP).

**HP Charge Pump** **Off (Off/On/ 0...100%)**  
Function test charge pump 0-100%.

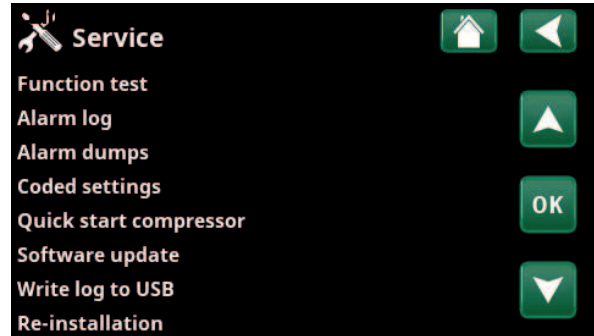

Menu: "Installer/Service".

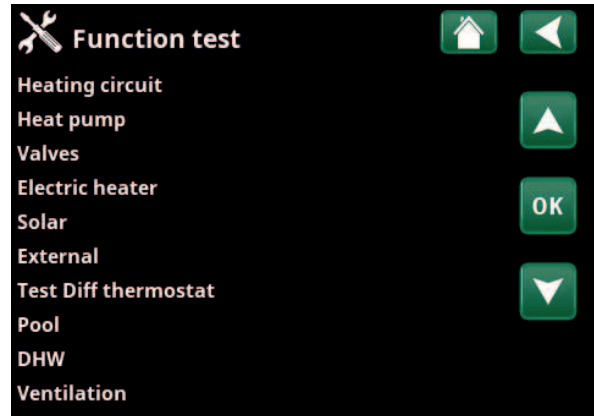

Menu: "Installer/Service/ Function Test".

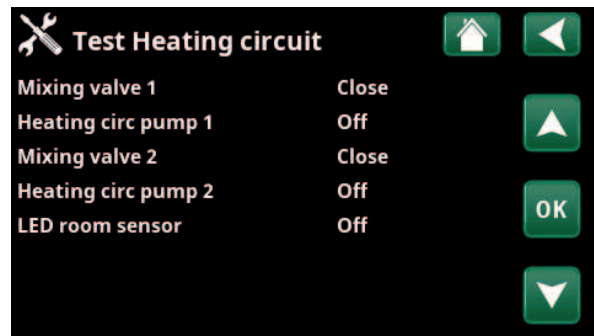

Menu: "Installer/Service/ Function Test/Heating Circuit".

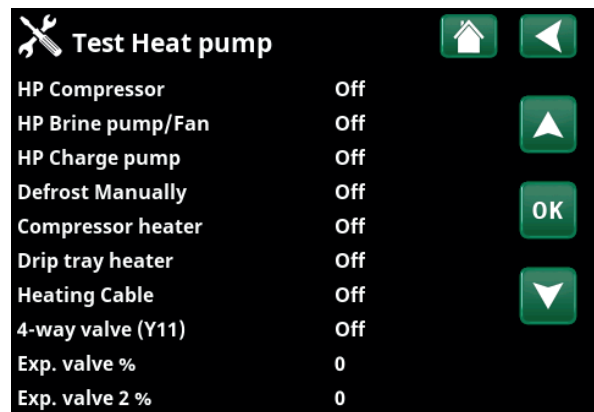

Menu: "Installer/Service/ Function Test/Heat Pump".

**Defrost Manually** **Off (Off/On)**

When the "Manual defrosting" function is tested, a defrosting cycle will be performed in the air-to-water heat pump. Defrosting cannot be stopped once it has been started and the defrosting programme will be completed.

**Compressor heater** **Off (Off/On)**

Function test compressor heater.

**Drip tray heater** **Off (Off/On)**

Function test of the condenser tray heater.

**Heating Cable** **Off (Off/On)**

Function test heating cable.

**4-way valve (Y11)** **Off (Off/On)**

Function test 4-way valve (Y11). Fitted to air-to-water HP.

**Exp. valve /2 %** **0 (0...100)**

Function test expansion valve. This menu bar is displayed depending on heat pump model.

### 9.11.1.3 Test Valves

The following valves are function tested from this menu:

**3-way valve** **Down (Up/Down)**

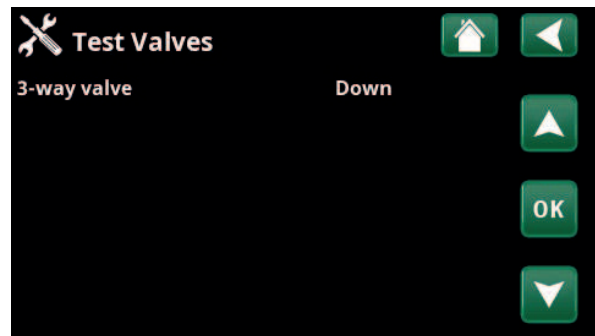

Menu: "Installer/Service/ Function Test/Valves".

### 9.11.1.4 Test Immersion heaters

Tests the immersion heaters per phase and step (on/off).

**Immersion heater L1A** **Off (Off/On)**

**Immersion heater L1B** **Off (Off/On)**

**Immersion heater L2A** **Off (Off/On)**

**Immersion heater L2B** **Off (Off/On)**

**Immersion heater L3A** **Off (Off/On)**

**Immersion heater L3B** **Off (Off/On)**

**Immersion heater A13** **Off (Off/On)**

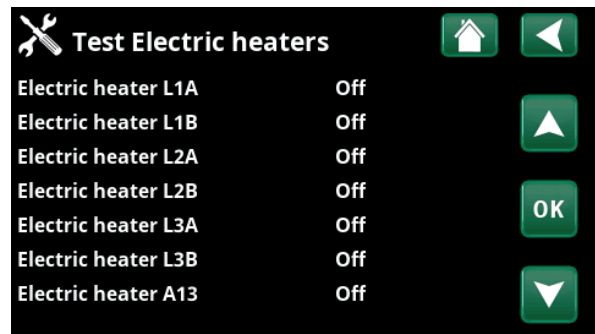

Menu: "Installer/Service/ Function Test/Immersion heaters".

### 9.11.1.5 Test Diff. thermostat

**Pump H-tank (G46)** **Off (Off/On)**

Function test of circulation pump to tank transfer.

#### Temperatures

This displays current temperatures.

• **H-tank (B6)** **67 °C**

• **Diff thermostat °C (B46)** **68 °C**

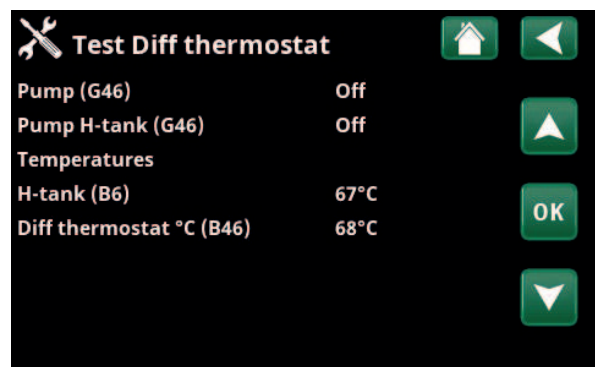

Menu: "Installer/Service/ Function Test/Diff Thermostat".

## 9.11.2 Alarm log

In the alarm log, up to 500 alarms can be displayed at the same time.

An alarm which reoccurs within an hour is ignored so as not to fill up the log.

Click an alarm row to see more information about an alarm.

If it is a "sensor alarm", a sensor value will be displayed at the bottom of the page from when the alarm was triggered for further troubleshooting.

For alarms related to the heat pump, values can be displayed from sensors for pressure (HP, LP), temperature (SH=Superheating) and current (I).

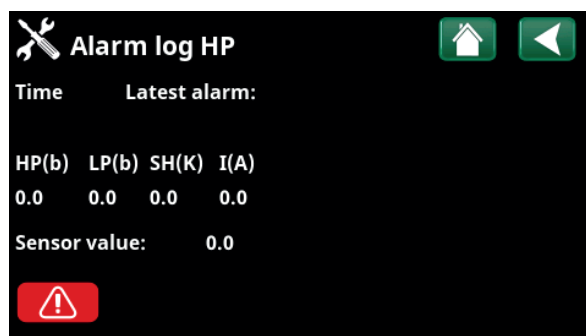

Menu: "Installer/Service/ Alarm log".

**!** NB: Only an authorised service engineer is allowed to log in to the Factory settings coded option. Severe operational problems and faults may occur affecting the product if values are amended without authorisation. Note that in such cases the warranty terms do not apply.

## 9.11.3 Alarm dumps

Export the alarms displayed in the alarm log to a USB drive. A dump can consist of one or more alarms as well as specific values before and after the alarm was triggered.

## 9.11.4 Coded settings

This menu is intended to set the manufacturer's operational and alarm limits. A 4-digit code must be specified to be able to amend these limits. However, you can also look without any code to see what options feature in the menu.

## 9.11.5 Quick start compressor

The delay normally prevents compressor start earlier than 10 mins after compressor stop. The delay is also activated in the event of a power failure, or the first time after production is started. This function speeds up this process.

For "System Types" 1 to 3, the degree minute loss is set to the value that starts all heat pumps.

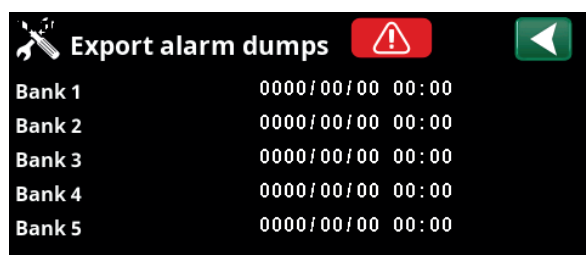

Menu: "Installer/Service/Alarm Dumps".

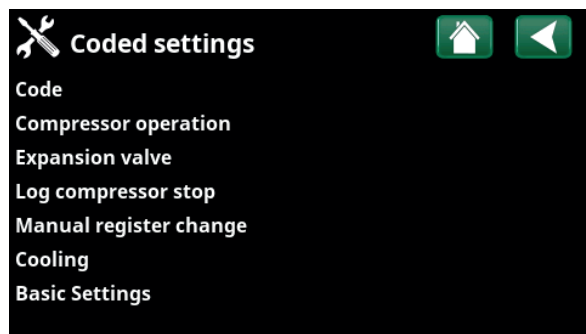

Menu: "Installer/Service/Coded settings".



### 9.11.6 Software update

The display software can be updated either via USB drive or online. The rows are greyed out until the USB drive is installed or the display is connected to the internet.

Click OK to confirm the upload.

The settings are retained during updating, but the old values are overwritten by any new factory values.

### 9.11.7 Write log to USB

Intended for service engineers. This function can be used to save logged values to a USB memory stick.

### 9.11.8 Re-installation

This command relaunches the installation sequence. First, confirm that you want to reinstall to access the installation wizard, refer to the "Installation Guide" and "First Start" chapters.

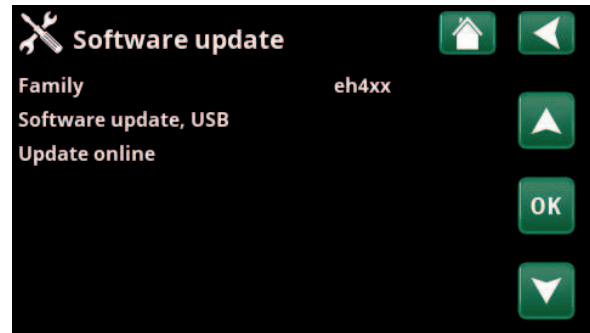

Menu: "Installer/Service/ Software Update".

**!** NB: The power to the product must not be interrupted, under any circumstances, during the update process.

**!** NB: Turn off the power and always restart the product after software update. Several minutes may pass before the display communicates clearly after restart.

## 10. Operation and Maintenance

When the installer has installed your new system, you should check along with the installer that it is in perfect operating condition. Let the installer show you where the switches, controls and fuses are so that you know how the system works and how it should be maintained. Bleed the heating circuit after around three days of operation and top up with water if required.

### Boiler and heating circuit safety valve

Check around four times a year that the valve is working by manually turning the control. Check that water is coming out of the safety valve discharge.

### Mixing valve

The mixing valve is operated automatically from the control system, so that the correct temperature, irrespective of the season, reaches the heating circuit. However, where a fault occurs, you can operate the valve by pulling out the knob on the motor and turning it clockwise to reduce the temperature or anticlockwise to increase it.

### Draining the tank

The heat pump must be disconnected from power when draining. The drain valve is located at the bottom left when viewed from the front, behind the front of the heat pump. When draining the whole system, the mixing valve should be fully open, i.e. turned anticlockwise as far as it will go. Air must be supplied to the closed system.

### Operation stop

The heat pump is shut down using the operating switch. If there is a risk of the water freezing, all the water should be drained from the boiler and the heating circuit (see drainage above).

The DHW circuit, which contains around five litres, must also be emptied. Disconnect the cold water connection on the heat pump and insert a hose. The hose must go down to the bottom of the coil for all the water to be drained. Draining is carried out by siphoning out the water.

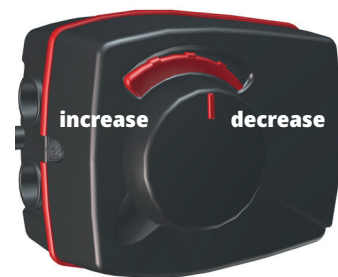

**i** Do not forget to reset the mixing valve to automatic mode by pushing in the knob again.

# 11. Troubleshooting

The heat pump is designed to provide reliable operation and high levels of comfort, and to have a long service life. Various tips are given below which may be helpful and guide you in the event of an operational malfunction.

If a fault occurs, you should always contact the installer who installed your unit. If the installer believes the malfunction is due to a materials or design fault, then they will contact CTC AB to check and rectify the issue. Always provide the product's serial number.

## DHW

Many people want to gain maximum benefit from the low operating costs of the heat pump. The control system is equipped with three comfort levels for DHW. We recommend starting at the lowest level and if there is not enough hot water, increase it to the next level. We also recommend that you operate a regular DHW pattern.

Check that the DHW temperature is not being affected by a poor mixing valve, whether at the heat pump or possibly the shower mixer.

## The heating circuit

A room sensor, which should be fitted when possible, ensures that the temperature in the room is always suitable and stable. For optimal running, radiator thermostats should always be fully open in the area where the room sensor is located.

A correctly operating heating circuit is important to the heat pump's operation and affects energy savings.

When adjusting the system, always do so with all radiator thermostats fully open. The thermostats can be individually adjusted after a few days in rooms where lower temperatures are desired.

### If you do not achieve the set room temperature, check:

- That the heating circuit is correctly adjusted and is functioning normally. That radiator thermostats are open and the radiators are equally warm all over. Touch the entire radiator surface. Bleed the heating circuit. The heat pump's economical operation requires that the heating circuit functions effectively.
- That the heat pump is in operation and no error messages are displayed.
- That there is enough electrical power available. Increase if necessary. Also check that the electric power output is not limited due to excessively high electricity loads in the property (load monitor).
- The product is set in "Max primary flow °C" mode with a too low set value.
- A sufficiently high value of "Max primary flow °C" has been selected at -15 °C outdoor temperature, increase if necessary. More can be read about this in the chapter on the "House heating curve". However, always check the other points first.
- That the temperature reduction is set correctly. See "Settings/Heating circuit".
- that the mixing valve is not in the manual position.

### If the heat is not even, check:

- That the placement of the room sensors is appropriate for the house.
- That the radiator thermostats don't interfere with the room sensor.
- That no other heat sources/cold sources interfere with the room sensor.
- that the mixing valve is not in the manual position.

● Avoid running DHW at the highest flow capacity. If you run a bath at a rather slower rate instead, you will get a higher temperature.

● Avoid placing the room sensor close to the stairway due to the uneven air circulation.

● If you do not have radiator thermostats on the upper floor, you may need to install them.

## Current monitor

The heat pump has an integrated current monitor. If the system is fitted with a current sensor, the property's main fuses are continuously monitored to ensure they are not overloaded. If the fuses are overloaded, the heat pump will automatically reduce its power output. The electrical output of the heat pump may be restricted where high heating requirement levels are combined with, for example, single-phase motor heaters, cookers, washing machines or tumble dryers. This may result in inadequate heating or DHW temperatures. If the heat pump is restricted, "High current, elpower reduced (X A)" appears in text form in the display. Consult an electrician to determine whether the fuse size is correct or the three phases in the house are evenly loaded.

## Air problems

If you hear a rasping sound from the tank, check that it has been properly bled. Turn the boiler vent valve so that any air can be evacuated. Top up with water where required, so that the correct pressure is achieved. If this noise recurs, call a technician to check the cause.

### Unusual noise when shutting off DHW

In some cases, unusual noises may be produced by the house's pipe system and the heat pump due to the pressure surges that occur when the flow is suddenly interrupted. There is no fault with the product, but the noise may occur when older types of instant closing mixers are used. More recent types are often fitted with a soft-closing mechanism. If an unusual sound comes from hard-closing dishwasher and washing machines, this can be remedied using a shock arrestor. A shock arrestor can also be an alternative to soft-closing water taps.

## Motor protection (when heat pump is connected)

The heat pump constantly monitors the compressor's operating current and an alarm is triggered if the compressor is using an unusually high current. When a fault occurs the message "Motor protect high current" is displayed.

### The cause of the fault may be as follows:

- Phase failure or mains interruption. Check the fuses, which are the most common cause.
- Compressor overload. Call out a service engineer.
- Faulty compressor. Call out a service engineer.
- Inadequate circulation between the heat pump and boiler. Check the heat medium pump (left pump, viewed from front). Call out a service engineer.
- Abnormally high temperature in the brine circuit. Call out a service engineer.

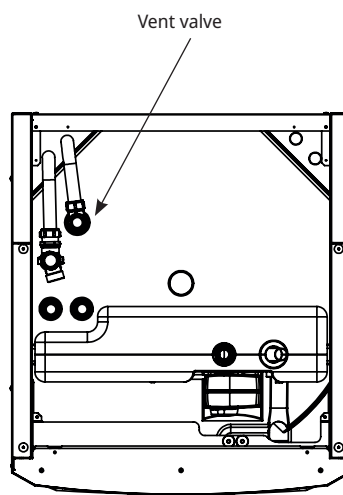

**i** Keep in mind that the heating circuit may also need bleeding.

## 11.1 Information messages

Information messages are displayed when appropriate and are intended to inform users about various operational situations.

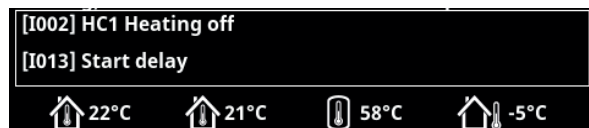

### **[I002] HC1 Heating off**

### **[I005] HC2 Heating off**

Shows for each heating circuit that the product is operating in summer mode when only DHW is required, not heating.

### **[I008] Tariff HP off**

Indicates that Tariff has switched off the heat pump.

### **[I009] Compressor blocked**

The compressor is set to be shut down, e.g. before drilling or digging has been carried out for the collector coils. The product comes with the compressor switched off. This option is selected in the "Installer/Settings/Heat Pump" menu.

### **[I010] Tariff EL Off**

Shows that tariff has switched off the immersion heater elements.

### **[I011] Round circulation**

Indicates that round circulation is active. Round circulation is a device which an electricity supplier can fit with the aim of disconnecting high current draw equipment for a short period of time. The compressor and electrical output are blocked when round circulation is active.

### **[I012] High curr., reduced elec.**

- The property's main fuses risk being overloaded due to, for example, the simultaneous use of several power-hungry appliances. The product reduces the electrical heaters' electrical output during this period.
- 2h max. 6 kW. Electric heating elements are limited to 6 kW for 2 hours after being switched on. This message appears if more than 6 kW are required during the product's first 2 hours of operation. This is applicable after a power outage or a new installation.

### **[I013] Start delay**

The compressor is not allowed to start too quickly when it has stopped. The delay is usually at least 10 minutes.

### **[I014] Drying period active, d**

Indicates that the floor function is active and displays the time (days) remaining that the function will be active.

### **[I017] SmartGrid: Blocking**

### **[I019] SmartGrid: Low price**

### **[I018] SmartGrid: Overcapacity**

The product is externally affected by "SmartGrid". See also "Define/Remote control/SmartGrid".

### **[I021] Ext. Ctrl Heating 1**

The remote control affects whether the heating is to be on or off. If the heating is switched off, "Heating off, heating circuit 1/2" is also displayed.

### **[I028] Holiday period**

Displayed when setting the holiday schedule, which entails lowering the room temperature and that no hot water is produced.

### **[I030] Driver block under voltage**

The heat pump has stopped due to insufficient mains voltage. The product will attempt to restart.

### **[I031] Driver block alarm**

The heat pump has stopped due to driver failure; for example, voltage or excessive temperature. The product will attempt to restart.

## 11.2 Alarm messages

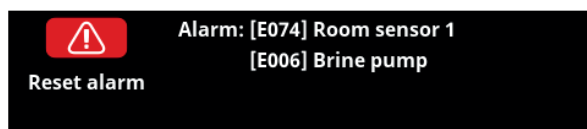

If a fault occurs with e.g. a sensor, an alarm is triggered. A message appears on the display with information about the fault.

You reset the alarm by pressing the Reset Alarm button on the display. If several alarms are triggered, they are displayed one after the other. A persisting fault must first be rectified before it can be reset. Some alarms are reset automatically if the fault ceases.

The description below also includes an alarm for connected heat pump.

Alarm messages	Description
<b>[E010] Compressor type?</b>	This message appears if no information about the compressor type is available.
<b>[E013] EVO off</b>	This message appears when there is a fault with the expansion valve control. Contact your installer.
<b>[E024] Fuse blown</b>	This message appears when the fuse (F1, F2) has blown.
<b>[E026] Heat pump</b>	This message appears if the heat pump is in alarm mode.
<b>[E035] High pressure switch</b>	The refrigerant's high pressure switch has been triggered. Press reset and check whether the alarm recurs. If the fault recurs, contact your installer.
<b>[E040] Low brine flow</b>	Low brine flow is often caused by air in the collector system, especially immediately following installation. Collectors which are too long can also be a cause. Also check that the brine pump is set to the fastest speed. Press reset and check whether the alarm recurs. Also check the brine filter that has been installed. If the fault recurs, contact your installer.
<b>[E041] Low brine temp</b>	Incoming brine temperatures from bore hole/ground loop are too low. Press reset and check whether the alarm recurs. If the fault recurs, contact your installer to check the dimensions of the cold side.
<b>[E044] Stop, high compr temp</b>	This message appears when the compressor temperature is high. Press reset and check whether the alarm recurs. If the fault recurs, contact your installer.
<b>[E045] Stop, Low evaporation</b>	This message appears when the evaporation temperature is low. Press reset and check whether the alarm recurs. If the fault recurs, contact your installer.
<b>[E046] Stop, high evaporation</b>	This message appears when the evaporation temperature is high. Press reset and check whether the alarm recurs. If the fault recurs, contact your installer.
<b>[E047] Stop, low suct. gas exp. valve</b>	This message appears when the suction gas temperature is low. Press reset and check whether the alarm recurs. If the fault recurs, contact your installer.
<b>[E048] Stop, low evap. exp. valve</b>	This message appears when the expansion valve's evaporation temperature is low. Press reset and check whether the alarm recurs. If the fault recurs, contact your installer.
<b>[E049] Stop, high evap. exp. valve</b>	This message appears when the expansion valve's evaporation temperature is high. Press reset and check whether the alarm recurs. If the fault recurs, contact your installer.
<b>[E050] Stop, low overheat. exp. valve</b>	This message appears when the expansion valve's overheat temperature is low. Press reset and check whether the alarm recurs. If the fault recurs, contact your installer.
<b>[E052] Phase 1 missing</b> <b>[E053] Phase 2 missing</b> <b>[E054] Phase 3 missing</b>	This message appears in the event of a phase failure.

Alarm messages	Description
<b>[E055] Incorrect phase sequence</b>	The product's compressor motor must rotate in the right direction. The product checks that the phases are connected correctly; otherwise, an alarm is triggered. This will require changing two of the phases into the product. The power supply to the system must be shut off when rectifying this fault. This fault generally only occurs during installation.
<b>[E057] Motor protect high curr.</b>	High current into the compressor has been detected. Press reset and check whether the alarm recurs. If the fault recurs, contact your installer.
<b>[E058] Motor protect low curr.</b>	Low current into the compressor has been detected. Press reset and check whether the alarm recurs. If the fault recurs, contact your installer.
<b>[E061] Max thermostat</b>	This alarm message appears if the product becomes too hot.  During installation, make sure the max. thermostat (F10) has not been triggered as there is a chance of this occurring if the boiler has been stored in extremely cold temperatures, Reset it by pressing in the button on the electrical switchboard behind the front panel.
<b>[E027] Comm. error HP</b>	This message is displayed when the display card (A1) cannot communicate with the HP control card (A5).
<b>[E063] Comm. err. relay board</b>	This message is displayed when the display card (A1) cannot communicate with the relay card (A2).
<b>[E021] Comm. err. motor protection</b>	This message is displayed when the HP control card (A5) cannot communicate with the motor protection (A4).
<b>[E086] Comm. err. expansion card</b>	This message is displayed when the display card (A1) cannot communicate with CTC Solar control/Expansion card (A3).
<b>[Exxx] 'sensor'</b>	An alarm message is displayed if an error occurs with a sensor that is not connected or has short-circuited and if the value is outside the sensor's range. If this sensor is important to the system's operation, the compressor stops. This requires the alarm to be reset manually after the fault has been rectified. For the following sensors, the alarm is reset automatically after correction: : [E003] Sensor brine in [E005] Sensor brine out [E028] Sensor VP in [E029] Sensor VP out [E030] Sensor outdoor (B15) [E031] Sensor primary flow 1 (B1) [E032] Sensor primary flow 2 (B2) [E036] Sensor high pressure [E037] Sensor discharge [E043] Sensor low pressure [E074] Sensor Room 1 (B11) [E075] Sensor Room 2 (B12) [E080] Sensor suction gas [E137] Sensor Diff thermostat (B46) [E138] Sensor EcoTank lower (B42) [E139] Sensor EcoTank upper (B41)
<b>[E057] Motor protect high curr.</b>	High current into the compressor has been detected. Press reset and check whether the alarm recurs. If the fault recurs, contact your installer.
<b>[E058] Motor protect low curr.</b>	Low current into the compressor has been detected. Press reset and check whether the alarm recurs. If the fault recurs, contact your installer.
<b>[E087] Driver</b>	Driver fault.
<b>[E088] Driver: 1 -</b> <b>[E109] Driver: 29</b>	Press reset and check whether the alarm recurs. If the fault recurs, contact your installer and tell them the error code number where applicable.
<b>[E117] Driver: Offline</b>	Communication error. Heat pump and driver not communicating.

Alarm messages	Description
<b>[E135] Risk of freezing</b>	Alarm indicating that the temperature of the outgoing water from the heat pump (HP out) is too low for defrosting. The water volume in the system may be too low. The flow may be too low. (Applies to EcoAir)
<b>[E152] 4-way valve</b>	This alarm message is displayed if a fault occurs with EcoAir's 4-way valve or if the connection pipes to the EcoAir are incorrectly connected. Press reset and check whether the alarm recurs. If the alarm recurs, check that the charge pump is pumping water to the heat pump's lower connection. If the fault recurs, contact your installer.
<b>[E163] Defrost max time duration</b>	The heat pump has not had time to complete defrosting within the maximum time. Make sure that any ice on the evaporator has disappeared.



## 11.3 Critical alarms - Risk of freezing



- [E135] Risk of freezing (after four alarms, a new alarm is displayed [E218])
- [E211] Risk of freezing low flow (after four alarms, a new alarm is displayed [E219])
- [E216] HP flow temp diff (after four alarms, a new alarm is displayed [E220])
- [E217] HP Charge pump flow (after four alarms, a new alarm is displayed [E221])

If a critical alarm is shown on the display, take the action described below. Confirm the alarm by entering code 4005 in the display menu "Installer/Service/Coded settings/Code".

Please note: The critical alarms can be acknowledged three times by entering code 4005. **After four alarms, the heat pump is blocked**; in this case, contact the installer. After one year of operation without any alarms, the critical alarms are reset.

### [E135] Risk of freezing

Applies to all air/water heat pumps controlled by CTC EcoLogic L/M/S, CTC EcoZenith i255/i360/i555 and CTC EcoVent i360F.

#### Alarm conditions

If the temperature of the water exiting the heat pump (HP out) is lower than 15 °C during a defrost period or if there is more than 15 °C difference between HP in and HP out for more than 20 seconds.

#### Possible cause

- The circuit temperature and/or flow rate is too low.
- If the sensors (HP in and HP out) do not display the correct value, alarm [E135] can be generated. Check the temperatures using an external thermometer.

#### Action

- Ensure that the return flow of the heating circuit is at a minimum of 25°C during a defrost period. In the event of low temperature, contact the installer.
- Supplement with a volume tank.
- Check the circulation pump, dirt filter, pipe system and pipe size to ensure flow requirements are met.
- Check the sensors (HP in and HP out) and replace as required.

### [E211] Risk of freezing low flow

Applies to CTC EcoAir 600M with the "Flow Sensor" accessory installed, and EcoAir 700M.

#### Alarm conditions

The flow is less than 10 l/min (EcoAir 610M/614M/708M/712M) or 15 l/min (EcoAir 622) for more than 30 seconds during a defrost period.

#### Possible cause

- The circuit temperature and/or flow rate is too low.

#### Action

- Check the circulation pump, dirt filter, pipe system, pipe size and flow sensor to ensure flow requirements are met.

! The critical alarms [E135], [E211], [E216] and [E217] can be acknowledged three times by entering code 4005. After four alarms, the heat pump is blocked.

### **[E216] HP flow temp diff**

Applies to CTC EcoAir 500/600M/700M.

#### **Alarm conditions**

The difference between HP in and HP out exceeds 12 °C in heat operation for more than 15 minutes.

#### **Possible cause**

- The circuit temperature and/or flow rate is too low.

#### **Action**

- Check the dirt filter, pipe system and speed settings of the circulation pump to ensure flow requirements are met.
- Check the sensors (HP in and HP out) and replace as required.

### **[E217] HP Charge pump flow**

Applies to CTC EcoAir 400.

#### **Alarm conditions**

The charge pump speed exceeds 70% during heat operation for more than 15 minutes.

#### **Possible cause**

- The circuit temperature and/or flow rate is too low.

#### **Action**

- Check the dirt filter, pipe system and speed settings of the circulation pump to ensure flow requirements are met.

## 12. Pipe installation

The installation must be carried out in accordance with the applicable standards. **Do not forget to flush the heating circuit clean before connecting.** Apply all the installation settings based on the description in the section entitled "First start".

### 12.1 Filling

Filling valve (no. 90, see schematic diagram on next page) is connected to the radiator return pipe. Alternatively, the valve can be installed in the direction of the expansion pipe. When the boiler and system are being filled with water, the mixing valve (Y1) must be fully open. Pull out the knob on the valve and turn it anticlockwise as far as you can. Do not forget to push and set the knob on the valve to automatic mode after filling. If the heat pump is not connected, connections 1 and 2 must be capped when filling with water. (See figure).

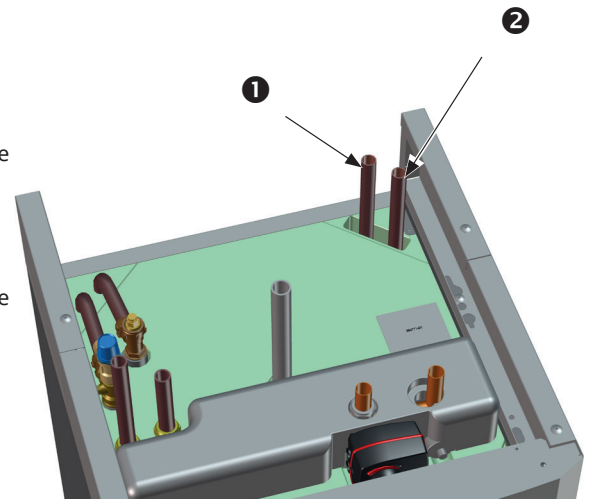

#### 12.1.1 Pressure drop in mixing valve

The diagram below shows a drop in pressure in the mixing valve.

Start with the heat requirement in kW (e.g. 15 kW) and move vertically to the selected  $\Delta t$  (e.g. 10 °C). Then move horizontally to the line for the EcoZenith i255 mixing valve = line 6.3 DN20. The reading for the pressure drop is taken from the scale directly below (4 kPa).

For EcoZenith i255, see valve DN20.

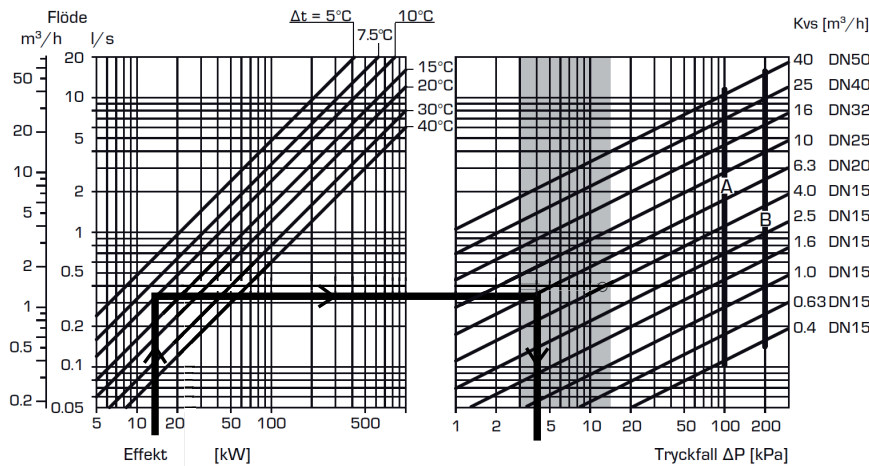

### 12.1.2 Pump curve charge pump 15-75 130

The diagram below shows the pump curve for the factory-installed charge pump for the heat pump. 15-75 130

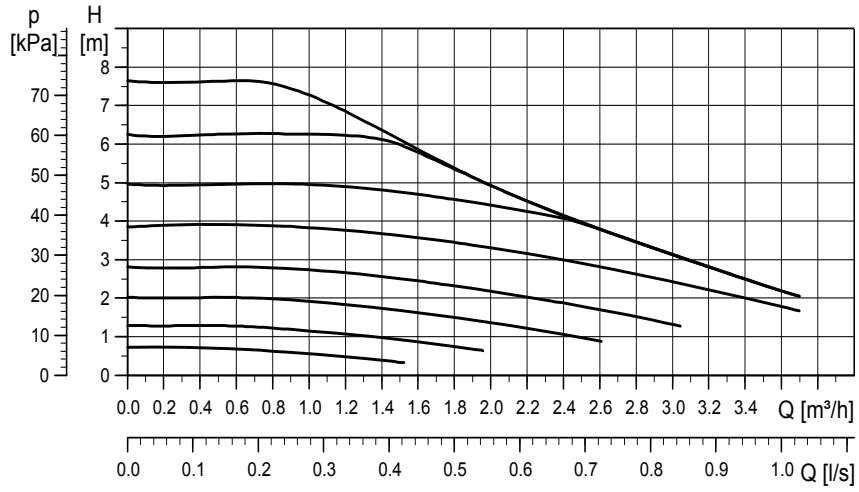

## 12.2 Schematic diagram

This shows the main connection between the CTC EcoZenith i255 and the property's heating circuit and DHW system. Different installations and systems may look different, e.g. a one or two-pipe system, which means that the finished installation may be different.

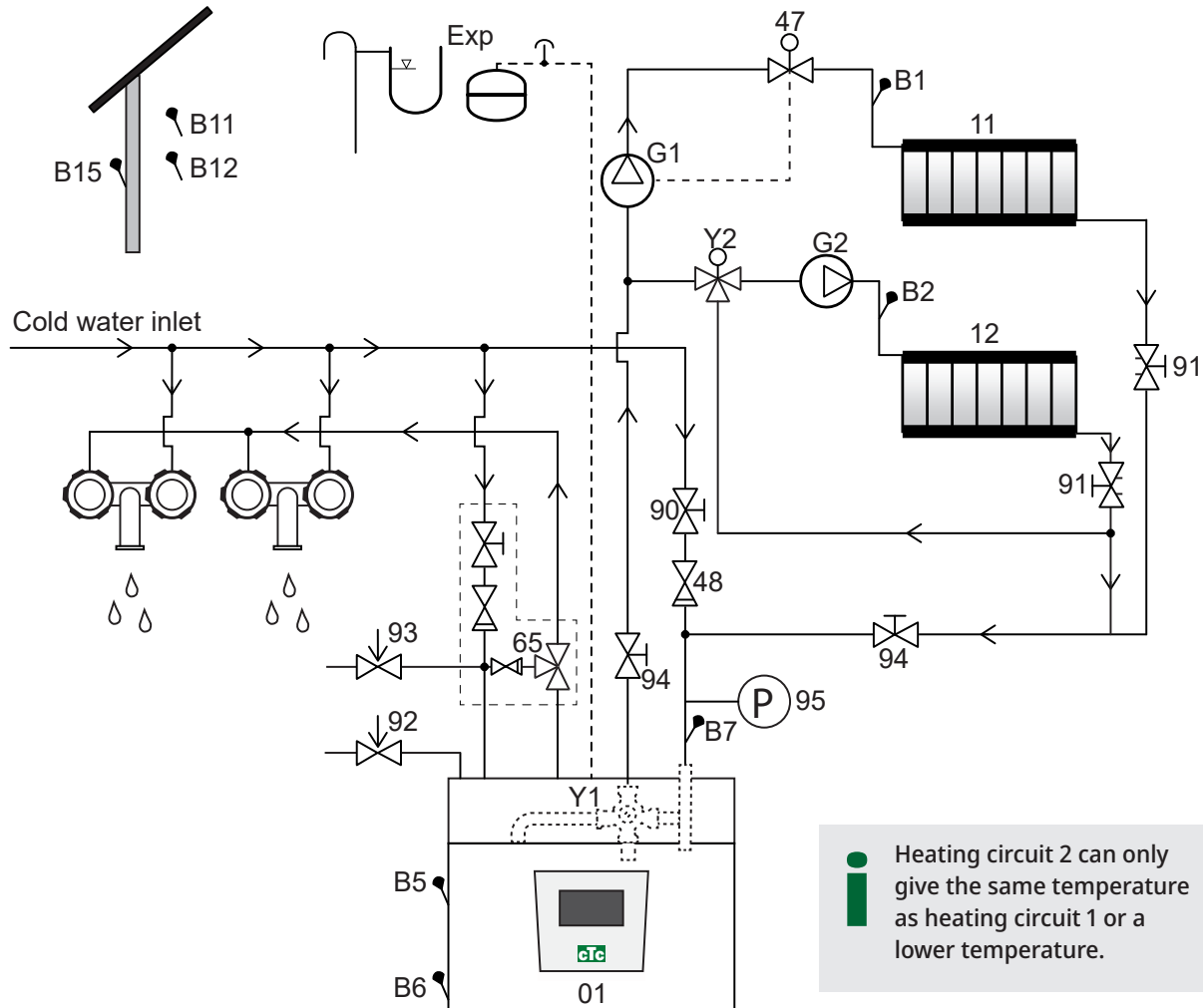

**i** Heating circuit 2 can only give the same temperature as heating circuit 1 or a lower temperature.

01	CTC EcoZenith i255	Y2	Mixing valve, heating circuit 2
B1	Primary flow sensor, heating circuit 1	11	Heating circuit 1
B2	Primary flow sensor, heating circuit 2	12	Heating circuit 2
B5	Sensor upper tank	47	Electric shut-off valve, heating circuit
B6	Sensor lower tank	48	Non-return valve for incoming cold water
B7	Sensor, radiator return	65	Mixing valve for DHW
B11	Room sensor 1	90	Filling valve, heating circuit
B12	Room sensor 2	91	Adjustment valves for heating coils
B15	Outdoor sensor	92	Boiler safety valve (factory-installed), 2.5 bar
G1	Circulation pump, heating circuit 1	93	Safety valve for DHW
G2	Circulation pump, heating circuit 2	94	Shut-off valve
Y1	Mixing valve, bivalent heating circuit	95	System/boiler pressure installed on return pipe

## Circulation pump, heating circuit (G1) (G2)

The circulation pump is fitted on the boiler's primary flow and must be connected electrically from the boiler; see chapter on Electrical installation.

## Mixing valve DHW (65)

Install a mixing valve for the hot tap water in order to avoid the risk of scalding.

## Safety valve for DHW out temp (93)

Fit the enclosed valve to the incoming cold-water connection. Connect the waste pipe to the waste system directly to the floor drain or, if the distance is more than two metres, to a funnel. The waste pipe must slope towards the waste system, be installed frost-free and left open to the atmosphere/without pressure.

## Non-return valve (48)

Fit the non-return valve to the incoming cold-water connection.

## Shut-off valve (94)

It is important to fit a shut-off valve (94) to both the primary flow and return flow.

## Boiler safety valve (92)

The boiler's safety valve (2.5 bar) is fitted in the factory on the left side of the top. Connect the waste pipe to the waste system directly to the floor drain or, if the distance is more than two metres, to a funnel. The waste pipe must slope towards the waste system, be installed frost-free and left open to the atmosphere/without pressure.

## Filling valve, heating circuit (90)

Fit a filling valve between the cold-water connection and the radiator return pipe, or between the cold-water pipe and the expansion pipe.

Observe local regulations and building regulations regarding backflow protection and standards (EN 1717).

## Manometer – system pressure (95)

Fit the manometer on the expansion pipe or radiator return pipe.

## Electric shut-off valve (47)

If the sub-mixing valve (heating circuit 2) is to operate in the summertime while heating circuit 1 is switched off, the system can be supplemented with an electric shut-off valve that closes the flow through the switching off of radiator pump (G1).

 NB: It is important to fit a shut-off valve (94) to both the primary flow and return flow.

 NB: The waste pipe must be fitted to the waste system.

## Expansion vessel

Expansion vessel is factory mounted (in the area under the tank) on the CTC EcoZenith i255, also available as an accessory with installation kit.

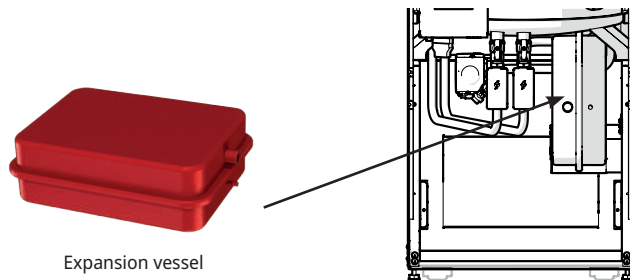

If you connect the product to an open system, the distance between the expansion vessel and the highest placed radiator must not be less than 2.5 m in order to avoid introducing oxygen into the system.

**Note** that hot water circulation must not be connected as it affects the function of the EcoZenith and the system. If EcoZenith i255 is connected to another heat source, e.g. an existing boiler, the systems must have separate expansion vessels.

The pre-pressure in the expansion vessel is calculated according to the height (H) between the highest-positioned radiator and the expansion vessel. The pre-pressure must be checked/set before the system is filled with water. The system pressure must be set 0.3 bar higher than the pre-pressure in the expansion vessel. For example, a pre-pressure of 1.0 bar (10 mvp) means a maximum permitted height difference of 8 m.

Maximum height (H) (m)	Pre-pressure (bar)	Maximum volume in the heating circuit (excluding product) (L)
3	0.5	240
8	1.0	85

**!** The expansion vessel is pre-pressurised to approx. 1 bar, and therefore needs to be adjusted to a suitable pre-pressure for the building. This must be done before the system is filled with water.

**●** If an open expansion vessel is used, the distance between the expansion vessel and the highest radiator should not be less than 2.5 m to avoid the system being oxygenated.

If a heat pump is connected with another heat source, e.g. an existing boiler, the installations must have separate expansion vessels.

**!** NB: If the heat pump is not connected, the connections not being used must be capped off!

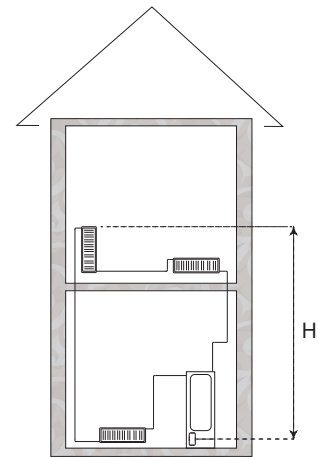

## Water taps

In some cases, unusual noises may be produced by the house's pipe system and the EcoZenith i255 due to the pressure surges that occur when the flow is suddenly interrupted. There is no fault with the product, but the noise may occur when older types of instant closing mixers are used. More recent types are often fitted with a soft-closing mechanism. Alternatively, a shock arrestor can be fitted. Keeping the jolting to a minimum also helps avoid unnecessary wear and tear affecting the DHW system.

### DHW circulation system

It is possible to connect a DHW circulation system, an example of such a connection is shown below.

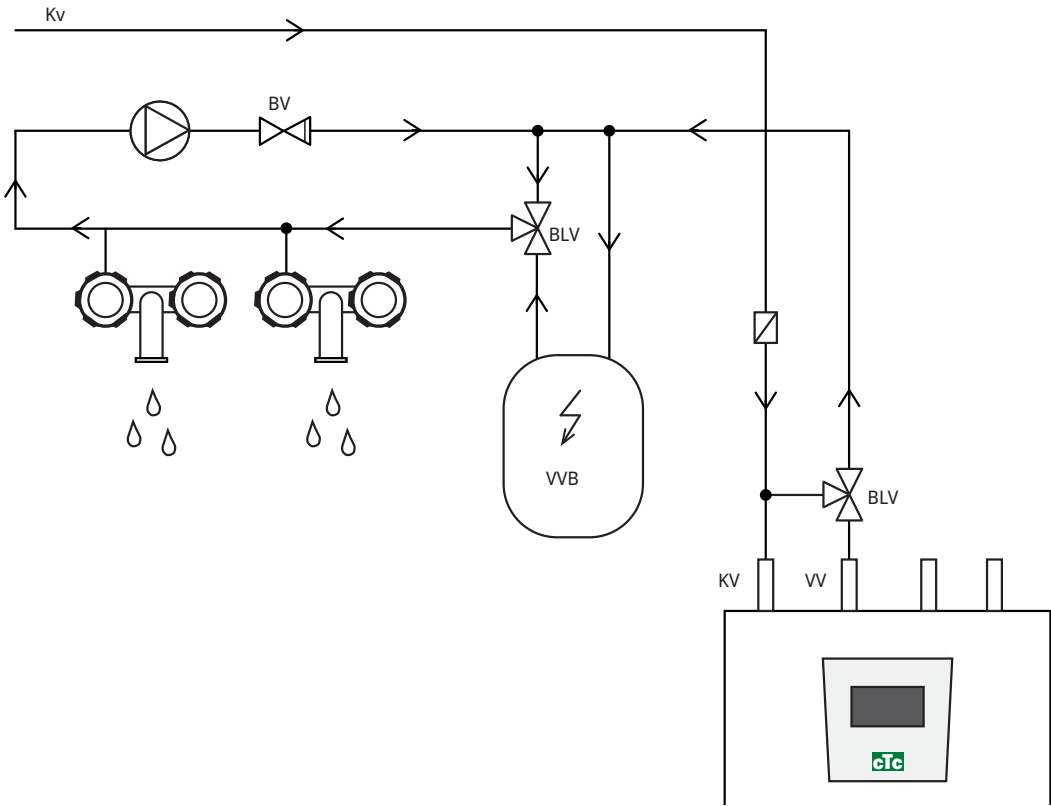

(\*G40 Not controlled by the product. Use a separate control or constant voltage on the circulation pump).



## 12.3 Connection to heat pump

The heat pump is connected to the top (CTC EcoZenith i255L, see figure below) or bottom (CTC EcoZenith i255H, see figure on following page).

### Pipe connection for CTC EcoZenith i255 L

In CTC EcoZenith i255 L, the charge pump for the heat pump is factory-fitted.

CTC EcoZenith i255 L has pipes on the rear of the right edge for connecting the heat pump.

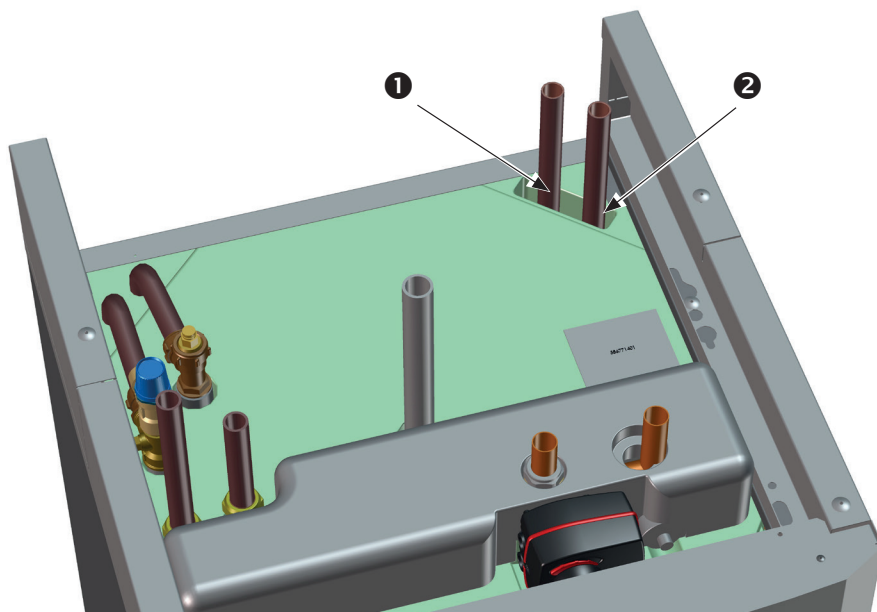

1. Incoming (heated water) from heat pump.
2. Outgoing (cold water) to heat pump.

## Pipe connection for CTC EcoZenith i255 H

On CTC EcoZenith i255H, the heat pump is connected directly to the supplied charge pump (3) located under the tank.

1. Incoming (heated water) from heat pump Ø22.
2. Outgoing (cold water) to heat pump, union 3/4.
3. The charge pump on CTC EcoZenith i255 H is fitted to the outgoing connection to the heat pump (behind the 3-way valves). The drainage valve must be fitted to this connection. It functions as drainage for both the boiler and the heating circuit.

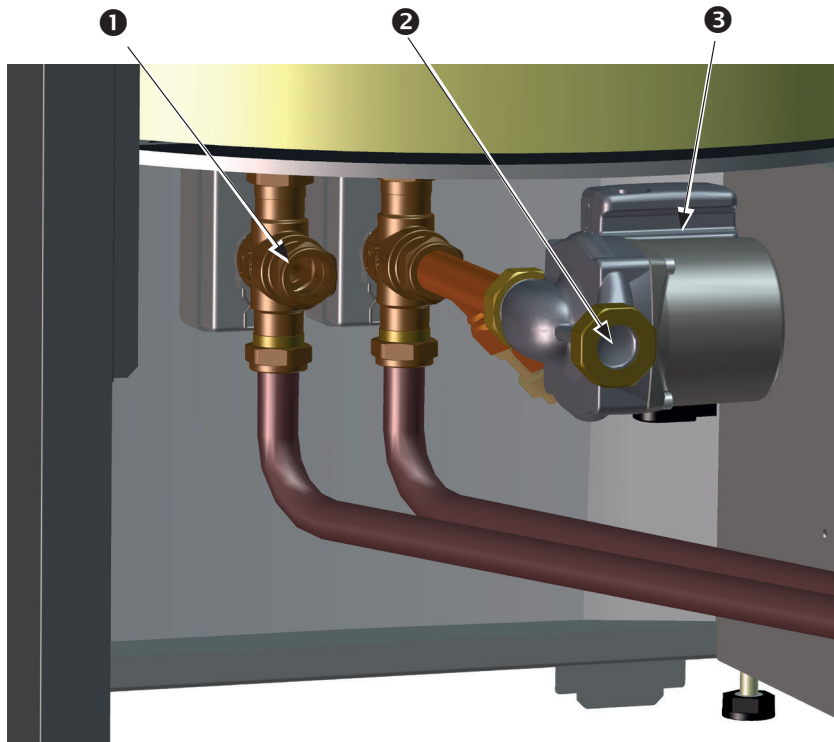

(NB! The picture shows the back of the product).

12.4 Schematic diagram of passive cooling - Combined cooling/heating

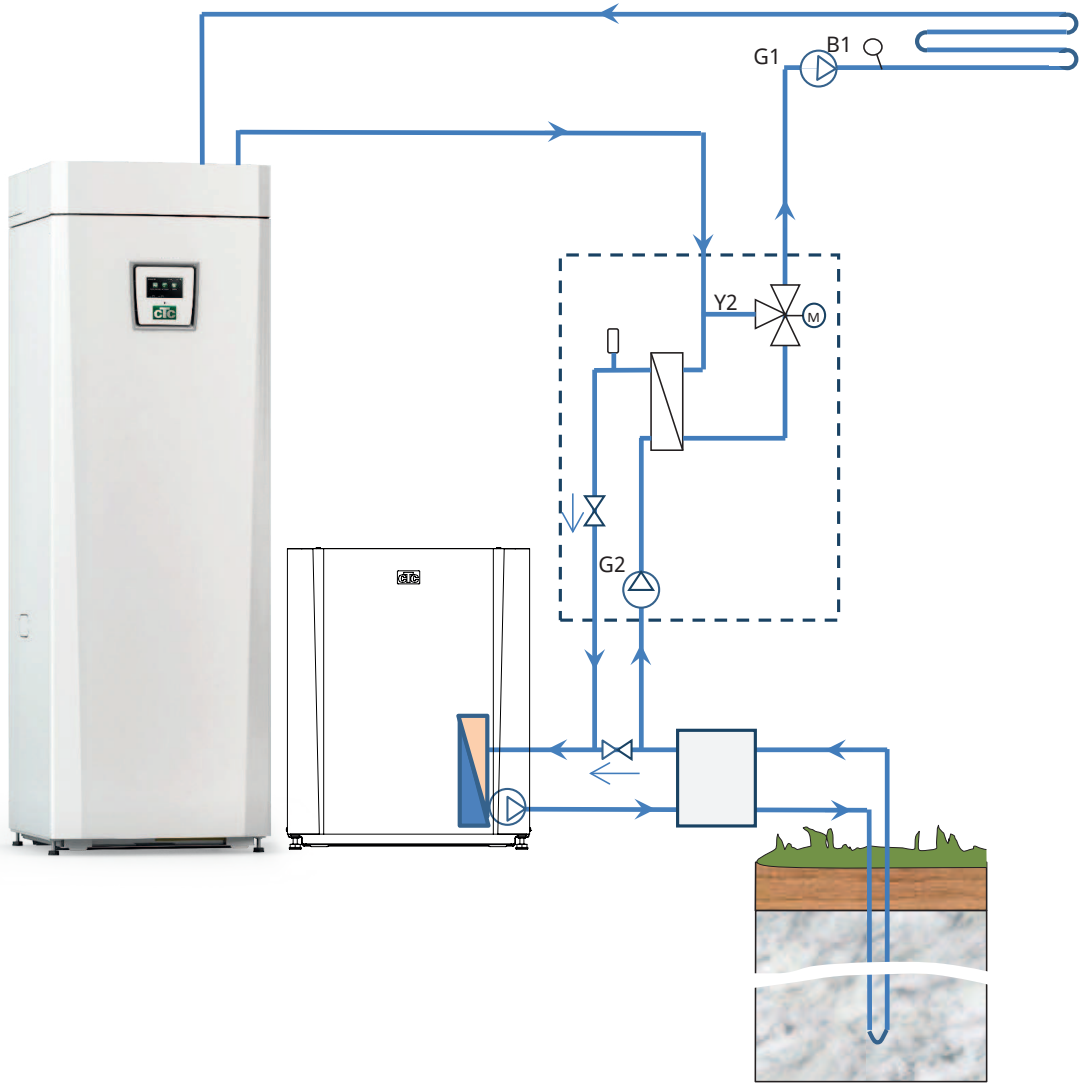

12.5 Schematic diagram of passive cooling in separate heating circuits.

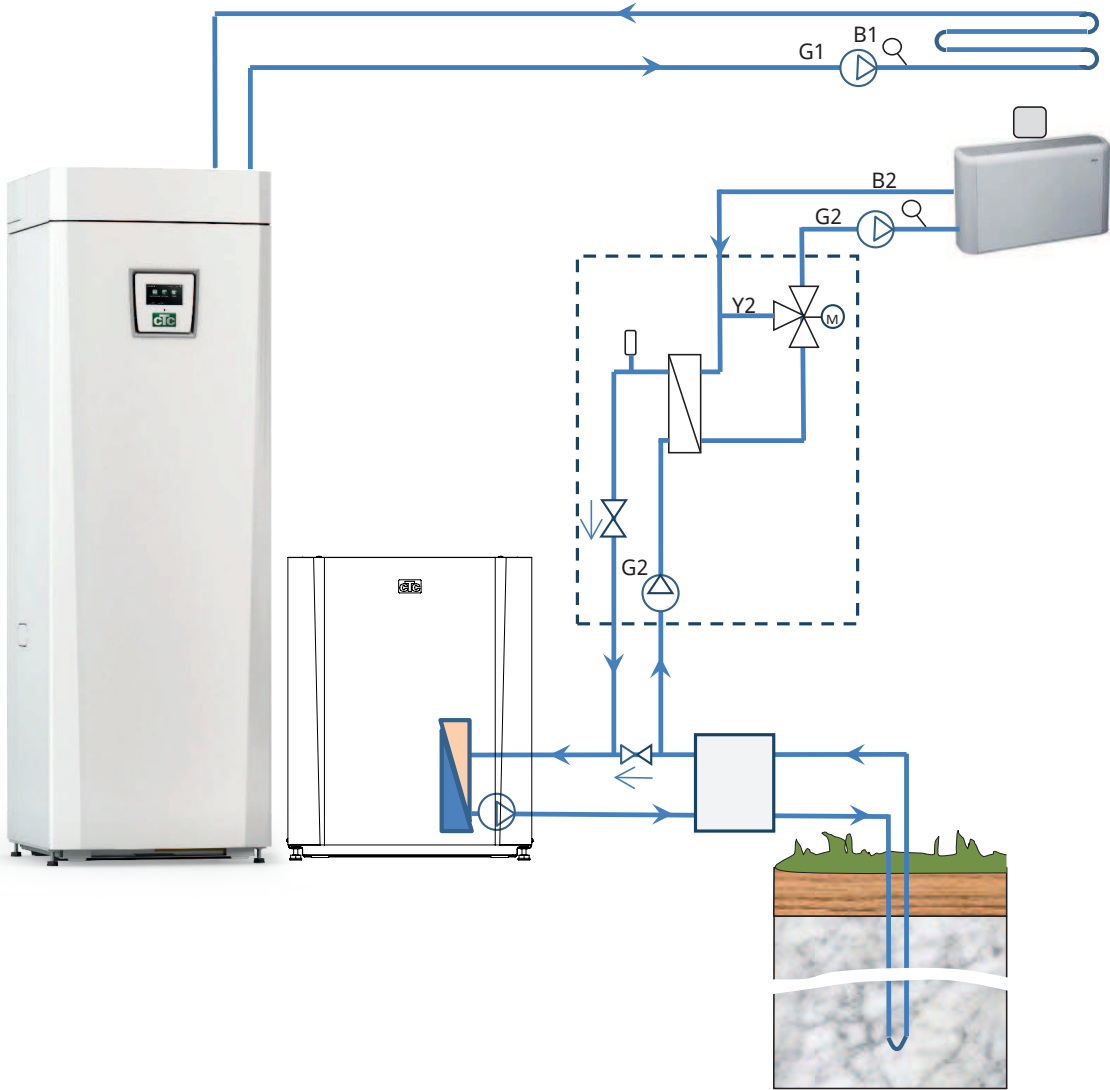

### 12.5.1 Diff thermostat function

The diff thermostat function is used to transfer heat from the tank with sensor (B46) to the H-tank.

The function compares temperatures in the tanks and when it is warmer in the tank (B46), charging to the H-tank is started.

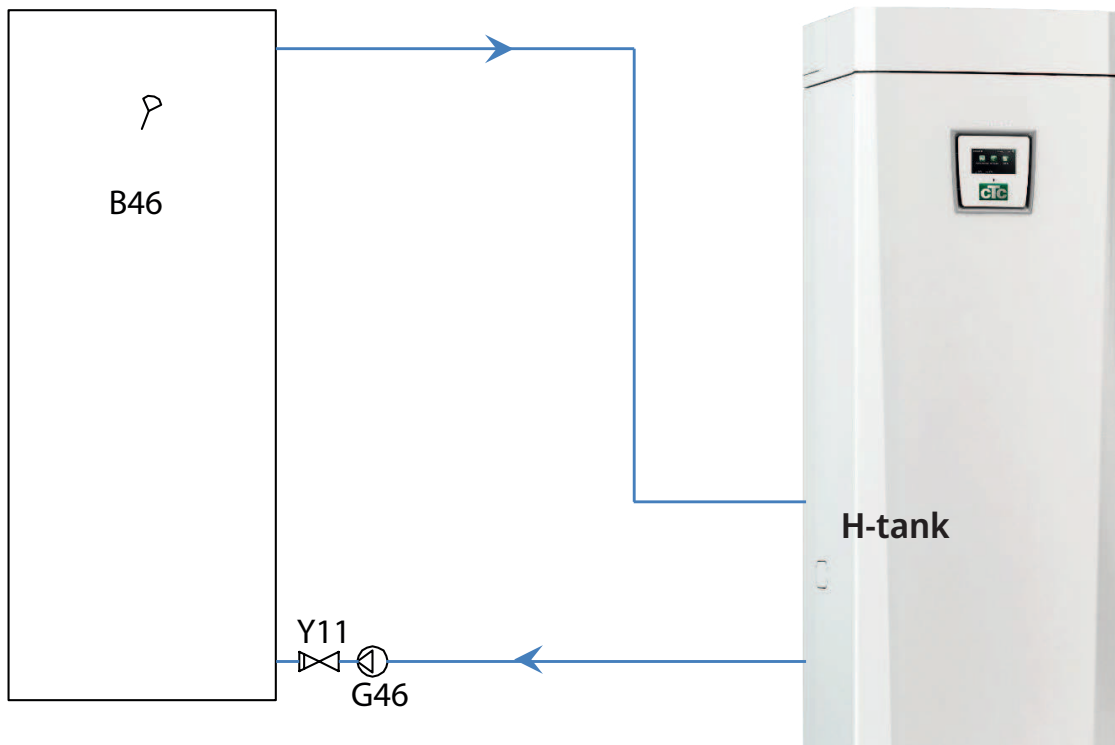

## 13. Electrical installation

Installation and connection in the CTC EcoZenith i255 must be undertaken by an authorised electrician. All wiring must be installed according to applicable provisions.

### Safety switch

The installation should be preceded by an omnipolar safety switch according to overvoltage category III, which ensures disconnection from all electric power sources.

### Residual current device

If there is already a residual current device for the building, the product still needs to be fitted with its own residual current device.

### Connecting the circulation pump, heating circuit

The radiator pump is connected electrically to the terminal board.  
Electrical data: 230V 1N~. Internal fuse 10A.

### Max thermostat

If the heat pump has been stored in an extremely cold place, the max thermostat may have been triggered. Reset it by pressing in the button on the electrical switchboard behind the front panel.  
Always check on installation that the max thermostat has not tripped.

### 13.1 Electrical installation

The 400V 3N~ product must be connected to 400V 3N~ 50Hz and protective earth.

The 230V 1N~ product must be connected to 230V 1N~ 50Hz and protective earth.

The 230V 3~ product must be connected to 230V 3~ 50Hz and protective earth.

The power supply cable is connected at (1), length 3 m supply cable, of which 1.1 m is inside the product. The minimum group fuse size is specified in "Technical data".

Symbol for max thermostat.

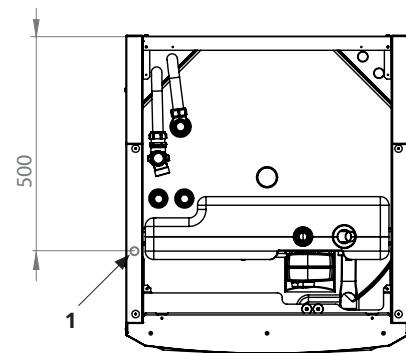

## 13.2 Positioning of electrical components

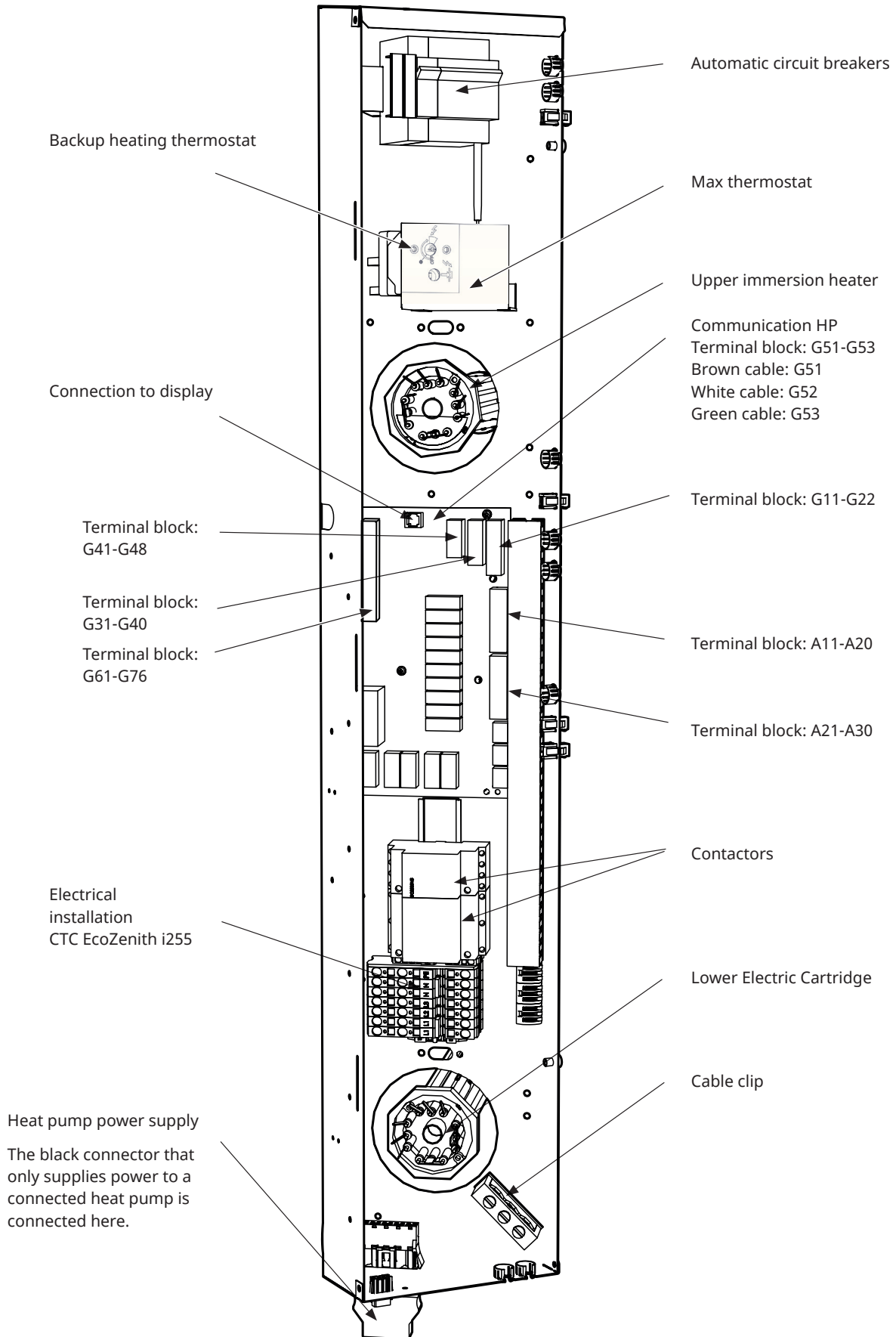

## 13.3 Electrical connection to heat pump

### General

The heat pump is powered from the CTC EcoZenith i255 via a separate connector. NOTE: does not apply to the CTC EcoAir 614M, 622M and 700M series, these products are powered separately.

### Charge pump

The factory-installed charge pump for heat pumps is connected internally in the CTC EcoZenith i255 L.

The charge pump is connected to CTC EcoZenith i255 H in the pre-assembled connector (Molex and PWM) located under the electrical cabinet.

### When working on the heat pump

Before starting any work on the heat pump the safety switch installed in front of the CTC EcoZenith i255 should be activated.

#### 13.3.1 Communication

Compatible heat pumps are controlled from CTC EcoZenith i255. Other makes of heat pump cannot be controlled from the EcoZenith. Communication between the products takes place via an LiYCY (TP) communication cable, which is a 4-conductor shielded cable, where the communication-bearing conductors are of twisted pair type. The connection is made in the communication port on the PCB and in the heat pump in accordance with its instruction manual.

**G51 = Brown cable, G52 = white cable, G53 = green cable**

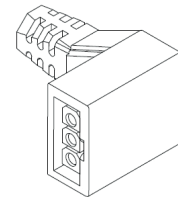

Charge pump Molex switch

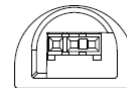

Charge pump PWM switch

#### CTC EcoAir

Grey communication connector.

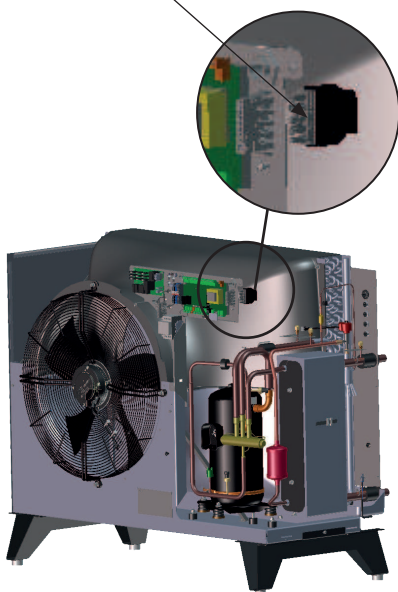

#### CTC EcoPart

Communication terminal block.

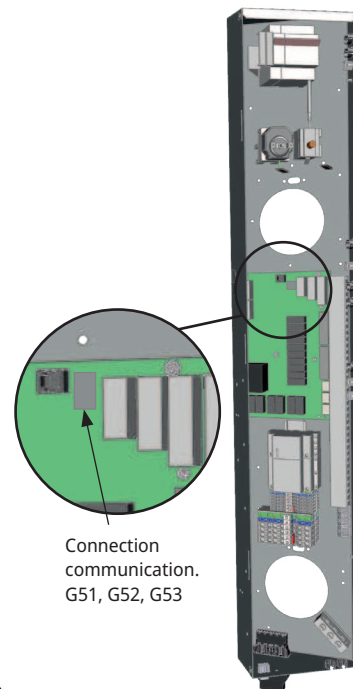
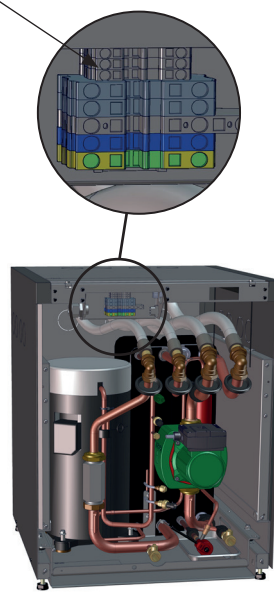

Connection communication.  
G51, G52, G53

EcoZenith connection box



### 13.3.2 Heat pump power supply

The heat pump can be powered from CTC EcoZenith i255 with the included black connector located at the bottom of the electrical box.  
(NOTE: does not apply to the CTC EcoAir 614M, 622M and 700M series, these products are powered separately. Control cabling only between the products.)  
The minimum group fuse size is specified in "Technical data".  
Factory-fitted cable from the heat pump is used for connection. Refer to the "Installation and Maintenance Manual".

#### Connecting the heat pump connector

- We recommend pulling the cable through the cable clip before you connect the wires. The cable clip can also be fitted afterwards. (See figure 1)
  - a. Outer sleeve stripped to 55 mm.
  - b. Wires stripped to 9 mm.
  - c. Advanced protective earth wires stripped to 7 mm.
- Open the terminal block by pushing a screwdriver (blade width 2.5 mm) into the block. Connect the stripped wires in the specified positions. Check that only the stripped parts are clamped to the terminals, **NO INSULATION!** (See figures 2 and 3).
- Fix the cable clip to the connector. The word **TOP** should be visible on both the terminal and the cable clip. (See figure 4).

Push the cable clip onto the connector. Then tighten the screw to obtain the desired tension. (See figure 5).

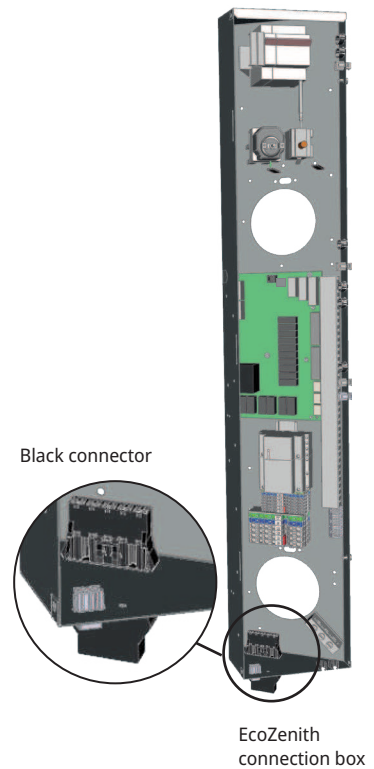

**!** NB: CTC speed-controlled heat pumps can be powered separately!  
**●**

Connector for supplying power to heat pumps!



Figure 1



Figure 2



Figure 3



Figure 4



Figure 5

## 13.4 Extra low voltage protection

The following outputs and inputs have extra low voltage protection: current sensor, outdoor sensor, room sensor, primary flow sensor, return sensor, NR/SO, temperature sensor, level switch and PWM signals.

### Connection of outdoor sensor (B15)

The sensor should be set up on the house's northwest or north side, so that it is not exposed to morning and evening sun. If there is a risk of the sensor being affected by the sun's rays, it must be protected by a screen.

Place the sensor at around 2/3 of the height of the facade near a corner, but not under a roof projection or other form of wind protection. Do not place it either above ventilation ducts, doors or windows where the sensor may be affected by factors other than the actual outdoor temperature.

### Connection of room sensor (B11) (B12)

The room sensor is fitted at a central point in the house, in the most open position possible, ideally in a hall between several rooms. This is the best position for the sensor to record an average temperature for the house.

Feed a three-conductor cable (minimum 0.5 mm<sup>2</sup>) between the heat pump and room sensor. Then attach the room sensor securely in a position roughly two thirds of the way up the wall. Connect the cable to the room sensor and EcoZenith.

**!** Do not attach the sensor cable permanently until you have tested where the best location is.

### Connection of primary flow sensor (B1, B2)/return sensor (B7)

fit the primary flow sensor to the primary flow pipe, ideally after the circulation pump. Fit the return sensor to the return pipe.

The sensing part is towards the end of the sensor (see sketch).

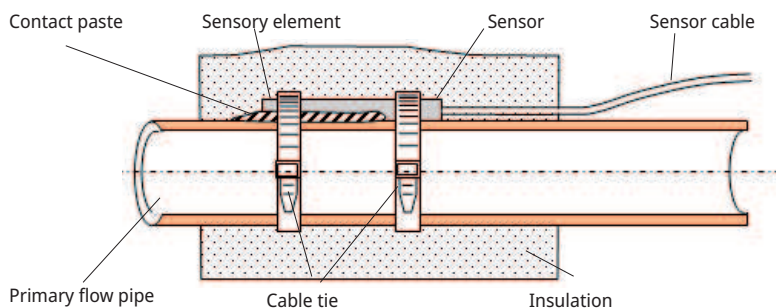

- Attach the sensor using the cable tie provided.
- Ensure that the sensor makes good contact with the pipe. Apply contact paste to the front part of the sensor between the sensor and the pipe if good contact is otherwise difficult to obtain.
- **NB:** Insulate the sensor using pipe insulation.

### 13.4.1 Current sensor connection

The three current sensors, one for each phase, are fitted on the fuse panel in the following manner:

Each phase from the electricity distribution board supplying the product is channelled through a current sensor before termination at the relevant terminal. This allows the phase current to be sensed all the time and compared with the value set for the heat pump's load switch. If the current is higher, the control unit drops to a lower heat output on the immersion heater. If this is insufficient, the heat pump is also limited. When the power drops back below the set value, the heat pump and immersion heater are reconnected.

This means that the current sensors, along with the electronics, prevent more power being supplied than the main fuses can tolerate.

The current sensors' cable holes are 11 mm in diameter.

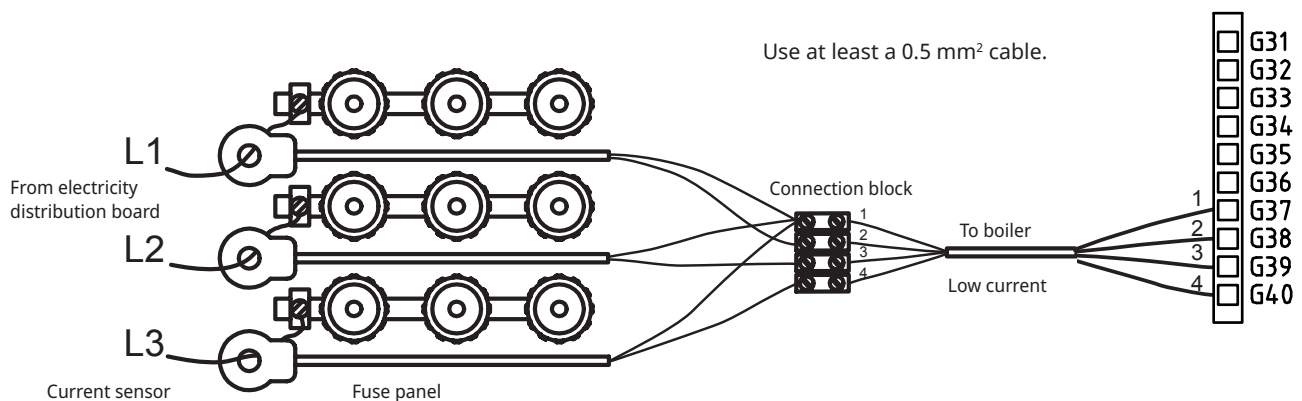

### 13.4.2 Terminal boards

There are terminal boards for sensors, radiator pumps, etc. behind the panel.

- ❗ Open the spring block first using a screwdriver before the cable is inserted.
- Otherwise, there is a risk of poor contact. Also make sure that the conductor is sufficiently stripped.

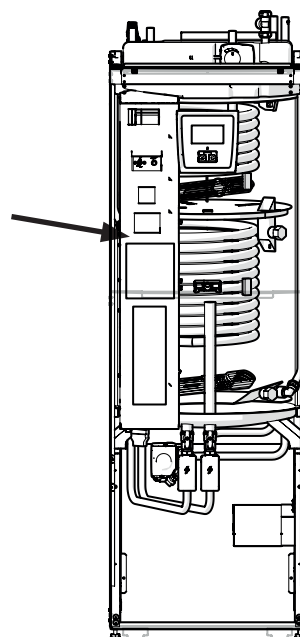
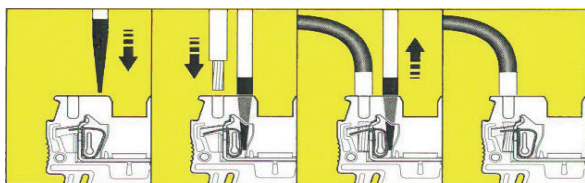

## 13.5 Settings to be carried out by the installation electrician

The following settings shall be made by the installation electrician after installation:

- Select main fuse size.
- Select the power limitation for the immersion heater.
- Check room sensor connection.
- Check that the sensors connected indicate reasonable values.

Carry out the checks below.

### Main fuse and effect limitation settings

Refer to the "First Start" section.

### Check room sensor connection

- Open the "Installer/Service/Function Test/Heating Circuit" menu.
- Go down and select the option LED room sensor and press OK.
- Select "On" using the "+" button and press "OK".  
Check that the room sensor LED lights up. If not, check the cables and connection.
- Select "Off" using the "-" button and press "OK". If the OK LED goes off, the check is complete.
- Return to start menu by pressing the Home button.

### Checking connected sensors

If any sensor is incorrectly connected, a message will appear on the display, e.g. "Alarm sensor outside". If several sensors are incorrectly connected, the different alarms are displayed on different rows.

If no alarm is displayed, the sensors are connected correctly.

The current sensor connection has no alarm, but the current value can be read in the Operation data menu. Note that the tolerance/accuracy is very low with small current values.

### 13.5.1 Installing a backup power supply

The DIP switch on the PCB is used to set the backup power supply. The DIP switch is marked "RESERV" (BACKUP).

When the switch is set to ON, the step is actively operating in backup heating mode.

#### 400V 3N~

Relay	EL3A	EL2B	EL2A	EL1B	EL1A
Current	5.3 A	10 A	2.6 A	10 A	1.3 A
Output	1.2 kW	2.3 kW	0.6 kW	2.3 kW	0.3 kW

#### 230V 1N~

Relay	-	EL2B	EL2A	EL1B	EL1A
Current	-	8.7 A	8.7 A	8.7 A	13 A
Output	-	2.0 kW	2.0 kW	2.0 kW	3.0 kW

#### 230V 3~

Relay	-	EL2B	EL2A	EL1B	EL1A
Current	-	10.2 A	5.1 A	10.2 A	5.1 A
Output	-	2.4 kW	1.2 kW	2.4 kW	1.2 kW



Example for  $1.2+0.6+0.3 = 2.1$  kW 3~

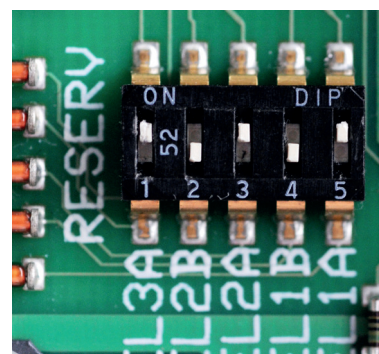

### 13.5.2 Switching to 18 kW immersion heater power

CTC EcoZenith i255 400V 3N~ can be reconnected to an 18 kW immersion heater.

NB: Installation must be carried out by a qualified electrician.

**Warning** Begin by disconnecting the power to the product. Installation must be carried out by a qualified electrician.

#### Connecting

1. Begin by disconnecting the power to the product.
2. Free the three black wires with insulation sleeves from the cabling.

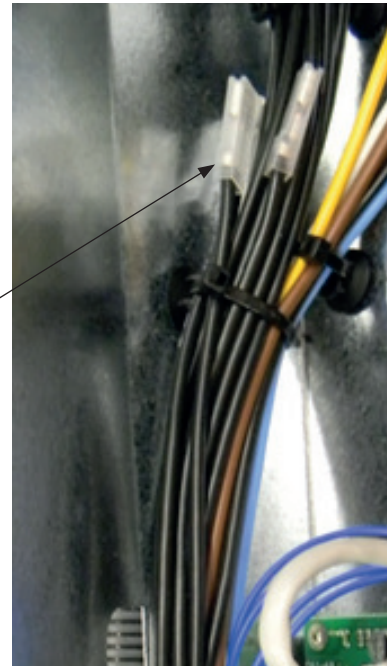
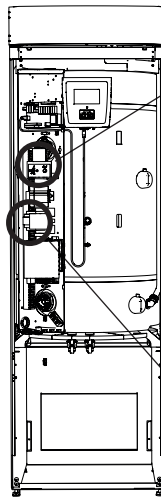

3. Undo the smallest switch (K2 on the electrical diagram) by pulling the yellow fastening backwards.

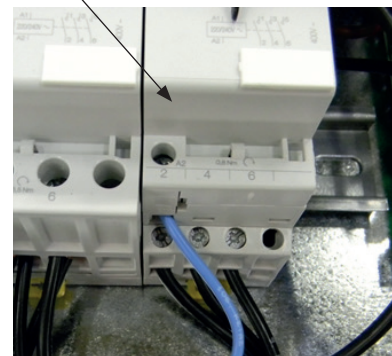

4. A code is printed on the black wires which indicates the cable number and connection position, e.g. 46 K2:1, where the 1 indicates screw joint position 1.
- Begin by loosening the screw joint at position 1 and freeing the brown wire. Fit the brown and black wires to the same screw joint.
  - Repeat for screw joints at positions 3 and 5.
- Tighten screw joints 1 through 5.
- Refit the contactor on the DIN rail and lock using the yellow catch.
  - Then check that the contactor is firmly in position on the DIN rail.

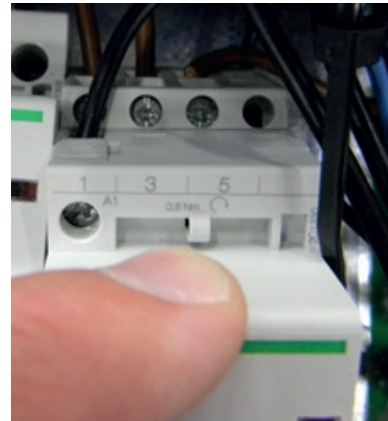

5. Mount the black wires in the free spaces on the immersion heater.
- NB:** Only for angled flat pins with black end cable sleeves.

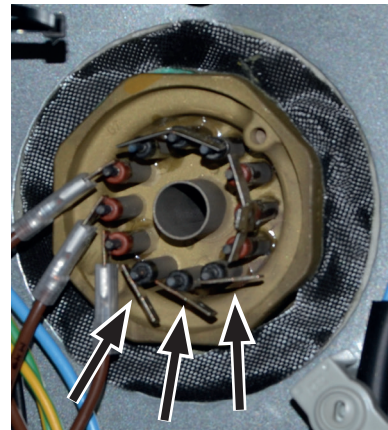

## 13.6 Connection of pump (G46) to Differential thermostat function

230V 1N~

The circulation pump (G46) is connected at the following terminal blocks:

Relay card in EcoZenith i255 (see wiring diagram).

Note the cable colours!

Phase:	brown	Terminal block A11
Neutral:	blue	
Earth:	yellow/green	

Check the function by test running the pump in the "Installer/Service/Function Test" menu in the control system.

## 13.7 Connection of sensor (B46) to Differential thermostat function

Ntc22k

Sensor B46 is connected to terminal block G65,G66

## 13.8 Resistances for sensors

Temperature °C	Outdoor sensor Resistance Ω
70	32
65	37
60	43
55	51
50	60
45	72
40	85
35	102
30	123
25	150
20	182
15	224
10	276
5	342
0	428
-5	538
-10	681
-15	868
-20	1115
-25	1443
-30	1883
-35	2478
-40	3289

Temperature °C	NTC 22 k Resistance Ω
130	800
125	906
120	1027
115	1167
110	1330
105	1522
100	1746
95	2010
90	2320
85	2690
80	3130
75	3650
70	4280
65	5045
60	5960
55	7080
50	8450
45	10130
40	12200
35	14770
30	18000
25	22000
20	27100
15	33540
10	41800
5	52400
0	66200
-5	84750
-10	108000
-15	139000
-20	181000
-25	238000



## 13.9 Component list, wiring diagram

No.	Component	
A1	Display	
A2	Relay/main card	
A3	CTC Solar controls/Expansion card	
A4	Soft-start card with motor protection and contactor function	
A5	HP control card	
B1	Primary flow sensor 1	NTC 22
B2	Primary flow sensor 2	NTC 22
B5	Upper tank sensor	NTC 22
B6	Lower tank sensor	NTC 22
B7	Return sensor	NTC 22
B11	Room sensor 1	NTC 22
B12	Room sensor 2	NTC 22
B15	Outdoor sensor	NTC 150
B46	Sensor external tank - Differential thermostat function	NTC 22
COM HP	Communication heat pump	G51 = Brown cable, G52 = white cable, G53 = green cable.
E13	Backup heating thermostat	
F1	Automatic circuit breaker 10 A	
F2	Automatic circuit breaker HP 10 A	
F10	Max thermostat	
G1	Heating circ pump 1	
G2	Heating circ pump 2	
G11	Charge pump	
G40	DHW Circulation pump	(Not controlled by the product, separate control/constant voltage)
G46	Charge pump external tank - Differential thermostat function	
H	H-tank	Internal main tank in the product
K1	Contactor 1	
K2	Contactor 2	
K22	Flexible remote control/SmartGrid	
K23	Flexible remote control/SmartGrid	
K24	Flexible remote control/SmartGrid	
K25	Flexible remote control/SmartGrid	
X1	Terminal block, incoming supply	
X10	Terminal block, HP supply	Black connector
Y1	Mixing valve 1	
Y2	Mixing valve 2	
Y11	Non return valve	
Y21	3-way valve DHW	
Y22	3-way valve DHW	
Y98	Expansion vessel	
Y99	Expansion vessel	



### 13.10 Wiring diagram 400V 3N~

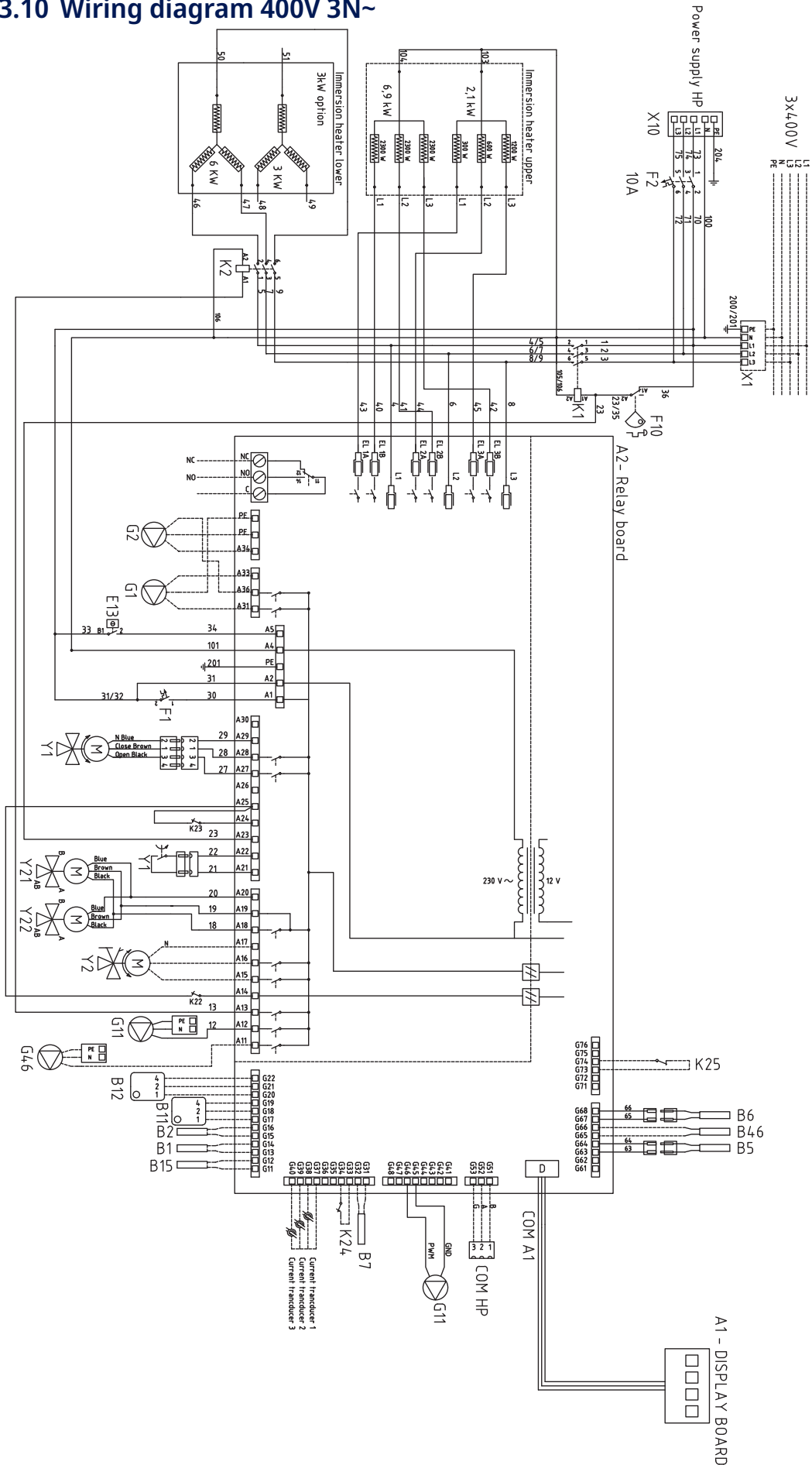

586241

### 13.11 Wiring diagram 230V 1N~

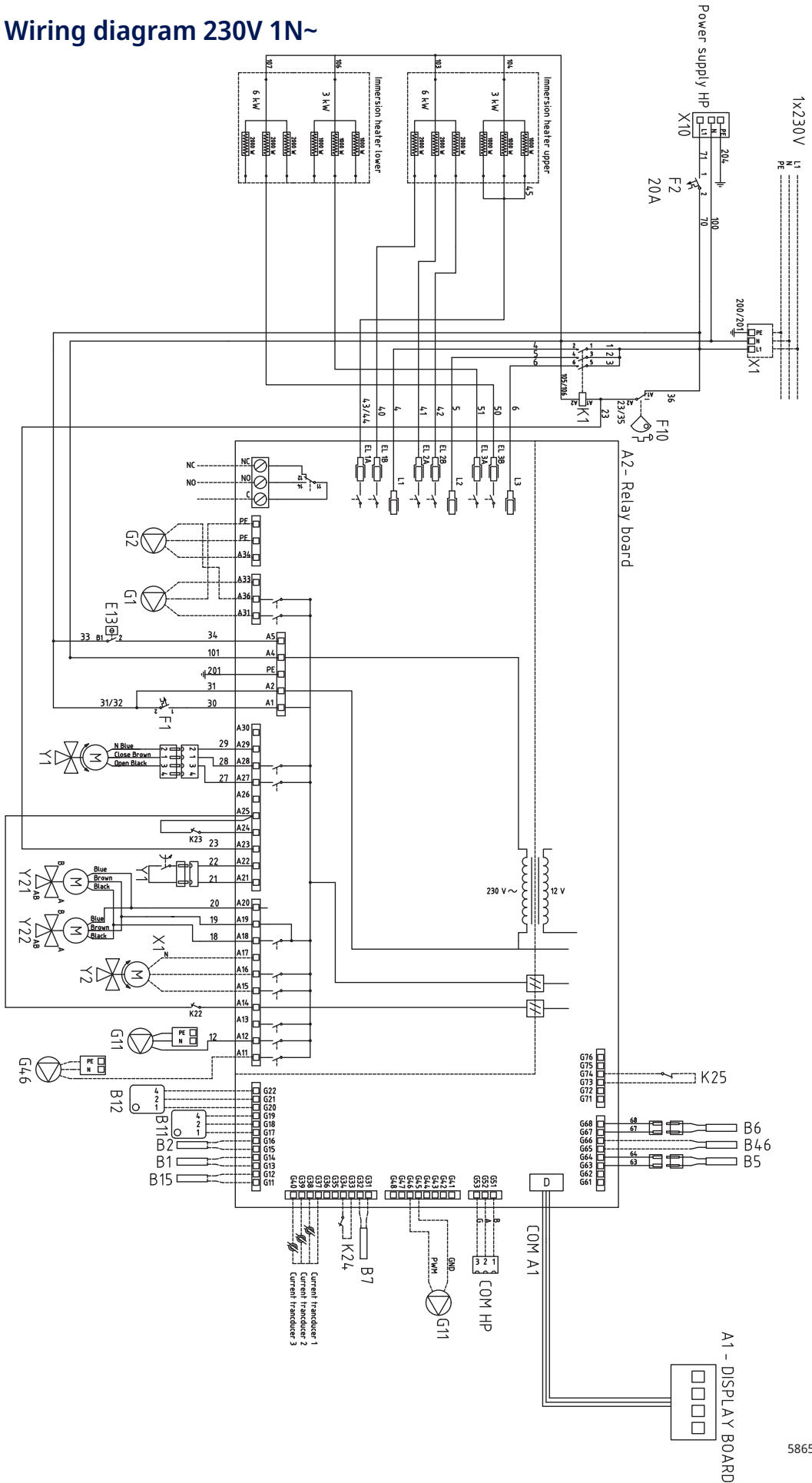

586595

### 13.12 Wiring diagram 230V 3~

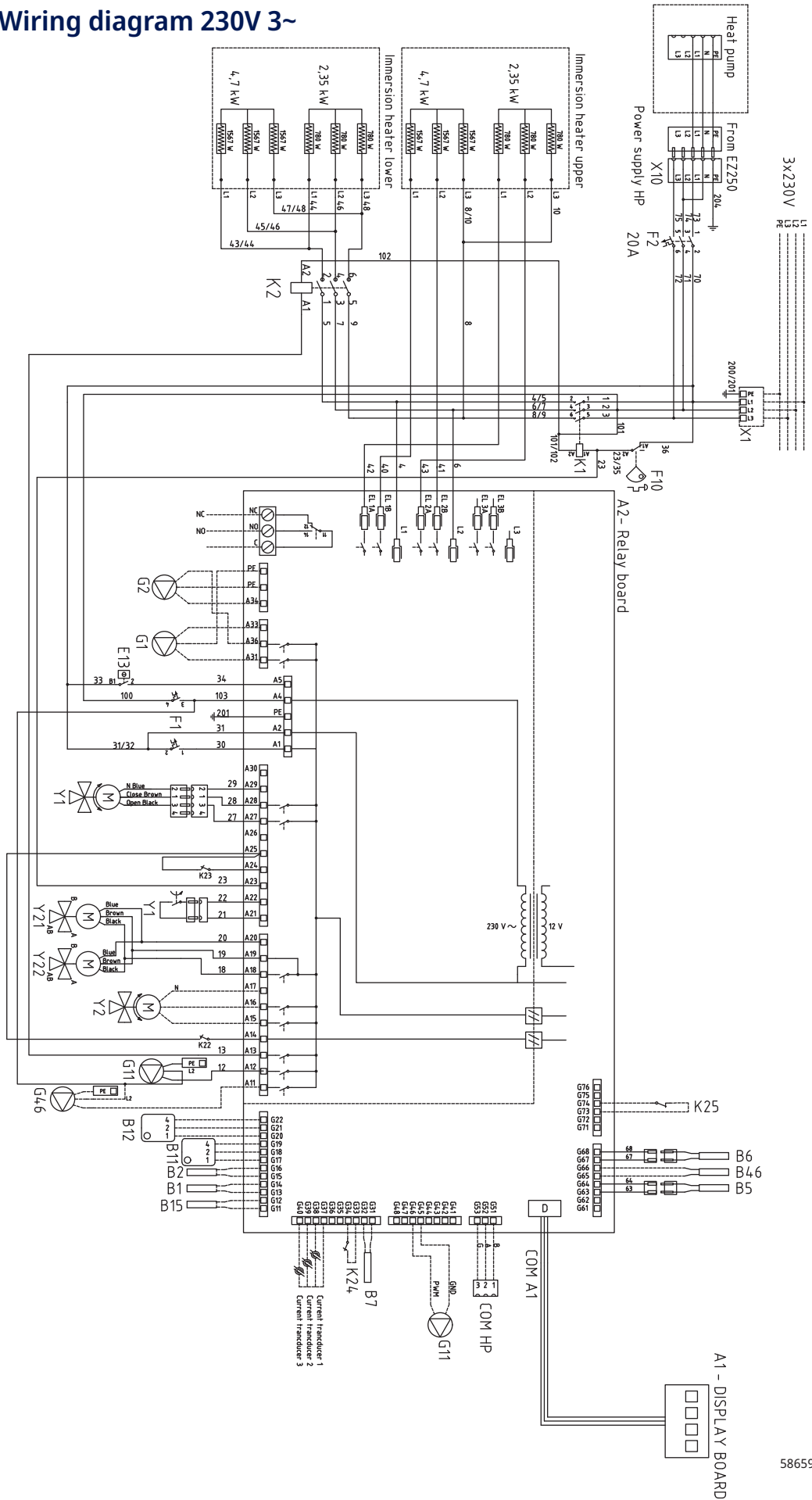

586596

# 14. Installation Communication

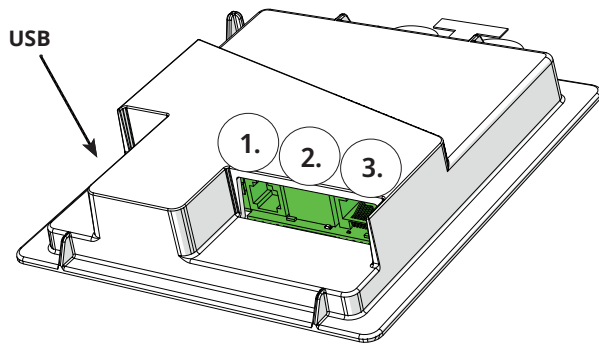

The back of the display unit has 3 communication ports.



Menu: "Installer/Define/Communication".



## Display communication ports

- 1 **Port 1. RS485 port without galvanic protection. For external equipment, e.g. property control (BMS\*).**

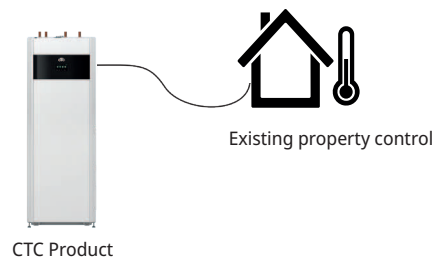

- 2 **Port 2. Network jack (ethernet), see connection information on following page.**  
Define the app:  
myUplink: "Yes" enables connection to the app.

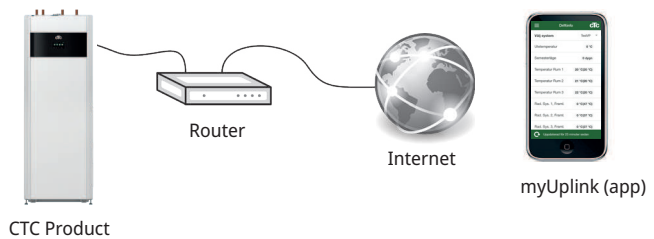

Define Web:  
"Yes" permits network connection, the "CTC Remote" screen mirror feature and BMS\* function with remote control via network cable to local network.

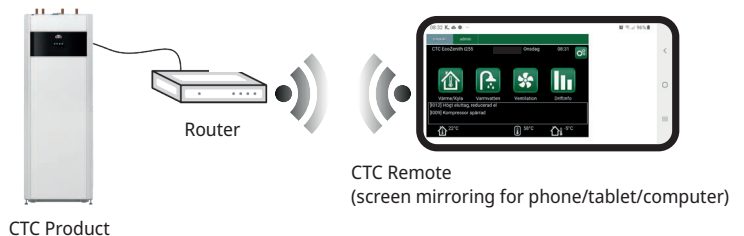

- 3 **Port 3. Communication between the product's electrical cabling and display: Factory fitted.**

\*Port 2 - Network socket (Ethernet) when connecting the BMS via TCP/IP.

## 14.1 Installing the network cable

**!** Turn off the product's main switch before opening the front.

1. Remove the front plate. Run the network cable in front of the product's top cover edge according to the arrows.

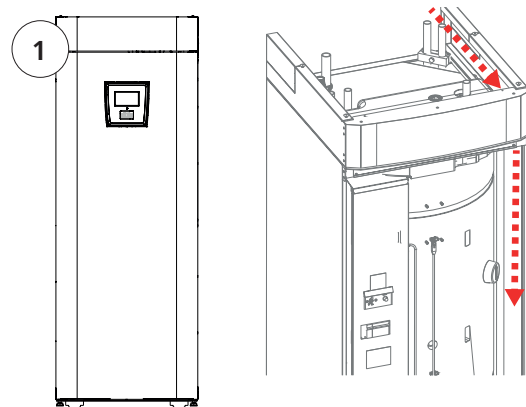

2. Open the ferrite from the packaging, clamp around the ethernet cable with the connector.

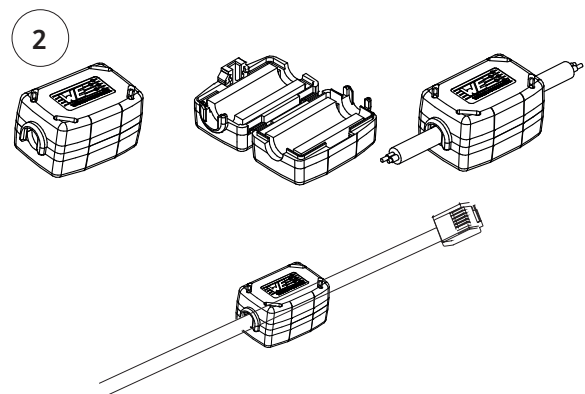

3. Connect the ethernet cable in the middle (Port 2).

4. Carefully refit the front. Pay attention to the cables.

5. Connect ethernet cable to network port or router.

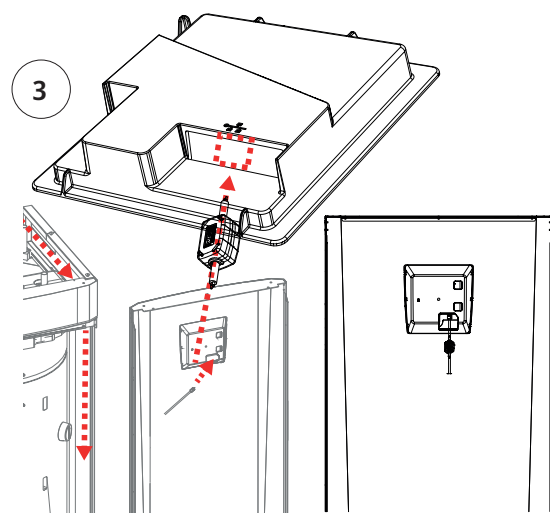

To activate and define a connection, refer to the "Installer/Define/Communication" menu. A more detailed description can be found in the "Control System" chapter.



## 14.2 Remote - Screen Mirroring

- Connect the ethernet cable, see previous page.
- Installer/Define/Communication/Web - Yes. Permits the product to connect with unencrypted web traffic on local area networks. Internet router and firewall required.
- Installer/i - Scan the QR code with a tablet or smartphone. 
- Save as favourite/icon on phone/tablet/computer. When your phone/tablet is connected to your local network, the product can be used with your device's touchscreen in the same way as the product's screen.
- In the app: scan QR code or enter address "http://ctcXXXX/main.htm". (XXXX = the last four digits of the display serial number, for example S/N 888800000040 = "http://ctc0040/main.htm"). In case of problems: click the link to update to the device's current IP no.



Tablet/Smartphone/PC as a touchscreen for local area network "Installer/Define/Communication/Web" - "Yes".

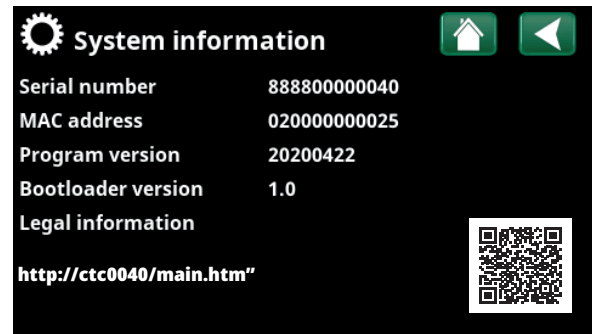

## 14.3 myUplink - App

Define myUplink. See "Installer/Define/Communication/myUplink - Yes".

Installing the app.

- Download myUplink from the App Store or Google Play.
- Create an account.
- Follow the instructions in the app's Help feature.

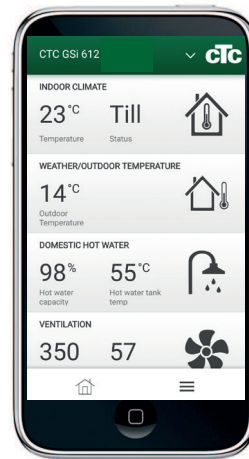

## 15. First start

When the heat pump is delivered, the compressor is blocked to avoid accidental start-up. The heat pump can be installed and started before the bedrock/ground source or air-to-water heat pump is commissioned.

The heat pump can also be started without the room sensor installed, as the set curve will control the heating. Deselect the room sensor under the "Settings" menu. However, the sensor can always be fitted for the alarm LED function.

### Before first start

1. Check that the heat pump and system are water-filled and bled. (The heat pump can be bled through the bleed valve on the top cover of the product).
2. Ensure that, where applicable, the brine system is filled with water and antifreeze and that it is bled or ensure that the compressor is blocked. (This applies to docking with a brine-to-water heat pump)
3. Check that all connections are tight.
4. Check that sensors and the radiator pump are connected to the power source.
5. The backup heating thermostat has OFF as its factory setting. Recommended mode is ❄️ = Frost protection setting, approx. +7 °C. The backup heating thermostat is located in the electrical switchboard behind the front panel. It is in the OFF position when it is turned anticlockwise as far as it will go (the screwdriver slot should be vertical).

Screwdriver slot



Symbol for backup heating thermostat:

**NB: At the end of the installation, check the current transformers' connection. In this situation it is important that you have switched off any major consumers of electricity in the house. Also make sure that the backup thermostat is turned off.**

### First start-up

Connect the power with the safety switch, the display window lights up. For settings, see chapter "Installation Guide".











[www.ctc.se](http://www.ctc.se), [www.ctc-heating.com](http://www.ctc-heating.com)  
+46 372 88 000  
Fax: +46 372 86 155  
P.O Box 309 SE-341 26 Ljungby Sweden



**MADE IN SWEDEN**