



Installation and Maintenance Manual

CTC EcoLogic S



Important!

- Read carefully before use, keep for future reference.
- Translation of the original instructions.

Table of contents

1.	Safety instructions	5
2.	Design	6
2.1	Display unit.....	6
2.2	Technical data.....	6
2.3	Scope of delivery.....	7
3.	EcoLogic S areas of use	8
3.1	Heating systems with/without 3-way valve.....	8
3.2	Heat pump for Property Control (BMS).....	10
4.	Detailed menu descriptions	11
4.1	Start menu.....	11
4.2	Display.....	13
4.3	Settings.....	15
4.4	Define.....	23
4.5	Service.....	24
5.	Parameter list EcoLogic S	27
6.	First start	28
6.1	Before first start.....	28
6.2	First start.....	28
7.	Operation and Maintenance	29
8.	Troubleshooting/Appropriate measures	29
8.1	Information messages.....	30
8.2	Alarm messages.....	31
8.3	Critical alarms - Risk of freezing.....	33
9.	Electrical installation	35
9.1	Power supply.....	35
9.2	Communication between EcoLogic and EcoAir/EcoPart.....	35
9.3	Outdoor sensor B15 (EcoPart).....	35
9.4	Thermostat control K26 / Control signal external 3-way valve.....	35
9.5	Connecting to terminal block and circuit board A5.....	36
9.6	Connecting a separate communication cable.....	36
9.7	Connecting control card EcoAir/EcoPart.....	37
10.	Installation Communication	38
10.1	Remote - Screen Mirroring.....	39
10.2	myUplink - App.....	39
11.	Appendix	40
11.1	Types of Operation with CTC EcoEI V2.....	40

Software update



software.ctc.se

EN

For more information on updated functions and downloading the latest software, see the website "software.ctc.se".

Congratulations on your new product!



You have just purchased a CTC EcoLogic S. Save this manual containing the installation and maintenance instructions. You will be able to enjoy the benefits of your CTC EcoLogic S for many years, and this manual provides all the information you will need.

CTC EcoLogic S has a control system that:

- allows supplementary heat pumps to be added to existing systems.
- monitors and controls your heat pump.
- allows for individual settings.
- displays desired values, for instance, temperature and operating status.
- allows settings to be made in a simple and structured manner.

Thanks to the flexible set-up with clear and simple options for settings, CTC EcoLogic S is the perfect solution for adding heat pumps to existing systems.

CTC EcoLogic S is fully equipped for connection with the CTC EcoAir outdoor air heat pump or CTC EcoPart ground source heat pump.

Important to remember!

Check the following points in particular at the time of delivery and installation:

- Remove the packaging and check that the product (electrical connection box and display) has not been damaged in transit. Report any transport damage directly to the carrier.
- Check for missing parts.
- The product must not be installed where the ambient temperature is higher than 60 °C.
- CTC EcoAir/EcoPart must have software version HP control card 2020-11-01 or later, if older version - contact your installer.
- Register your product for warranty and insurance via the website <https://www.ctc-heating.com/customer-service#warranty-registration>
- Click the "i" button" in the lower right corner of the screen in the "Installer" menu, this displays the product's serial number.
- Click on "Heat pump" on the main menu page for "Operation data" to see "Software version HP PCB".

i Information in this type of box [i] is intended to help ensure that the product functions optimally.

! Information in this type of box [!] is particularly important for correctly installing and using the product.

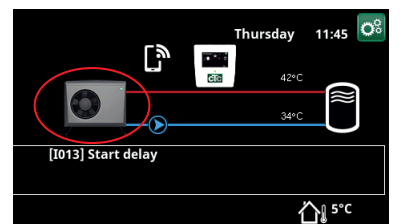
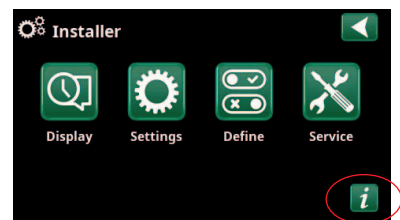

! If these instructions are not followed during the installation, operation and maintenance of the system, Enertech's liability under the applicable warranty terms is not binding.

For your own reference

Fill in the information below. It may come in useful if anything should happen.

Product:	Serial number:
Installer:	Name:
Date:	Tel. no.:
Electrical installer:	Name:
Date:	Tel. no.:

No liability is accepted for any misprints. We reserve the right to make design changes.

1. Safety instructions



Turn off the power with an omnipolar switch before doing any work on the product.



The product must be connected to protective earth.



The product is classified as IPX1. The product must not be rinsed with water.



When handling the product with a hoist ring or similar device, make sure that the lifting equipment, eyebolts and other parts are not damaged. Never stand under the hoisted product.



Never jeopardise safety by removing bolted covers, hoods or similar.



Any work on the product's cooling system should be carried out by authorised personnel only.



Installation and connection in the product must be carried out by a authorised electrician. All piping must be installed according to the applicable requirements.

Service of the product's electrical system must only be carried out by a qualified electrician in compliance with the specific requirements of the national standard for electrical safety.

Replacement of damaged supply cable, must be carried out by the manufacturer or qualified service engineer to avoid risk.



Safety valve check:
-Safety valve for boiler/system to be checked regularly.



The product must not be started if it is not filled with water; instructions are in the "Pipe installation" section.



WARNING: Do not switch on the product if there is a possibility that the water in the heater is frozen.



This device can be used by children from the age of eight years and above and by people with reduced physical, sensory or mental ability or lack of experience or knowledge if they have been taught, either with supervision or with the instructions provided, how to use the device safely and understand the risks involved. Children should not play with the device. Cleaning and maintenance should not be carried out by children without supervision.



If these instructions are not followed when installing, operating and maintaining the system, Enertech's commitment under the applicable warranty terms is not binding.

2. Design

2.1 Display unit

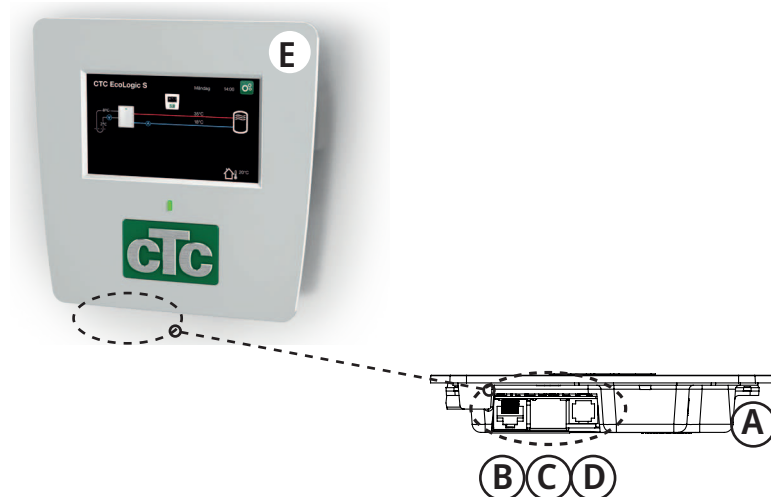

- A USB port
- B Power supply display unit/internal communication
- C Network connection (Ethernet)
- D BMS connection
- E Display unit
- F Communication cable display unit – heat pump

2.2 Technical data

CTC no. EcoLogic S (EcoAir / EcoPart)	6212576 / 6212593
Supply	24V DC
Outdoor sensor (CTC EcoPart)	2.2 k Ω
Display	4.3 inch colour touchscreen
Memory	retains memory during power failure
Backup batteries	not required
Clock	controlled in real-time
Weight (packaged weight)	0.8 (1) kg
Display dimensions (depth x width x height)	28 x 159 x 160 mm
Enclosure class (IP)	IP X1

2.3 Scope of delivery

The figure below shows the main components in the EcoLogic delivery.

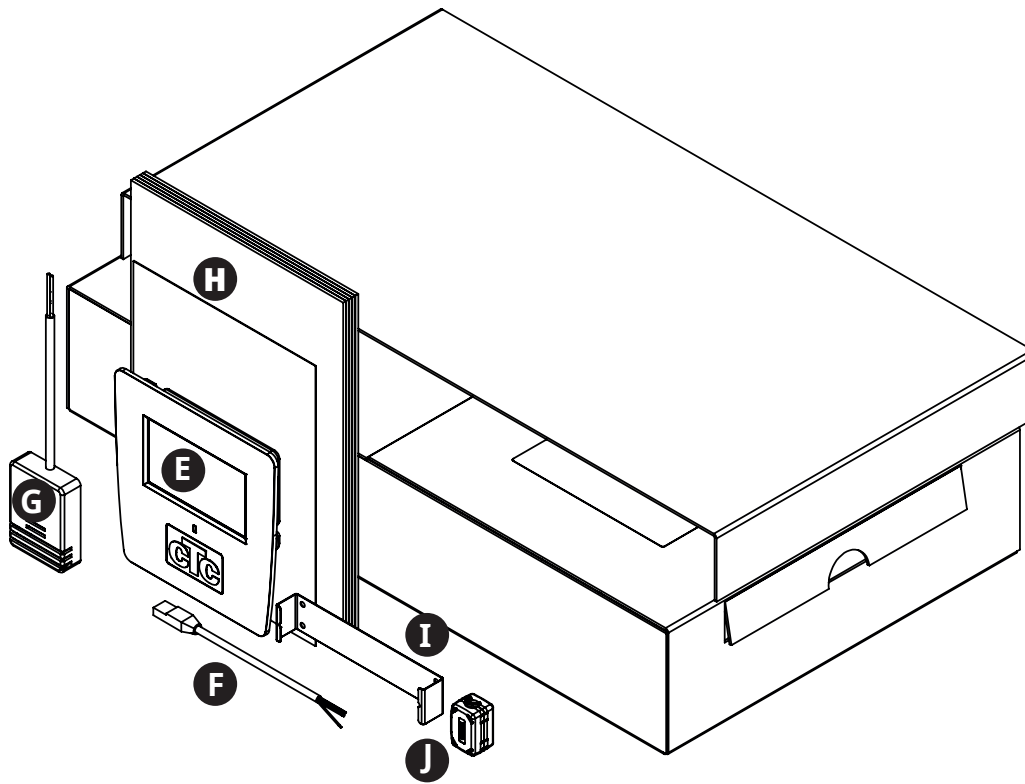

- G Outdoor sensor (applies to connection to heat pump, model CTC EcoPart)
- H Installation and Maintenance Manual
- I Display unit bracket
- J Ferrite

3. EcoLogic S areas of use

3.1 Heating systems with/without 3-way valve

System description

Thanks to the settings options in EcoLogic S, operation of the heat pump can be adapted to the existing boiler's conditions and settings.

The control of the existing heating system manages the distribution of heat and hot water in the same way as before.

Conditions

The installation must be adapted on a case-by-case basis depending on the conditions of the existing heating system. It is important that installation is carried out in full accordance with the respective product's installation instructions. Refer to the relevant heat pump manual for details about electrical installation, flow requirements, volume requirements, temperature requirements and more. In some cases, the existing boiler's settings may need to be adapted to enable heat pump installation.

The heat pump's operating parameters must be adjusted in relation to the existing heating system setting. The main principle is that EcoLogic S should be the primary heat producer and receive the start signal before the boiler.

The settings must be adjusted to minimise the need for additional energy. This is done by setting the heat pump's heat curve a few degrees higher than the existing boiler's heat curve. To optimise the heating circuit, these settings should be subsequently fine-tuned for optimal functionality under different operating conditions.

Note that EcoLogic S and the heat pump should be considered supplementary to the existing heating system in terms of safety functions such as additional heat and backup heating thermostat. These functions will be retained in the existing heating system.

3.1.1 Heat pump for existing heating system (without 3-way valve)

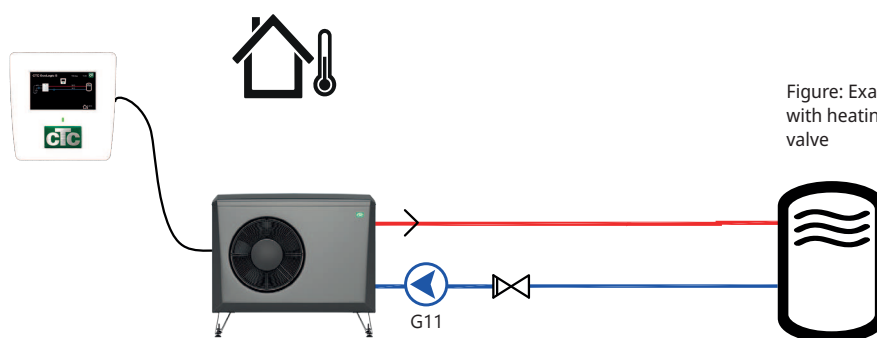

Figure: Example of system solution with heating system without 3-way valve

System description

This type of connection allows a ground source or air/water heat pump to be added to the existing heating system consisting of, for example, heat pump (exhaust air, ground source), electric boiler, wood boiler, oil boiler or pellet boiler.

Conditions

The heat pump must be installed, in terms of flow, before the existing heating system. Preferably by interrupting the return flow from the heating circuit.

3.1.2 Heat pump for existing heating system (with 3-way valve solution)

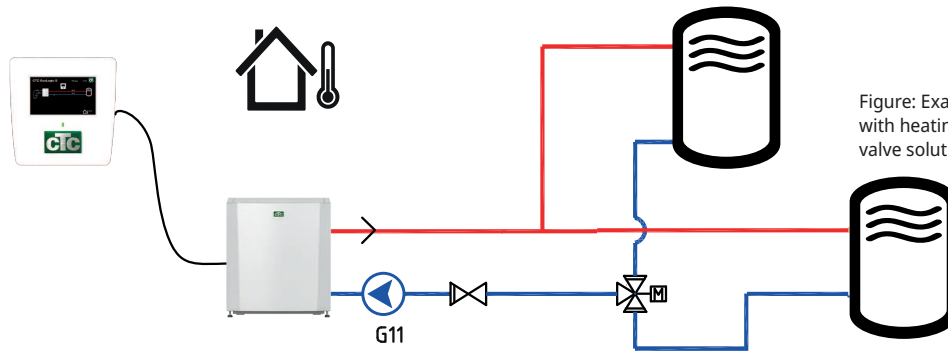

Figure: Example of system solution with heating system with 3-way valve solution

System description

This type of connection allows a ground source or air/water heat pump to be added to the existing heating system consisting of, for example, heat pump (exhaust air, ground source), electric boiler, wood boiler, oil boiler or pellet boiler, with 3-way valve control for DHW production.

Conditions

The heat pump must be installed, in terms of flow, before the existing heating system. Preferably by interrupting the return flow from the heating circuit. In cases where the 3-way valve is located outside the heating system, the heat pump must be installed before the 3-way valve.

When the 3-way valve switches to DHW, EcoLogic is signalled to activate a fixed setpoint so that the heat pump can also be used for hot water production.

3.1.3 Replacing a heat pump connected to CTC EcoEI

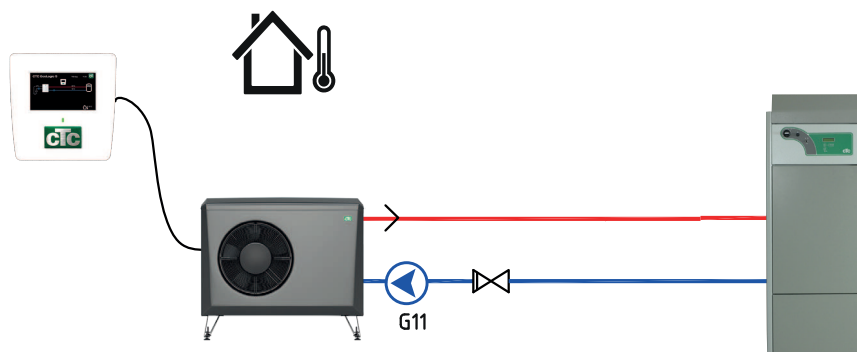

Figure: Examples of system solution connected to older heating system, e.g. CTC EcoEI

System description

For installations where the existing heat pump is connected to the CTC EcoEI V1/ V2/V3 electric boiler and the heat pump needs to be replaced.

Conditions

The existing heat pump will be replaced by the new heat pump. The electric boiler power output is limited in order to minimise the need for additional energy. To optimise the heating circuit, the heat pump settings should be subsequently fine-tuned for optimal functionality under different operating conditions.

To disconnect the existing heat pump and convert the electric boiler in order to limit the power output, refer to Appendix "Types of Operation with CTC EcoEI V2".

3.2 Heat pump for Property Control (BMS)

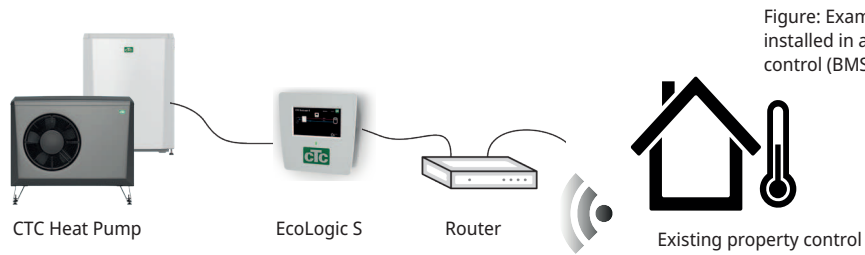

Figure: Example showing heat pump installed in a system with property control (BMS).

System description

For installations where the heat pump must interact with a property control.

Conditions

EcoLogic S is connected to a local network and control signals to the heat pump are sent via the BMS interface from the existing property control.

Refer to the "Detailed Menu Descriptions" chapter for information on how to define the Modbus TCP protocol and the digital BMS input, as well as apply settings for heating and DHW systems.

4. Detailed menu descriptions

4.1 Start menu

The system start menu displays an overview of the current operation data.

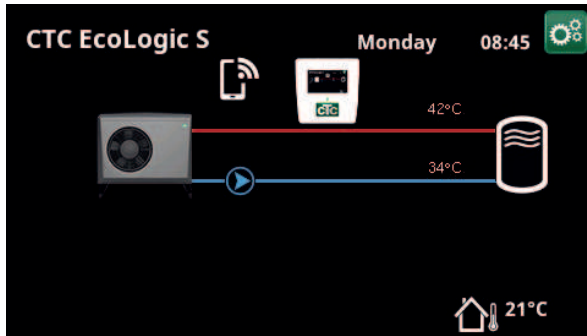



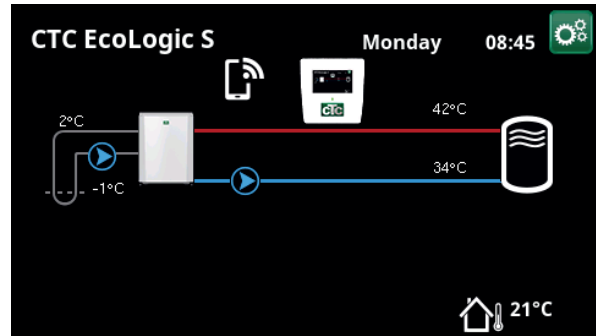



Main menu. Connected heat pump: CTC EcoAir (air/water HP).



Main menu. Connected heat pump: CTC EcoAir (liquid/water HP).

Depending on which system is defined, the following symbols may appear on the start menu:

	Control system EcoLogic S	Display
	Outside temperature	Measured temperature, outdoor sensor.
	Brine temperature	Current temperature (2 °C) of the brine from the collector in the liquid/water heat pump and return temperature (-1 °C) of the brine back into the collector hose.
	External buffer tank	Current primary flow temperature (42 °C) to the tank is shown on the left. Current return temperature (34 °C) is shown below.
	Heat pump, air/water	The air/water heat pump is connected to the circuit. The in and out temperatures of the heat pump are shown on the right.
	Heat pump, liquid/water	The liquid/water heat pump is connected to the circuit. The in and out temperatures of the heat pump are shown on the right at the buffer tank.



4.1.1 Control unit EcoLogic S

Click the display symbol in the start menu to view CTC EcoLogic operation data.

Status HC/Off

Displays the system status.

Primary flow °C 50 (55)

Shows the temperature out to the buffer tank as well as the setpoint in brackets.

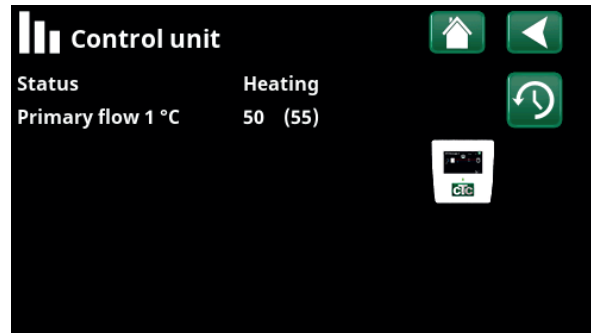

Menu: "Control unit EcoLogic S".



4.1.2 Stored oper. data

This menu shows cumulative operation values.

The operation values shown in the menu screenshots are only examples. The historical operational info presented varies depending on the language choice.

Total operation time h 3500

Shows the total time the product has been powered.

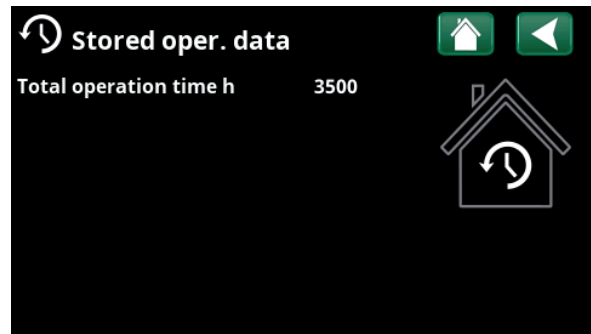

Menu: "Control unit / Stored oper. data".



Installer

This menu contains four sub-menus:

- Display
- Settings
- Define
- Service



For "System Information", click the "i" button in the lower right corner of the screen in the "Installer" menu. This displays the product serial number, MAC address, and application and bootloader versions. Click "Legal Information" to view information regarding third-party licences.

Scan the QR code with a tablet or smartphone. When your phone/tablet is connected to your local network, the product can be used with your device's touchscreen in the same way as the product's screen.

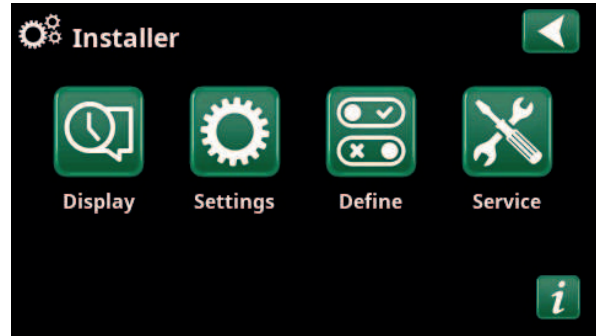

Menu: "Installer".

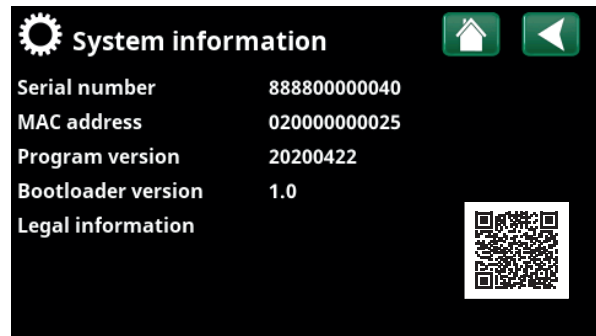

Menu: "Installer/System information". To access this menu, click the "i" button in the lower right corner of the "Installer" menu.



4.2 Display

Time, language and other screen settings can be carried out from this menu.



4.2.1 Setting the time

Time and Date

Click on the time symbol. The menu can also be accessed by clicking the date or time in the upper right corner of the start screen.

Press "OK" to highlight the first value and use the arrows to set the time and date.

DST (On, Active)

The left value can be set. "On" means the time is adjusted according to Summer Time.

The right value is fixed and shows the current status (for example, "Off" during the winter period). The display does not need to be connected to power for the values to be adjusted, since this occurs at the next start-up.

SNTP

Menu option "On" retrieves the current time from the internet (if online). More settings options can be found in the "Installer/Settings/Communication/Internet" menu.

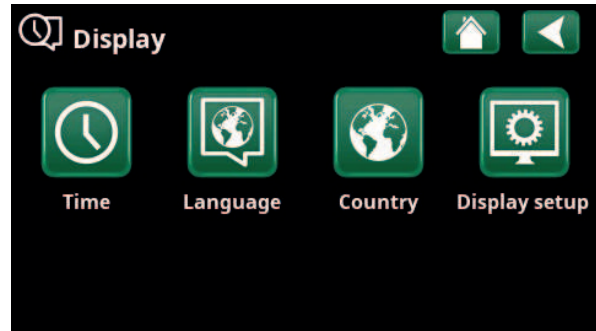

Menu: "Installer/Display".

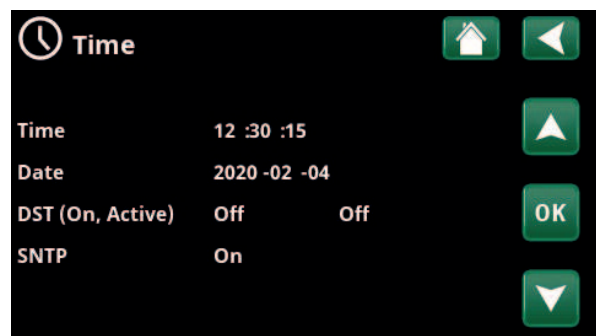

Menu: "Installer/Display/Time".



4.2.2 Language

Click a flag to select the language. The language selected is highlighted with a green square. To view more language options than those shown in the menu, scroll down the page, or press the down arrow key.



4.2.3 Country

Click on the "Country" symbol in the "Installer/Display" menu to display selectable countries and regions. The country that is displayed (highlighted in green) depends on which language has been selected.

"English" is the default language setting, which means that "GB United Kingdom of Great Britain and Northern Ireland" is the default country setting.

Select the country where the plant is installed to get correct spot prices. Depending on which country is selected, product-specific factory settings may vary.

"Country" must also be selected to receive correct electricity prices when controlling electricity prices via the myUplink mobile app.



4.2.4 Display setup

Sleep delay 120 (Off, 1...360)

Enter the time in minutes before the display enters sleep mode if not touched. Settings can be applied in 10 min. intervals.

Backlight 80% (10...90)

Set the brightness of the backlit display.

Click sound Yes (Yes/No)

Enable or disable button sounds.

Alarm sound Yes (Yes/No)

Enable or disable alarm sounds.

Time zone, GMT +/- +1 (-12...14)

Set your time zone (relative to GMT).

Lock code 0000

Press "OK" and use the arrows to set a 4-digit lock code. If a lock code is set, it is shown as four stars. You will be prompted to enter the code when the screen is restarted.

NB: Make a note of the lock code for your own reference when you enter it in the menu for the first time.

The serial number of the display (12 digits) can also be entered to unlock the display (enter '0000' + serial number); see chapter "Installer/System Information".

The display can be locked by clicking the product name in the upper left of the start menu, whereupon you will be prompted to enter the lock code.

A lock code can be deleted by entering "0000" in this menu instead of the previously specified lock code.

Font size Standard (Small/Standard/Large)

The display's font size can be changed here.

Selection colour 0 (0/1/2)

Option to change the cursor background colour for clearer selection according to the light conditions.

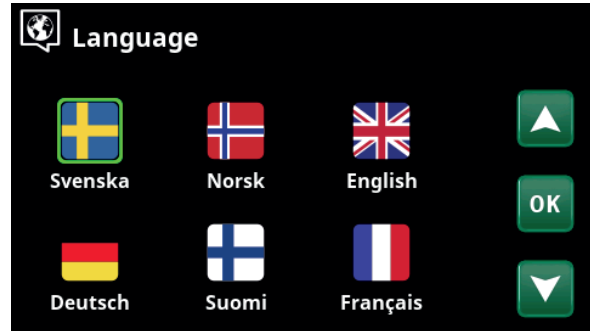

Menu: "Installer/Display/Language".



Menu: "Installer/Display/Country".

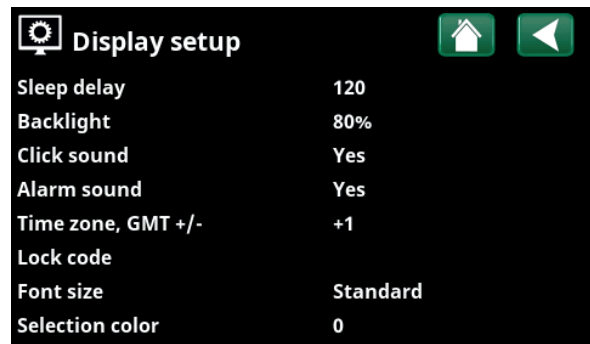

Menu: "Installer/Display/Display Setup".



4.3 Settings

4.3.1 Settings Heating Circuit

4.3.1.1 Control on outdoor sensor/inclination

EcoLogic S controls the charging of the external heating tank based on the set heat curve. The inclination of the heat curve indicates the temperature to which the external heating tank must charge at different outdoor temperatures.

The outdoor sensor used depends on the type of heat pump connected to the system:

Liquid/water heat pump (CTC EcoPart)

- packaged outdoor sensor must be installed (refer to the "Electrical installation/Connecting the control card EcoAir/EcoPart" chapter).

Air/water heat pump (CTC EcoAir)

- the existing outdoor sensor of the heat pump is used.

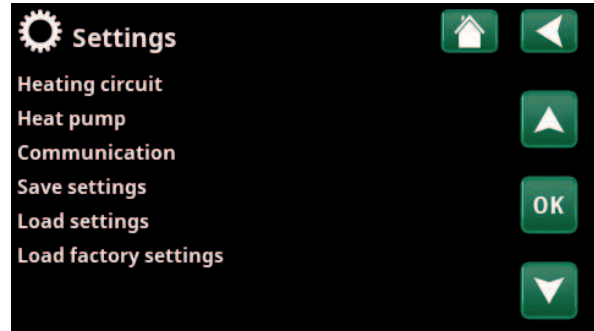

Menu: "Installer/Settings".

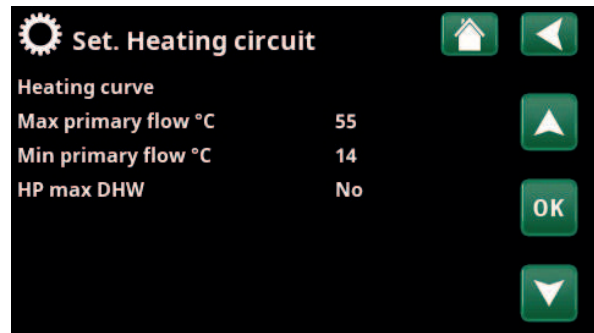

Menu: "Installer/Settings/Heating Circuit" when controlling outdoor sensor.

Heating curve

The heating curve determines the primary flow temperature (and thus the indoor temperature) to the heating circuit at different outdoor temperatures.

See chapter "House heating curve" for more information on adjusting the heating curve.

Possible choices are "Set. heating curve", "Fine adjustment", "Active curve", "Copy from ..." and "Reset curve".

• Set. heating curve

The thicker line shows the factory-set curve while the thinner line shows the active heat curve to be reset. Here it is possible to adjust the appearance of the graph by adjusting the curve inclination and curve adjustment with the buttons below the graph. The adjustments you make here affect the entire appearance of the graph, while the changes made under "Fine adjustment" are made one point at a time. Curve inclination is adjusted with the left and right arrows while curve adjustment is adjusted with the up and down arrows. Confirm with "OK".

• Fine adjustment

The graph of the active heating curve for the heating circuit is displayed. The heating curve can be adjusted in 5 points on the graph. Touch a point (becomes green) to change its position in the x-axis (outdoor temperature) and y-axis (primary flow temperature). Use the up/down/left/right buttons below the graph or press and drag the point.

Below the graph, the outdoor and primary flow temperatures for the selected point are shown. The heating curve can also be adjusted from the "Heating/Cooling" menu. See chapter "Control system / heating/cooling".

• Active curve 1 (1/2)

This menu bar shows the selected heating curve, it is possible to choose between two different heating curves per heating circuit.

• Copy from 1 (2)

The function "Copy from ..." is useful if you have created two different heat curve graphs but want to restore one graph to the same appearance as the other and then make changes.

Example: If heat curve 1 is selected as "Active curve", heat curve 1 will have the same appearance as heat curve 2 by selecting the line "Copy from 2" and pressing "OK". The menu bar cannot be selected (marked with gray) when heating curves 1 and 2 have the same values (the graphs look the same).

• Reset curve

Resets the active heating curve to the factory-set curve.

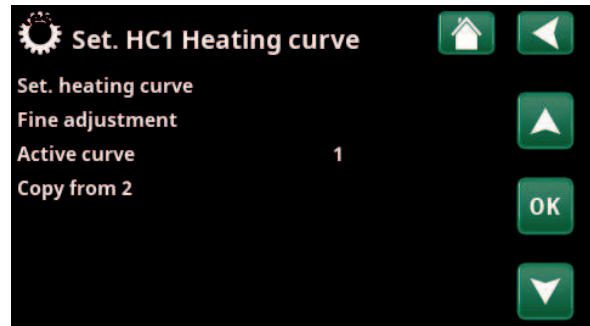

Menu "Installer/Settings/Heating Circuit/Heating Circuit 1/Heating curve".

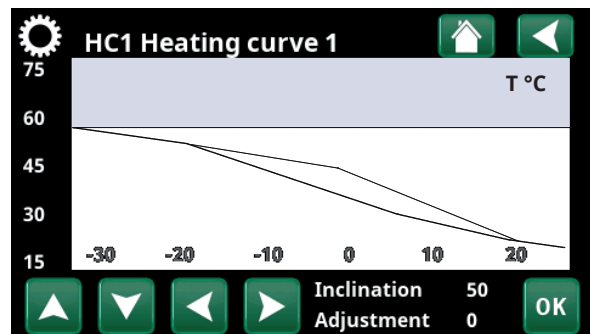

Menu "Installer/Settings/Heating Circuit/Heating Circuit 1/Heating curve".

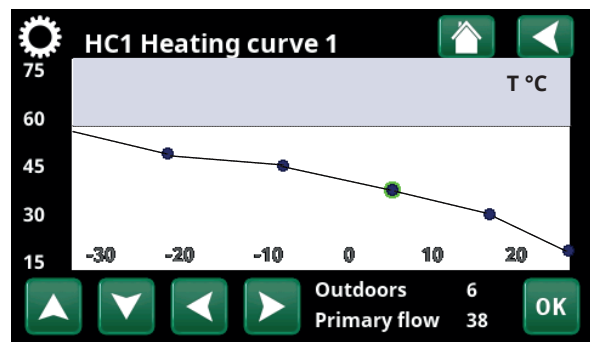

Menu "Installer/Settings/Heating Circuit/Heating Circuit 1/Heating curve/Fine adjustment".

Max primary flow °C 55 (30...80)

Maximum temperature (sensor HP_{out}) permitted out to the external heating tank.

Min primary flow °C 14 (14...65)

Minimum temperature (sensor HP_{out}) permitted out to the external heating tank.

HP max DHW No (No/Yes)

Specify whether the charging temperature should be raised to 60 °C every fourth time the compressor starts.

HP max DHW can only be selected when external control is not active.

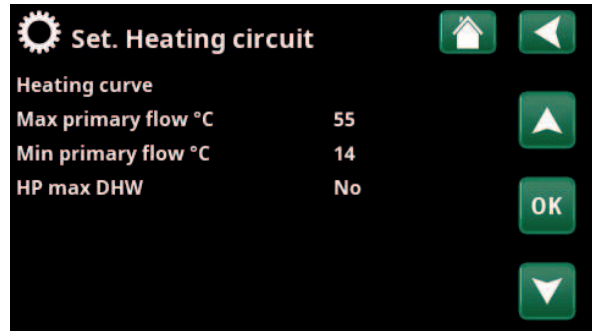

Menu: "Installer / Settings / Heating Circuit" when controlling outdoor sensor.

4.3.1.2 Remote control (external control)

For external control, the Normally Open (NO) or Normally Closed (NC) mode is determined first for the external control signal. This setting is applied in the "Installer / Define / Remote Control" menu.

Applies only for modulating heat pumps.

Refer to the "Installer / Define / Remote Control" chapter for more information on how the remote control function works.

Ext. control temp °C 30 (30...60)

Select the temperature for the external heating tank for remote control.

This menu bar is displayed if external control is active (NO/NC has been defined).

Ext. control temp DHW °C 30 (30...60)

Select the temperature for the external DHW tank for remote control.

This menu bar is displayed if external control is active (DHW NO/DHW NC has been defined).

Other settings in the menu apply when external control is not active.

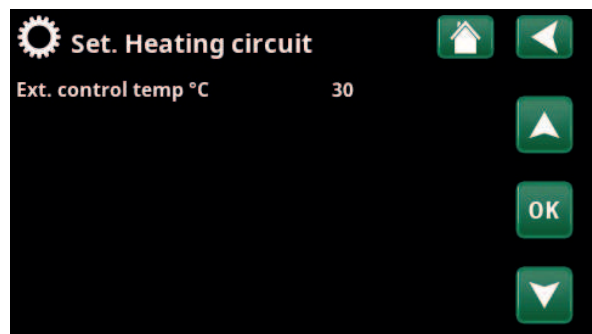

Menu: "Installer / Settings / Heating Circuit" for remote control of external heating or DHW tank.

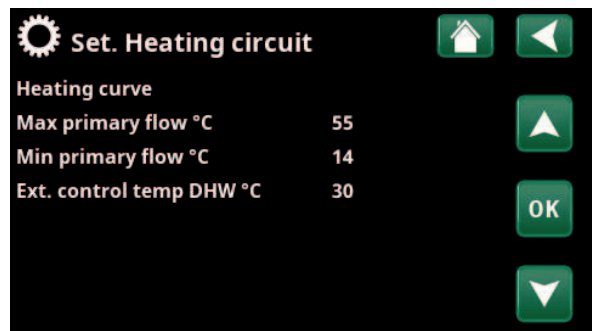

Menu: "Installer / Settings / Heating Circuit" for remote control of external DHW tank.

4.3.2 Settings Heat pump

Compressor **Blocked (Permitted/Blocked)**

The heat pump is supplied with a blocked compressor. "Permitted" means that the compressor is allowed to start.

Stop at outdoor °C **-22 (-22...10)**

This menu relates to settings for the outdoor temperature at which the compressor is no longer permitted to operate. The heat pump starts 2°C above the set value.

Only applies to air-to-water heat pumps.

Charge pump % **50 (20...100)**

The speed of the charge pump is set here. Refer to the heat pump's "Installation and Maintenance Manual" for more information.

Cold temp limit **0 (0...-15)**

Temperature limit for "winter power". When the outdoor temperature is equal or lower (T2), the compressor speed is adjusted up to speed R2.

Only applies to modulating air-to-water heat pumps.

Max RPS **90* (50...120)**

The maximum permissible speed of the compressor at "winter temperature". Sets the compressor's maximum speed (R2) at outdoor temperature T2.

Only applies to modulating air-to-water heat pumps.

Warm temp limit **20 (0...20)**

Temperature limit for "summer power". When the outdoor temperature is equal or higher (T1), the compressor speed is adjusted down to speed R1. The heat pump starts and stops at the actual value and setpoint value.

Only applies to modulating air/water heat pumps.

Max RPS warm temp **50 (50...120)**

The maximum permissible speed of the compressor at "summer temperature". Sets the compressor's maximum speed (R1) at outdoor temperature T1.

Only applies to modulating air/water heat pumps.

Compressor stop at brine °C **-5 (-7...10)**

Specify the brine temperature at which to stop the compressor.

Only applies to liquid/water heat pumps.

Brine pump **Auto (Auto/10 days/On)**

After installation is complete, you can choose to run the brine pump constantly for 10 days to remove air from the system. The brine pump then enters "Auto" mode. "On" means the brine pump runs constantly.

Only applies to liquid/water heat pumps.

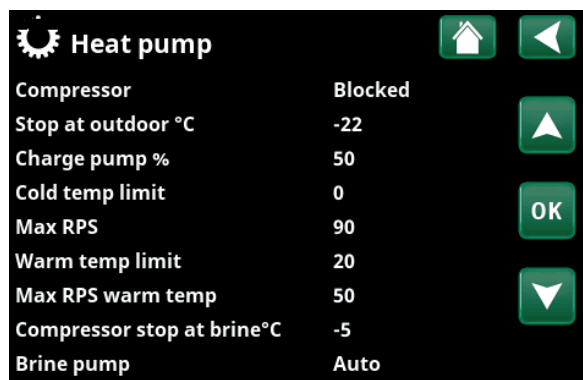

Menu: "Installer / Settings / Heat Pump".

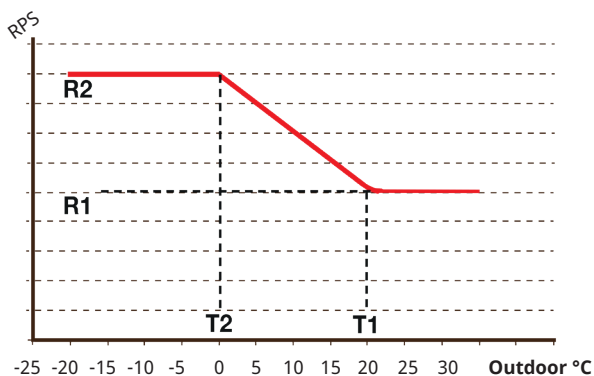

The diagram shows that the compressor speed is controlled according to the outside temperature.

When the outside temperature is below T2, the compressor speed adjusts up to R1.

When the outside temperature exceeds T1, the compressor speed adjusts down to R1.

These temperature and speed limits are set in the menus on the left.

*The value may vary depending on the heat pump model.

4.3.3 Settings Communication

Settings can be made here to control the product with a controlling system.

4.3.3.1 Settings Ethernet

DHCP Yes (Yes/No)

"Yes" enables automatic connection to the network.

If "No", custom router settings (IP address, Netmask and Gateway) as well as DNS setting must be made.

Auto DNS Yes (Yes/No)

If "Yes", default DNS server settings are used. If "No", custom DNS settings must be made.

SNTP Server

Option for custom SNTP server settings.

Connection speed 100mbit

Connection speed is specified here.

The factory-set connection speed is 100 mbit/s.

 For more information about connecting an ethernet cable, refer to the "Installation, Communication" chapter of this manual.



Menu: "Installer/Settings/Communication".

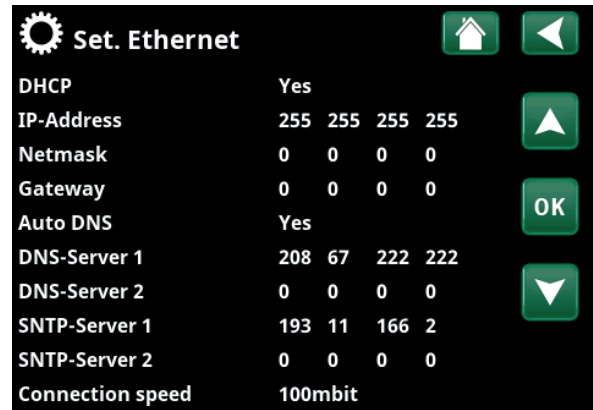

Menu: "Installer/Settings/Communication/Internet".

4.3.3.2 Settings BMS

MB address 1 (1...255)

Adjustable "1-255".

Baudrate 9600 (9600/19200)

Possible settings: "9600" or "19200".

Parity Even (Even/Odd/None)

Possible settings: "Even", "Odd" or "None".

Stop bit 1 (1/2)

Possible settings: 1 or 2.

Modbus TCP Port 502 (1...32767)

This menu bar is displayed if "Modbus TCP" is defined in the "Ethernet" in the "Installer/Define/Remote Control" menu.

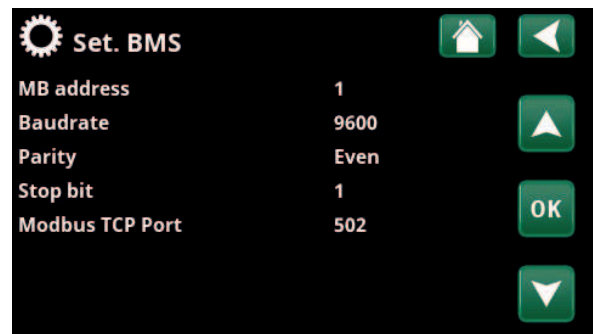

Menu: "Installer/Settings/Communication/BMS".

4.3.3.3 myUplink

The menu is used for pairing with the myUplink app. Request connection string by pressing "Get connection string", confirm with "OK". The menu bar is clickable if the display is connected to the server.

In the app: Scan the QR code or enter values for "Serial number" and "Connection string".

Select the menu items "Remove users" and / or "Remove service partners" to disconnect these accounts from the system. Confirm with "OK".



Menu: "Installer/Settings/Communication/myUplink".

4.3.3.4 Settings El. prices

Ensure that "myUplink" is selected in the "Def. Communication" menu.

Select "El.prices" in the "Installer/Settings/Communication" menu to access the "Set. El.prices" menu.

Price control On/Off

Select "On" to show the other menu lines of the "Set. El.prices" display menu.

Regions SE01/SE02/SE03/SE04

Click "OK" on the "Regions" line. If "Regions" are defined for the selected country (see "Installer/Display/Country" menu), price regions for the country are shown here. Otherwise, the text "No regions available" is displayed. In this example, Swedish price regions are displayed.

Dynamic Yes/No

"Yes" means that the electricity prices are calculated according to price algorithms that define the price categories ("High", "Medium" and "Low").

Click "OK" on the "Preview data" line to display a graph of electricity prices calculated over the selected time interval ("Days in calculation").

The graph can also be displayed by clicking the "El.prices" icon in the "Operation" main menu (see "Operation" section).

Limit value high

Set the limit value above which the electricity price is defined as "High" (in the example, the limit value is SEK 3.50). This can be used together with the dynamic price calculation feature to define a different "High" price range than that determined by the dynamic price calculation feature.

Prices defined as "High" activate the "SmartGrid Blocking" function.

Limit value low

Set the limit value below which the electricity price is defined as "Low" (in the example, the limit value is SEK 1.50). This can be used together with the dynamic price calculation feature to define a different "Low" price range than that determined by the dynamic price calculation feature.

Prices defined as "Low" activate the "SmartGrid Low price" function.

Default High/Medium/Low

Select the price category that should apply if prices cannot be retrieved.



Menu: "Installer/Settings/Communication/El.prices" where "Installer/Define/Communication/myUplink:Yes" is selected.

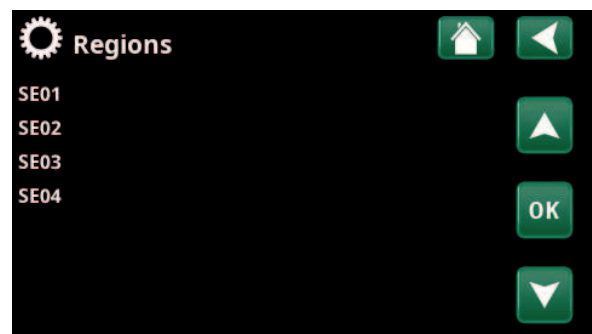

Menu: "Installer/Settings/Communication/El.prices/Regions" where "Installer/Define/Communication/myUplink:Yes" is selected

For more information and examples of Smart Electricity Price Control/SmartGrid, see the website www.ctc-heating.com/Products/Download.

Days in calculation

1...10

Select the number of days on which the dynamic calculation of the electricity price will be based. Since the dynamic calculation is based on the average price per day, more days in calculation result in a more stable and reliable value.

See also the "Example: Electricity price settings" section.

Preview data

Click "Preview data" to show electricity prices during the selected period in graph form.

Offset %

0 (0...100)

Enter code "4003" in the "Installer/Service/Coded settings/Code" menu to display the "Offset %" menu line.

"Offset" is the boundary between where "High" price and "Medium" price electricity is determined and is based on the average price for the number of days used in the calculation.

See also the "Example: Electricity price settings" section.

Width %

50 (0...200)

Enter code "4003" in the "Installer/Service/Coded settings/Code" menu to display the "Width %" menu line.

"Width" is the vertical price range where the electricity price is considered "Medium".

See also the "Example: Electricity price settings" section.

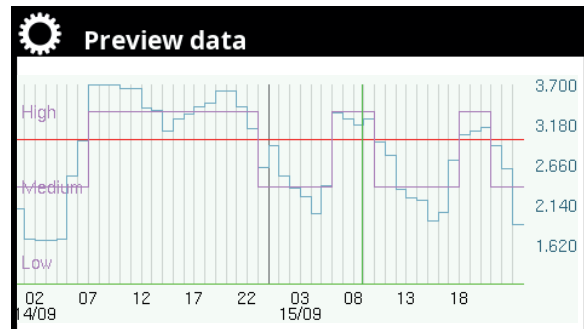

Menu: "Installer/Settings/Communication/El.prices/Preview data".

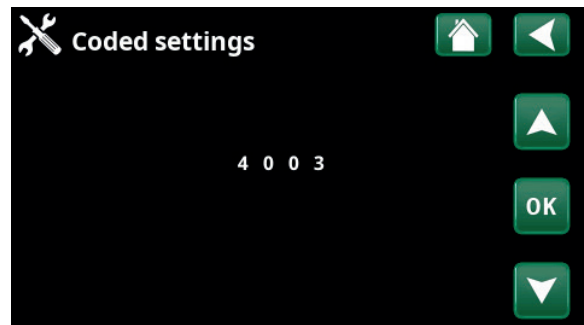

Menu: "Installer/Service/Coded settings/Code".

4.3.4 Save settings

Custom settings can be saved to "Bank" 1-3 and on a USB drive here. The "USB" row is greyed out until the USB drive is installed. The rows show the date and time of saved settings.

Press "OK" to confirm.

4.3.5 Load settings

The saved settings can be recovered.

Press "OK" to confirm.

4.3.6 Load Factory settings

The product is supplied with the factory values set. Saved settings in "Bank" 1-3 are deleted when factory settings are restored. The selected language is recovered.

Press "OK" to confirm.

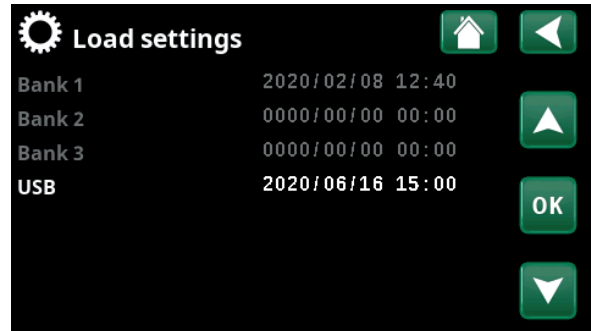

Menu: "Installer/Settings/Load My Settings".



4.4 Define

4.4.1 Def. Remote control

Remote control is defined by setting a normal mode for the external control signal with the "NO" (Normally Open) or "NC" (Normally Closed) options.

For example, the control signal can be generated by a two-position switch. If, when used, the switch generates a control signal on the input (circuit closes), the circuit shall be defined as NO.

External control NO/NC/DHW NO/DHW NC/BMS

Set whether the heat pump, with external control, should charge the DHW tank or heating tank or whether external control should be applied via BMS.

- **NO/NC:** When the circuit is closed (at normal mode NO), the temperature to the external heating tank set in the "Installer/Settings/Heating Circuit/Ext. control temp °C" menu is activated (factory setting 30 °C).
DHW NO/DHW NC: When the circuit is closed (at normal mode DHW NO), the temperature to the external DHW tank set in the "Installer/Settings/Heating Circuit/Ext. control temp DHW °C" menu is activated (factory setting 30 °C).
- **BMS**
External control applied via BMS. Define settings for BMS in the "Installer / Define / Communication" menu.

Ethernet Off/Modbus TCP

For information about Modbus TCP Port settings, refer to the "Communication" section in the "Installer / Settings" chapter.

4.4.2 Def. Communication

MyUplink No (Yes/No)

Select "Yes" to connect to the heat pump from the MyUplink app.

Web No (Yes/No)

Select "Yes" to connect to the local web server. Internet router and firewall required.

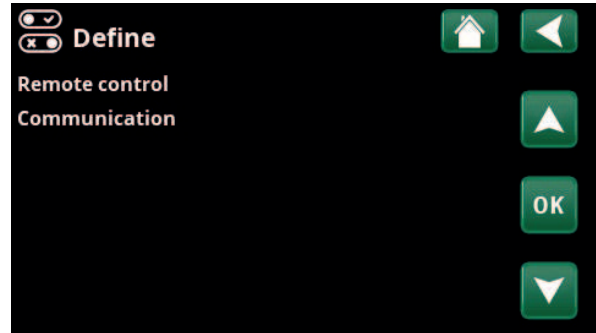

Menu: "Installer / Define / Remote Control".

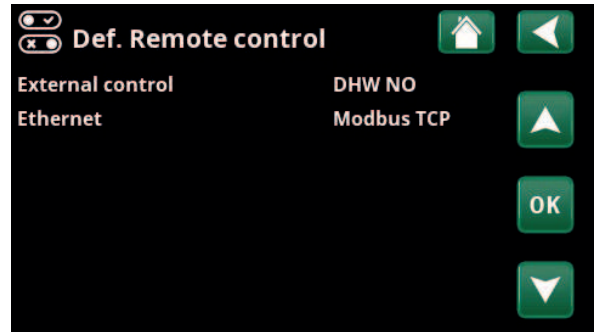

Menu: "Installer / Define / Remote Control".

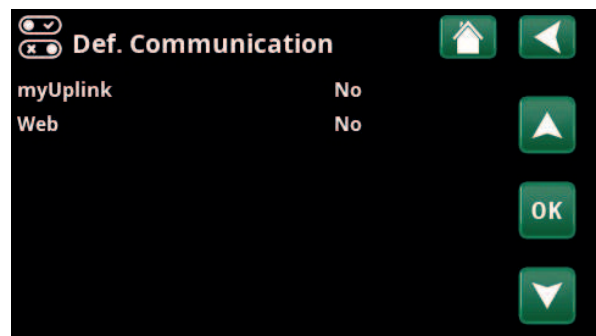

Menu: "Installer / Define / Communication".



4.5 Service



NB: This menu is intended for the installer only.

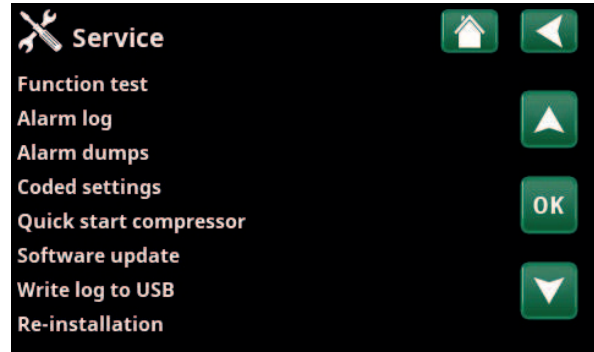

Menu: "Installer / Service".

4.5.1 Function test

From this menu, the installer can test the connection and function of separate heat pump components. When this menu is activated, all control functions cease. The heat pump returns to normal operation after 10 minutes of inactivity or when exiting the "Function Test" menu.



When you exit the menu, the heat pump returns to normal operation.

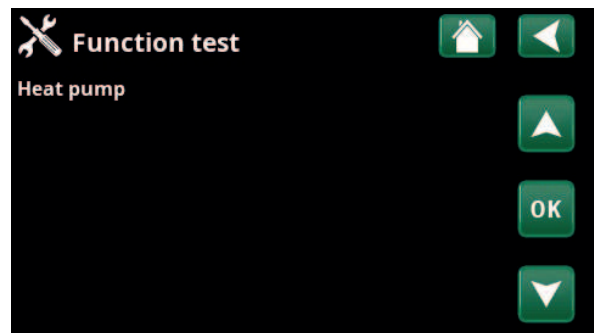

Menu: "Installer / Service/ Function Test".

4.5.1.1 Test Heat pump

HP Compressor **Off (On/Off)**

When the compressor is being function tested, the brine and charge pump are also operating so that the compressor does not trigger its pressure switches.

HP Brine Pump /Fan **Off (Off/On)**

Function test brine pump or fan (air-to-water HP).

HP Charge pump **0 (0...100%)**

Function test charge pump 0-100%.

Defrost Manually **Off (Off/On)**

When the "Manual defrosting" function is tested, a defrosting cycle will be performed in the air-to-water heat pump. Defrosting cannot be stopped once it has been started and the defrosting programme will be completed.

Compressor heat **Off (Off/On)**

Function test compressor heater.

Drip tray heater **Off (Off/On)**

Function test of the condenser tray heater.

Heating Cable **Off (Off/On)**

Function test heating cable.

4-way valve (Y11) **Off (Off/On)**

Function test 4-way valve (Y11). Fitted to air/water HP.

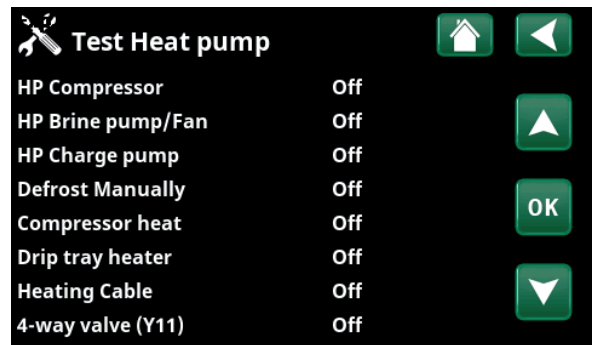

Menu: "Installer / Service/ Function Test / Heat Pump".

4.5.2 Alarm log

In the alarm log, up to 500 alarms can be displayed at the same time.

An alarm which reoccurs within an hour is ignored so as not to fill up the log.

Click an alarm row to see more information about an alarm.

If it is a "sensor alarm", a sensor value will be displayed at the bottom of the page from when the alarm was triggered for further troubleshooting.

For alarms related to the heat pump, values can be displayed from sensors for pressure (HP, LP), temperature (SH=Superheating) and current (I).

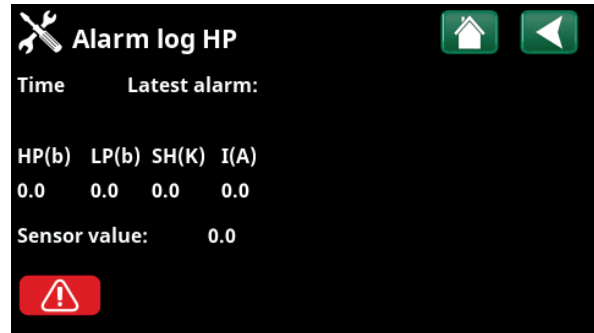

Menu: "Installer/Service/ Alarm log".

! NB: Only an authorised service engineer is allowed to log in to the Factory settings coded option. Severe operational problems and faults may occur affecting the product if values are amended without authorisation. Note that in such cases the warranty terms do not apply.

4.5.3 Alarm dumps

Export the alarms displayed in the alarm log to a USB drive. A dump can consist of one or more alarms as well as specific values before and after the alarm was triggered.

4.5.4 Coded settings

This menu is intended to set the manufacturer's operational and alarm limits. A 4-digit code must be specified to be able to amend these limits. However, you can also look without any code to see what options feature in the menu.

4.5.5 Quick start compressor

The delay normally prevents compressor start earlier than 10 mins after compressor stop. The delay is also activated in the event of a power failure, or the first time after production is started. This function speeds up this process.

For "System Types" 1 to 3, the degree minute loss is set to the value that starts all heat pumps.



Menu: "Installer/Service/Alarm Dumps".

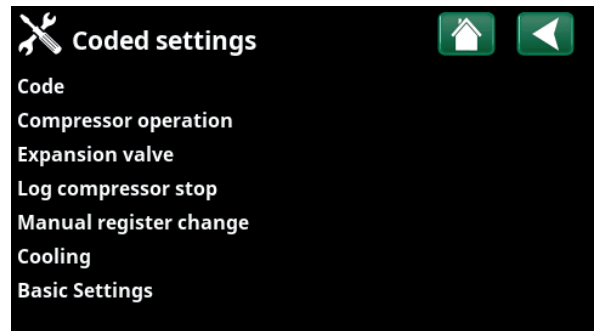

Menu: "Installer/Service/Coded settings".

4.5.6 Software update

The display software can be updated either via USB drive or online. The rows are greyed out until the USB drive is installed or the display is connected to the internet.

Click OK to confirm the upload.

The settings are retained during updating, but the old values are overwritten by any new factory values.

4.5.7 Write log to USB

Intended for service engineers. This function can be used to save logged values to a USB memory stick.

4.5.8 Re-installation

This command relaunches the installation sequence. First, confirm that you want to reinstall to access the installation wizard, refer to the "Installation Guide" and "First Start" chapters.

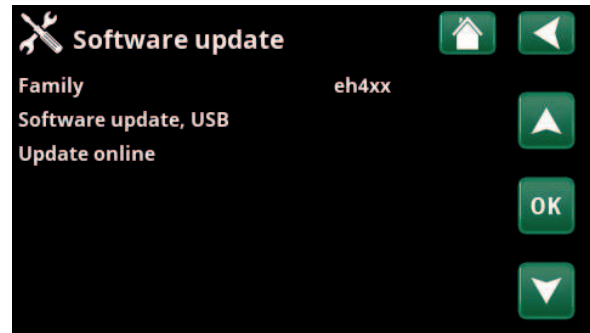

Menu: "Installer/Service/ Software Update".

! NB: The power to the product must not be interrupted, under any circumstances, during the update process.

! NB: Turn off the power and always restart the product after software update. Several minutes may pass before the display communicates clearly after restart.

5. Parameter list EcoLogic S

	Factory setting	Personal settings
Heating Circuit		
Max primary flow °C	55	
Min primary flow °C	14	
HP max DHW	No	
Ext. control temp °C	30	
Ext. control temp DHW °C	30	
Heat pump		
Compressor	Blocked	
Stop at outdoor temp °C	-22	
Charge pump %	50	
Cold temp limit	0	
Max RPS	90	
Warm temp limit	20	
Max RPS warm temp	50	
Compressor stop at brine °C	-5	
Brine pump	Auto	
Communication		
Internet		
DHCP	Yes	
Auto DNS	Yes	
SNTP server		
Connection speed	10mbit	
BMS		
MB address	1	
Baud rate	9600	
Parity	Even	
Stop bit	1	
Modbus TCP Port	502	

6. First start

6.1 Before first start

1. Check that the system is filled with water, purged and has the correct pressure, and that there is no leakage. Air in the system (poor circulation) can, for example, mean that the heat pump is tripped by its high pressure protection.
2. Check that all electrical cables and sensors are correctly installed and connected. See section "Electrical installation".
3. Check that the heat pump is switched on.
4. Check that the CTC EcoEl electric boiler (if connected) has been correctly connected to the system.

6.2 First start

Turn on the power with the safety switch. The display will switch on. When starting up the system and during reinstallation (refer to the "Installer / Service" chapter), a number of system options must be selected. The dialogue boxes which will then be displayed are described below.

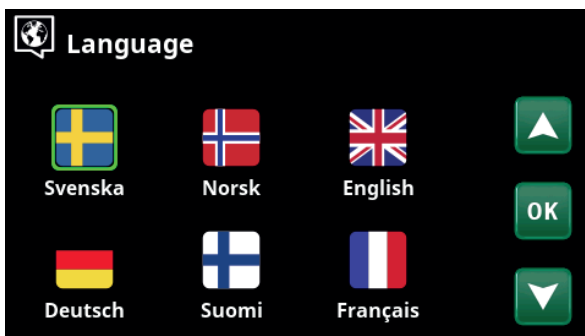

1. Choose language. Confirm with "OK".



2. Select the country where the installation is located. Confirm with "OK".

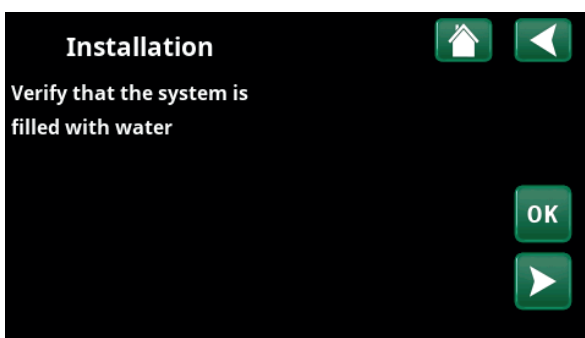

2. Verify that the system is filled with water Confirm with "OK" and the "right" directional arrow.

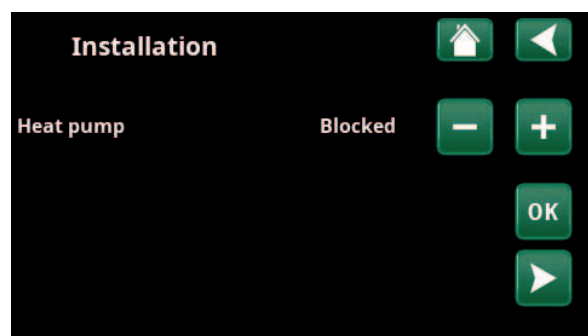

3. Specify whether Heat pump 1 is permitted or blocked. For "Permitted" press plus (+). For "Blocked" press minus (-). Confirm with the "right" directional arrow.

7. Operation and Maintenance

When the installer has installed your new heat pump, you should check along with the installer that the system is in perfect operating condition. Let the installer show you where the switches, controls and fuses are so that you know how the system works and how it should be maintained.

8. Troubleshooting/Appropriate measures

CTC EcoLogic is designed to provide reliable operation and high levels of comfort, and to have a long service life. Various tips are given below which may be helpful and guide you in the event of an operational malfunction. If a fault occurs, you should always contact the installer who installed your unit. If the installer believes the malfunction is due to a materials or design fault, then they will contact us to check and rectify the issue. Always provide the product's serial number.

Ground loop

Faults can occur in the cooling unit if the ground loop has not been installed correctly, if it has not been bled sufficiently, if it contains too little antifreeze or is not designed to an adequate size. Poor or insufficient circulation can result in the heat pump triggering an alarm in the case of low evaporation. If the temperature difference between the ingoing and outgoing temperature is too large, the product triggers an alarm and "Low brine flow" is displayed. The probable cause is that there is still air in the brine circuit. Bleed thoroughly, which may in some cases take up to a day. Also check the ground loop. See also the section entitled "Connecting the brine system".

Check:

- that the brine pump speed value is not set too low. Try to increase this if a problem arises.

Reset the "Low evaporation" alarm on the display. Where a malfunction repeatedly occurs, call in a technician to investigate and rectify the fault.

If the text "Low brine temp" is displayed, the ground loop may not be large enough or there may be a fault with the sensor. Check the brine circuit temperature in the "Current operation data" menu. If the incoming temperature falls below -5 °C during operation, call in a technician to inspect the brine circuit.

Motor protection

CTC EcoLogic constantly monitors the compressor's operating current and an alarm is triggered if the compressor is drawing an unusually high current. When a fault occurs, the message "Motor protect high current" is displayed.

The cause of the fault may be as follows:

- Phase failure or mains interruption. Check the fuses, which are the most common cause.
- Compressor overload. Call out a service engineer.
- Faulty compressor. Call out a service engineer.
- Circulation too poor between the cooling circuit and cylinder. Check the heat medium pump (charge pump).
- Abnormally high temperature in the brine circuit. Call out a service engineer.

8.1 Information messages

Information messages are displayed when appropriate and are intended to inform users about various operational situations.

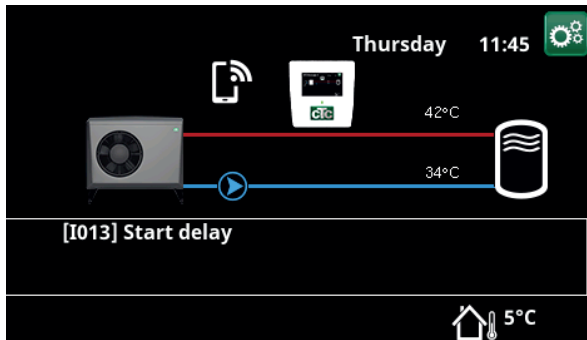

[I013] Start delay

The compressor is not allowed to start too quickly when it has stopped. The delay is usually at least 10 minutes.

[I009] Compressor blocked

The compressor is set to be shut down, e.g. before drilling or digging has been carried out for the collector coils. The product comes with the compressor switched off. This option is selected in the "Installer / Settings / Heat Pump" menu.

[I030] Driver block under voltage

The heat pump has stopped due to insufficient mains voltage. The product will attempt to restart.

[I031] Driver block alarm

The heat pump has stopped due to driver failure; for example, voltage or excessive temperature. The product will attempt to restart.

8.2 Alarm messages

If a fault occurs with e.g. a sensor, an alarm is triggered. A message appears on the display with information about the fault. In the event of an alarm, the LEDs on the display and room sensor also flash.

You reset the alarm by pressing the "Reset alarm" button on the display. If several alarms are triggered, they are displayed one after the other. A persisting fault must first be rectified before it can be reset. Some alarms are reset automatically if the fault ceases.

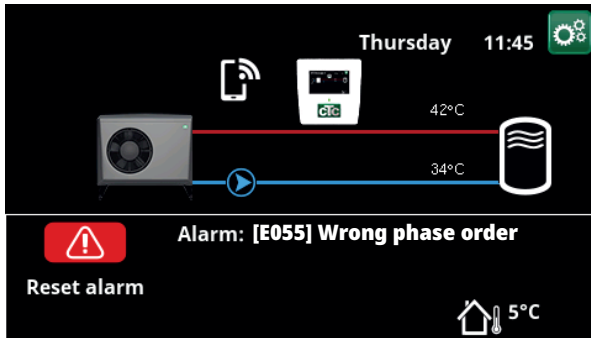

Alarm messages	Description
[E055] Wrong phase order	The product's compressor motor must rotate in the right direction. The product checks that the phases are connected correctly; otherwise, an alarm is triggered. This will require changing two of the phases into the product. The power supply to the system must be shut off when rectifying this fault. This fault generally only occurs during installation.
[Exxx] sensor	An alarm is displayed if a fault occurs with a sensor that is not connected or has short-circuited. If this sensor is significant to the system's operation, the compressor stops. This requires the alarm to be reset manually after the fault has been rectified. [E030] Outdoor sensor (B15) and for heat pump: [E003] Sensor brine in [E005] Sensor brine out [E028] Sensor HP in [E029] Sensor HP out [E036] Sensor high pressure [E037] Sensor discharge [E043] Sensor low pressure [E080] Sensor suction gas [E160] Sensor suction gas
[E057] Motor protect high curr.	High current into the compressor has been detected. Press reset and check whether the alarm recurs. If the fault recurs, contact your installer.
[E058] Motor protect low curr.	Low current into the compressor has been detected. Press reset and check whether the alarm recurs. If the fault recurs, contact your installer.
[E035] High pressure switch	The refrigerant's high pressure switch has been triggered. Press reset and check whether the alarm recurs. If the fault recurs, contact your installer.
[E041] Low brine temp	Incoming brine temperatures from bore hole/ground loop are too low. Press reset and check whether the alarm recurs. If the fault recurs, contact your installer to check the dimensions of the cold side.
[E040] Low brine flow	Low brine flow is often caused by air in the collector system, especially immediately following installation. Collectors which are too long can also be a cause. Check also that the brine pump is set to speed 3. Press reset and check whether the alarm recurs. Also check the brine filter that has been installed. If the fault recurs, contact your installer.

Alarm messages	Description
[E063] Comm. error relay card [E027] Communication error HP [E056] Comm. error motor protection	This message is displayed when the display card (A1) cannot communicate with the relay card. (A2) This message is displayed when the display card (A1) cannot communicate with the HP control card (A5). This message is displayed when the HP control card (A5) cannot communicate with the motor protection. (A4)
[E044] Stop, high compr temp	This message appears when the compressor temperature is high. Press reset and check whether the alarm recurs. If the fault recurs, contact your installer.
[E045] Stop, low evaporation	This message appears when the evaporation temperature is low. Press reset and check whether the alarm recurs. If the fault recurs, contact your installer.
[E046] Stop, high evaporation	This message appears when the evaporation temperature is high. Press reset and check whether the alarm recurs. If the fault recurs, contact your installer.
[E047] Stop, low suct. gas exp. valve	This message appears when the suction gas temperature is low. Press reset and check whether the alarm recurs. If the fault recurs, contact your installer.
[E048] Stop, low evapor.	This message appears when the expansion valve's evaporation temperature is low. Press reset and check whether the alarm recurs. If the fault recurs, contact your installer.
[E049] Stop, high evap. exp. valve	This message appears when the expansion valve's evaporation temperature is high. Press reset and check whether the alarm recurs. If the fault recurs, contact your installer.
[E050] Stop, low overheat exp. valve	This message appears when the expansion valve's superheat temperature is low. Press reset and check whether the alarm recurs. If the fault recurs, contact your installer.
[E013] EVO off	This message appears when there is a fault with the expansion valve control.
[E052] Phase 1 missing [E053] Phase 2 missing [E054] Phase 3 missing	This message appears in the event of a phase failure.
[E010] Compressor type?	This message appears if no information about the compressor type is available.
[E026] Heat pump	This message appears if the heat pump is in alarm mode.
[E001] Risk of freezing	Alarm indicating that the temperature of the outgoing water from the heat pump (HP out) is too low for defrosting. The water volume in the system may be too low. The flow may be too low. (Applies to EcoAir)
[E163] Defrost max time duration	The heat pump has not had time to complete defrosting within the maximum time. Make sure that any ice on the evaporator has disappeared.
[E087] Driver	Press reset and check whether the alarm recurs.
[E088] Driver: 1 - [E109] Driver: 29 Driver fault.	If the fault recurs, contact your installer and tell them the error code number where applicable.
[E117] Driver: Offline	Communication error. The electrical connection box and driver of the heat pump are not communicating.

8.3 Critical alarms - Risk of freezing



[E135] Risk of freezing (after four alarms, a new alarm is displayed [E218])

[E211] Risk of freezing low flow (after four alarms, a new alarm is displayed [E219])

[E216] HP flow temp diff (after four alarms, a new alarm is displayed [E220])

[E217] HP Charge pump flow (after four alarms, a new alarm is displayed [E221])

If a critical alarm is shown on the display, take the action described below. Confirm the alarm by entering code 4005 in the display menu "Installer/Service/Coded settings/Code".

Please note: The critical alarms can be acknowledged three times by entering code 4005. **After four alarms, the heat pump is blocked;** in this case, contact the installer. After one year of operation without any alarms, the critical alarms are reset.

! The critical alarms [E135], [E211], [E216] and [E217] can be acknowledged three times by entering code 4005. After four alarms, the heat pump is blocked.

[E135] Risk of freezing

Applies to all air/water heat pumps controlled by CTC EcoLogic L/M/S, CTC EcoZenith i255/i360/i555 and CTC EcoVent i360F.

Alarm conditions

If the temperature of the water exiting the heat pump (HP out) is lower than 15 °C during a defrost period or if there is more than 15 °C difference between HP in and HP out for more than 20 seconds.

Possible cause

- The circuit temperature and/or flow rate is too low.
- If the sensors (HP in and HP out) do not display the correct value, alarm [E135] can be generated. Check the temperatures using an external thermometer.

Action

- Ensure that the return flow of the heating circuit is at a minimum of 25°C during a defrost period. In the event of low temperature, contact the installer.
- Supplement with a volume tank.
- Check the circulation pump, dirt filter, pipe system and pipe size to ensure flow requirements are met.
- Check the sensors (HP in and HP out) and replace as required.

[E211] Risk of freezing low flow

Applies to CTC EcoAir 600 with the "Flow sensor" accessory installed.

Alarm conditions

The flow is less than 10 l/min (EcoAir 610/614) or 15 l/min (EcoAir 622) for more than 30 seconds during a defrost period.

Possible cause

- The circuit temperature and/or flow rate is too low.

Action

- Check the circulation pump, dirt filter, pipe system, pipe size and flow sensor to ensure flow requirements are met.

[E216] HP flow temp diff

Applies to CTC EcoAir 500/600.

Alarm conditions

The difference between HP in and HP out exceeds 12 °C in heat operation for more than 15 minutes.

Possible cause

- The circuit temperature and/or flow rate is too low.

Action

- Check the dirt filter, pipe system and speed settings of the circulation pump to ensure flow requirements are met.
- Check the sensors (HP in and HP out) and replace as required.

[E217] HP Charge pump flow

Applies to CTC EcoAir 400.

Alarm conditions

The charge pump speed exceeds 70% during heat operation for more than 15 minutes.

Possible cause

- The circuit temperature and/or flow rate is too low.

Action

- Check the dirt filter, pipe system and speed settings of the circulation pump to ensure flow requirements are met.

9. Electrical installation

The installation must be carried out in accordance with the applicable standards.

Installation and connections in CTC EcoLogic must be performed by a licenced electrician. All wiring shall be installed according to applicable local requirements.

9.1 Power supply

24V DC

EcoLogic is powered by the heat pump via a supplied communication cable. Power supply and communication are routed through a shared cable.

9.2 Communication between EcoLogic and EcoAir/EcoPart

LiYCY (TP) is used as a communication cable. The cable is 4-core shielded cable, where the communication cores are of twisted pair type. The display (A1) is connected to the heat pump circuit board (A5) according to the wiring diagram "Connecting control card EcoAir/EcoPart".

9.3 Outdoor sensor B15 (EcoPart)

Outdoor sensor (B15) connects to control card EcoPart on terminals U5 and GND, refer to wiring diagram "Connecting control card EcoAir/EcoPart".

9.4 Thermostat control K26 / Control signal external 3-way valve

Thermostat control K26 and control signal from external 3-way valve (when switching heating/DHW) connect to HP control card (A5) as follows:

EcoAir 400 / EcoPart 400 / EcoAir 500

Connection to terminal DI3 and GND (see wiring diagram "Connecting control card EcoAir/EcoPart").

EcoAir 600 / EcoPart 600

Connection to terminal DI1 and GND (see wiring diagram "Connecting control card EcoAir/EcoPart").

9.5 Connecting to terminal block and circuit board A5

The EcoLogic S can be connected to the heat pump circuit board via the terminal block as shown in the table below.

Remove the factory-fitted communication cable and connect the display/communication cable from EcoLogic S.

The fourth cable (yellow) must be connected to the circuit board via pin +V_{DC}.

Refer to the wiring diagram "Control card EcoAir/EcoPart connection".

Connecting EcoLogic S to terminal block (colour code)	Connecting terminal block to circuit board
B (brown)	RX-/TX-
A (white)	RX+/TX+
G (green)	GND

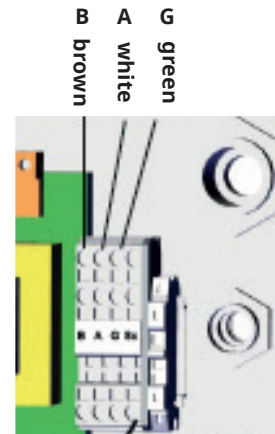

Connecting EcoLogic S to terminal block (EcoAir)

9.6 Connecting a separate communication cable

When connecting a separate communication cable to the heat pump, connect the RJ45 cable's colour-code ports to the pins on the circuit board as shown in the table below.

RJ45 cable connection	Circuit board connection
Position 7	+V _{DC}
Position 8	GND
Position 5	RX+/TX+
Position 4	RX-/TX-

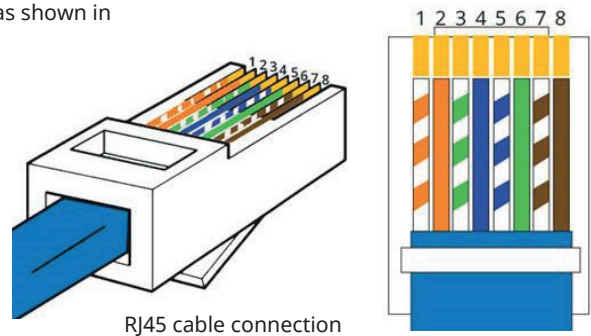

RJ45 cable connection

9.7 Connecting control card EcoAir/EcoPart

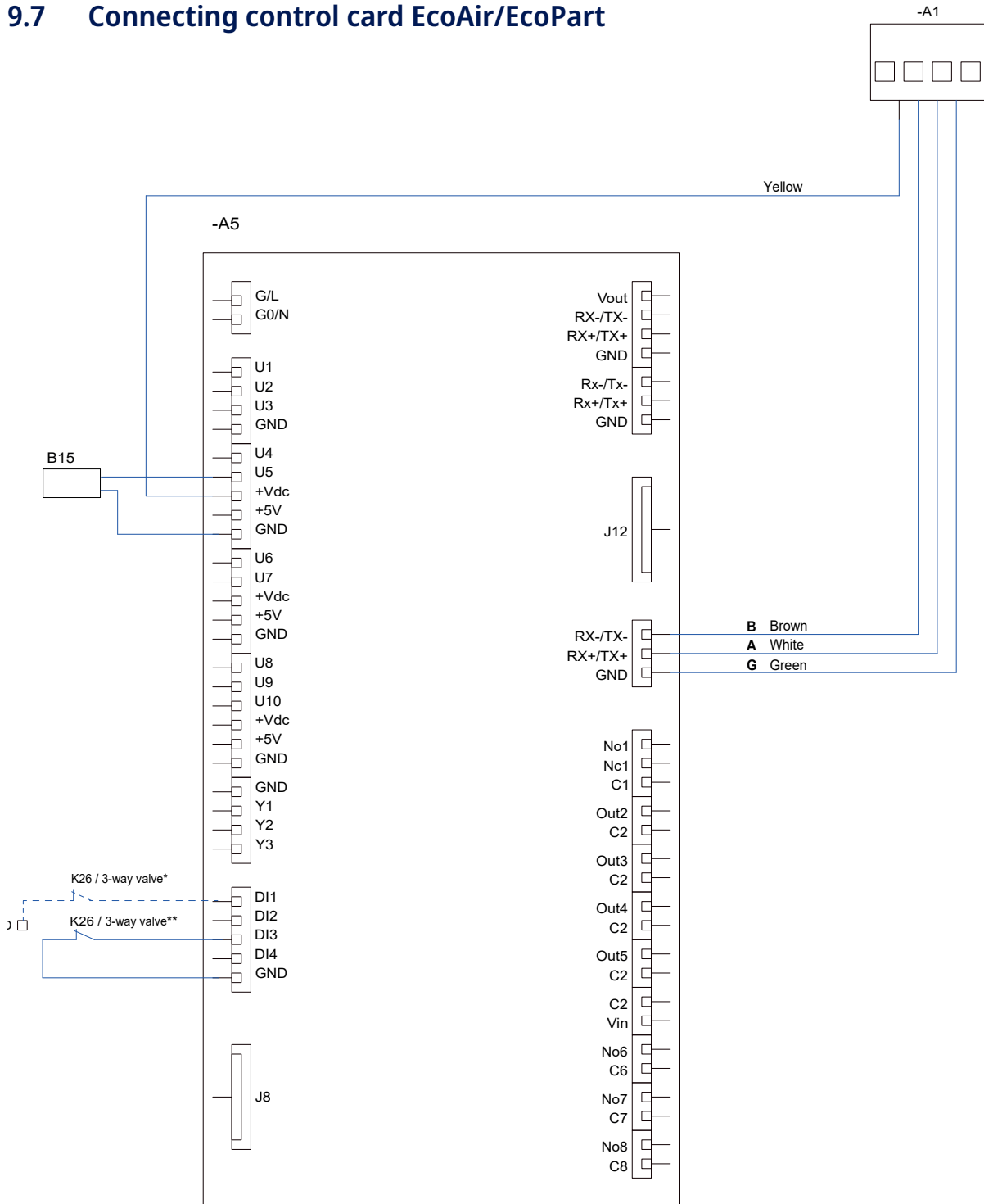

Designation	Component
A1	Display
A5	HP-control card
B15	Outdoor sensor (EcoPart)
K26 / 3-way valve*	Thermostat control / control signal 3-way valve (DI1+GND). Applies to control card EcoAir 600 / EcoPart 600
K26 / 3-way valve**	Thermostat control / control signal 3-way valve (DI3+GND). Applies to control card EcoAir 400 / EcoPart 400 / EcoAir 500

10. Installation Communication

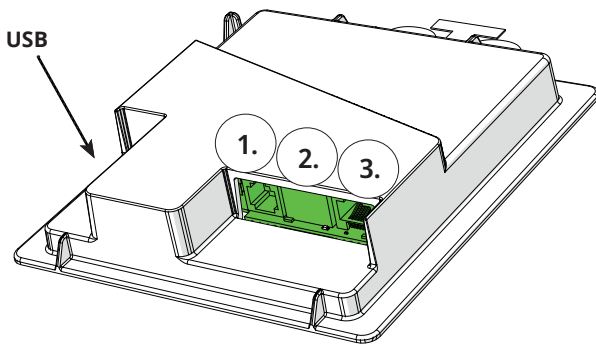

The back of the display unit has three communication ports.

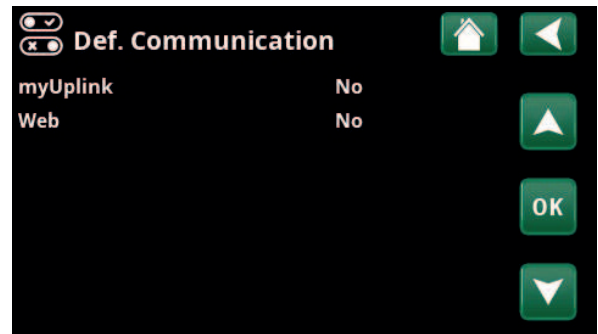

Menu: "Installer / Define / Communication".



Display communication ports

- 1. Port 1. RS485 port without galvanic protection. For external equipment, e.g. BMS

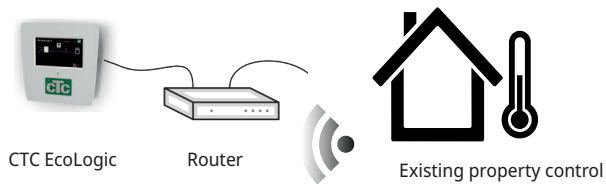

- 2. Port 2. Network jack (ethernet), see connection information on following page.

Define the app:

MyUplink: "Yes" enables connection to the app.

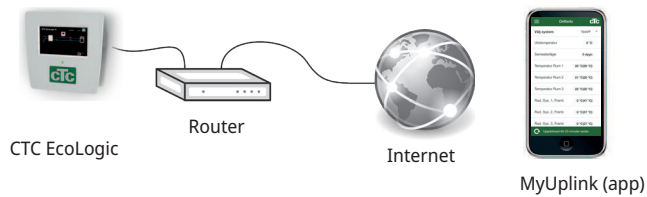

Define Web:

"Yes" permits network connection, the "CTC Remote" screen mirror feature and BMS function with remote control via network cable to local network.

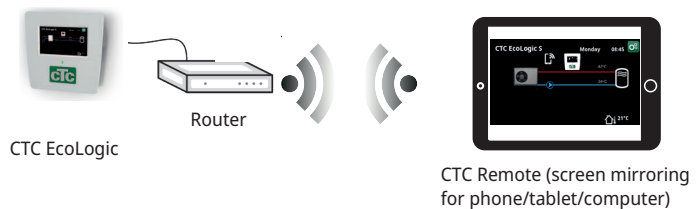

- 3. Port 3. Communication and power supply between EcoLogic S and heat pump.



10.1 Remote - Screen Mirroring

- Connect the ethernet cable, see previous page.
- Installer/Define/Communication/Web - Yes. Permits the product to connect with unencrypted web traffic on local area networks. Internet router and firewall required.
- Installer/i - Scan the QR code with a tablet or smartphone. 
- Save as favourite/icon on phone/tablet/computer. When your phone/tablet is connected to your local network, the product can be used with your device's touchscreen in the same way as the product's screen.
- In the app: scan QR code or enter address "http://ctcXXXX/main.htm". (XXXX = the last four digits of the display serial number, for example S/N 888800000040 = "http://ctc0040/main.htm"). In case of problems: click the link to update to the device's current IP no.

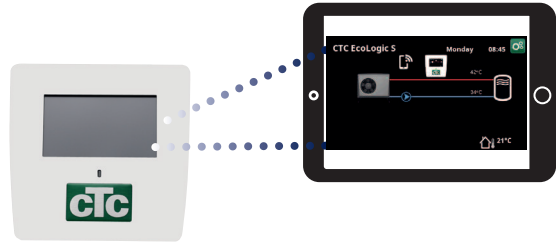

Tablet/Smartphone/PC as a touchscreen for local area network "Installer/Define/Communication/Web" - "Yes".

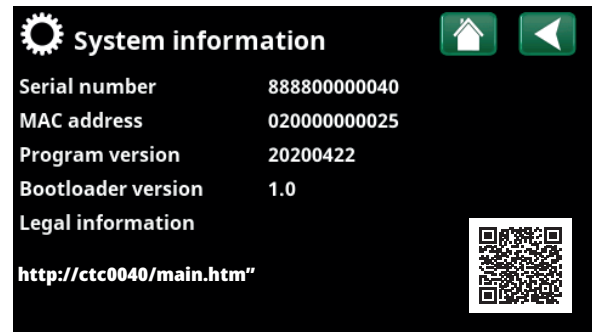

10.2 myUplink - App

Define myUplink. See "Installer/Define/Communication/myUplink - Yes".

Installing the app.

- Download myUplink from the App Store or Google Play.
- Create an account.
- Follow the instructions in the app's Help feature.

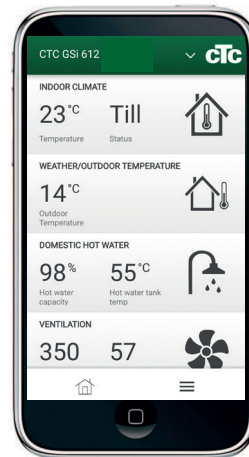

11. Appendix

11.1 Types of Operation with CTC EcoEI V2

This is a connection option where CTC EcoAir is connected to the CTC EcoEI V2 electric boiler.

11.1.1 Installation

- Turn off the power to the products.
- Close shut-off valves underneath CTC EcoEI.
- Disconnect the existing heat pump.
- Position the new heat pump in place according to its Installation and Maintenance Manual.
- Install the circulation pump and fit its supply cable and control cable to the heat pump according to the wiring diagram. The circulation pump is marked as G11 on wiring diagram.
- Connect the heat pump power supply to its own group fuse, refer to the heat pump's instructions.
- Install the display unit according to its installation instructions.
- Vent water pipes and open shut-off valves underneath CTC EcoEI.
- Turn on the power to the products.

11.1.2 Programming CTC EcoEI

CTC EcoEI is only programmed for an electric boiler.

- Hold the "D" button until the next menu is displayed
- If room temperature is displayed, press "D" again to display "LOG/DIAGNOSIS/INST/MANUAL" (see 1.)
- Press plus (+) to select "INST" (checked box)
- Press "D" 3 times until the box "ECOHEAT/ECOAIR/ECOEL/ECOKM" appears (2.)
- Press "+" until ECOEL is selected with a checked box.
- Press "D" until box "3." is selected.
Electric boiler lower "PERMITTED" and Temp Lower electric boiler "30 °C" is a basic setting not to outcompete the heat pump but activate the electric boiler in winter if the outdoor temperature is lower than the heat pump's lowest outdoor temperature. Other possible options:
 1. "ELECTRIC BOILER LOWER" "BLOCKED"/"TEMP LOWER ELECTRIC BOILER" "55 °C" The electric boiler is blocked in spring/summer/winter and the property owner permits the electric boiler to operate in winter if necessary.
 2. "MAX POWER ELECTRIC BOILER" "9 kW"+ "ELECTRIC BOILER LOWER" "BLOCKED". Recommended in cases where 9 kW is enough for the entire property and the outdoor temperature is rarely or never below -20 °C
- Note: "MAX POWER ELECTRIC BOILER" is adjustable 0/3/6/9 kW and "ELECTRIC BOILER LOWER" is 0/6 kW.

Make sure that there is sufficient electrical power for the property and that the group fuse/main fuse is adapted for the selected electrical power.

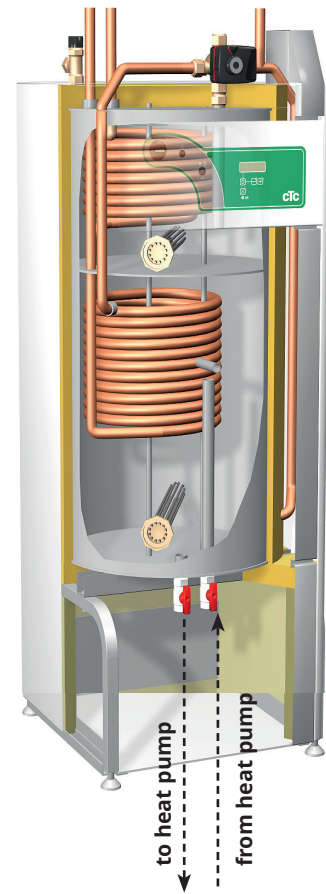

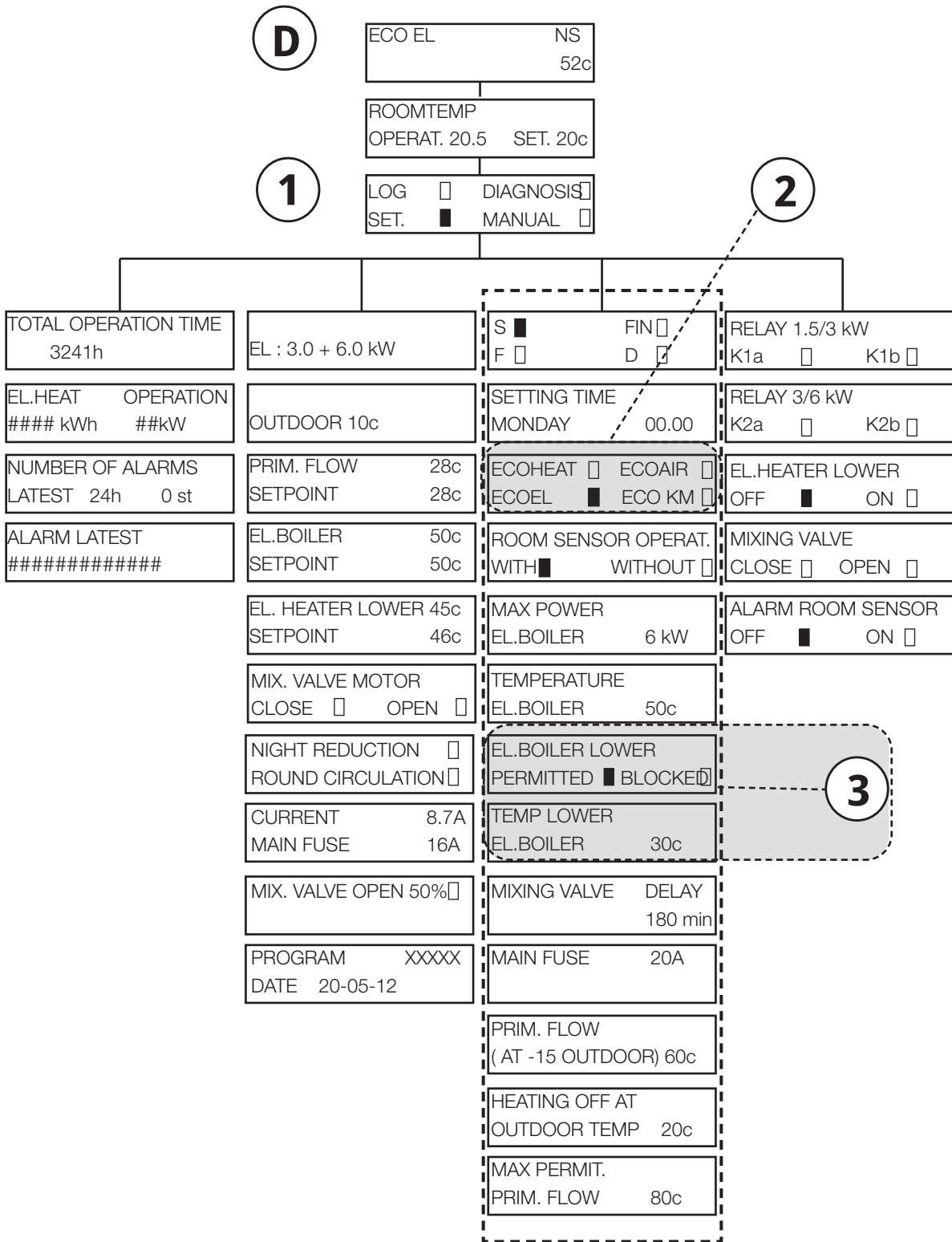

11.1.2.1 EcoEl v.3

The example below shows how to make changes in the "Settings" menu for EcoEl v.3:

- Press the arrow key until the cursor is at "Installer". Press OK.
- In the "Installer" menu: move the cursor to "Settings". Press OK.

To change the setting from "EcoAir" to "EcoEl":

- In the "Settings" menu: place the cursor on the "Product" menu bar. Press OK.
- Use the arrow key and select "EcoEl". Press OK.

To change the set point of the lower boiler:

- Move the cursor to the menu bar "Boiler lower °C". Press OK.
- Use the arrow key to set a different value. Press OK.

Make other changes in the same way in the "Settings" menu.

Settings	
Language	English
Product	EcoEl
Room sensor	Yes/No
Boiler °C	50
Boiler max kW	3
Boiler lower °C	30
Boiler lower kW	6
Main fuse A	20
External Control	NC
Settings house parameters	
Holiday	On/Off
Primary flow reduced °C	-2
HP max DHW	Yes
Save settings	
Load settings	
Load factory settings	

www.ctc.se, www.ctc-heating.com
+46 372 88 000
Fax: +46 372 86 155
P.O Box 309 SE-341 26 Ljungby Sweden



MADE IN SWEDEN