



Providing sustainable energy solutions worldwide

Installation and Maintenance Manual
CTC EcoZenith i250

400V 3N~/ 230V 1N~

IMPORTANT

READ CAREFULLY BEFORE USE
KEEP FOR FUTURE REFERENCE



CTC EcoZenith i250



Table of Contents

Checklist	7		
Important to remember!	8		
1. Your home's heating installation	11	9. Operation and Maintenance	63
2. Technical data	15	10. Troubleshooting/appropriate measures	64
2.1 Table 400V 3N~	15	10.1 Information messages	67
2.2 Table 230 V 1N~	16	10.2 Alarm texts	68
3. Measurements	17	11. Installation	71
4. CTC EcoZenith i250 design	18	11.1 Transportation	71
5. Parameter list	20	11.2 Unpacking	71
6. Control system	21	11.3 Standard delivery	71
7. Menu overview	22	Recycling	71
8. Detail Description Menus	28	12. Pipe installation	72
8.1 Start menu	28	12.1 Filling	72
8.2 Description of icons	28	12.1.1 Pressure drop in mixing valve	72
8.3 Room temp.	29	12.1.2 Pump curve charge pump	73
8.3.1 Setting a room temp. without a room sensor	29	12.2 Schematic diagram	74
8.3.3 Night reduction temperature	30	12.3 Connection to heat pump	77
8.3.2 Outdoor Sensor/Room Sensor Faults	30	12.4 DHW system	79
8.3.4 Holiday	31	12.5 Schematic diagram cooling	
8.4 DHW	31	-Common Heating and Cooling	80
8.4.1 Weekly program DHW	32	12.6 Schematic diagram cooling	81
8.5 Operation data system	33	13. Energyflex	82
8.5.1 Operation data EcoZenith	34	14. Electrical installation	85
8.5.2 Operation Heating circuit	35	14.1 Electrical installation 400 V 3N~	85
8.5.3 Stored operation data	36	14.2 Electrical installation 230V 1N~	85
8.5.4 Heat pump	36	14.3 Positioning of electrical components	86
8.5.5 Operation data heating	37	14.4 Electrical connection to heat pump	87
8.6 Installer	38	14.4.1 Communication	87
8.6.1 Time/Language	38	14.4.2 Heat pump power supply 400 V 3N~	88
8.7 Settings	39	14.4.3 Heat pump power supply 230V 1N~	88
8.7.1 Heating circuit 1 or 2	39	14.4.4 Connecting the heat pump connector	88
8.7.2 Set. heat pump	43	14.5 Extra low voltage protection	89
8.7.3 Electric heater	44	14.5.1 Current sensor connection	90
8.7.4 Upper tank	45	14.5.2 Terminal boards	91
8.7.6 Cooling (accessory)	46	14.6 Settings made by the installation electrician.	92
8.7.7 Solar panels (accessories)	46	14.7 Installing a backup power supply	92
8.7.5 Communication	46	14.8 Switching to 18 kW electric heater power.	93
8.7.8 Sett. Diff thermostat function	47	14.9 Connection of pump (G46) to Diff. therm. func.	95
8.7.9 Pool	47	14.10 Connection of sensor (B46) to Diff. therm. func.	95
8.7.10 Saving and loading settings	47	14.11 Wiring diagram 3x400 V	96
8.8 Define system	48	14.12 Wiring diagram 1x230 V	98
8.8.1 Def heating circuit 1 or 2	48	14.13 Component list, wiring diagram	100
8.8.2 Define SMS (accessory)	49	14.14 Resistances for sensors	101
8.8.3 Define cooling (accessory)	49	15. Connection of CTC EcoAir 500M heat pump	102
8.8.4 Def Solar panels	50	15.1 Menu functions unique to the CTC EcoAir 500M103	
8.8.5 Define Differential thermostat function	50	15.1.1 Operation data heat pump	103
8.8.6 Def. Pool	50	15.1.2 Heat pump Settings	104
8.8.7 Define CTC SmartControl (accessory)	50	15.1.3 Heat pump Settings continued	105
8.8.8 Define Remote Control	51	15.1.4 Set Schedule Noise reduction	106
8.9 Service	59	16. First start	107
8.10 Function test	59		
8.11 Alarm log	61		

Congratulations on your new product



You have just bought a CTC EcoZenith i250, which we hope you will be very pleased with. In the following pages you can read about how to operate and maintain your boiler.

Keep this manual containing the installation and maintenance instructions. If it is properly maintained, you will be able to enjoy the use of your CTC EcoZenith i250 for many years. This manual will provide all the information you will need.

The complete system tank

The CTC EcoZenith i250 is a complete system tank which meets your home's heating and hot water requirements. It has a built-in immersion heater giving a total of 15 kW and is equipped with a motorised mixing valve which ensures correct and even temperatures are supplied to your heating system. The CTC EcoZenith i250 has a built-in circulation pump for connection to a heat pump.

CTC EcoZenith i250 is only approved for installation in a package with the heat pumps

- CTC EcoAir 610M
- CTC EcoAir 614M
- CTC EcoAir 622M*
- CTC EcoAir 406
- CTC EcoAir 408
- CTC EcoAir 410
- CTC EcoAir 510M
- CTC EcoAir 520M*
- CTC EcoPart 40 6
- CTC EcoPart 408
- CTC EcoPart 410
- CTC EcoPart 412*

Eco design information about the current combination (current package) can be retrieved/downloaded from www.ctc.se/ecodesign where the energy labelling stickers can also be printed.

**Consider the flow requirements, particularly with the CTC EcoAir 622M, CTC EcoAir 520M and CTC EcoPart 412 models. See also the "Exact Primary Flow" function and use a larger circulation pump if required.



Information and energy labelling stickers must be handed over to the final consumer for the package in question

All controls for the heat pump and charge pump are built into the CTC EcoZenith i250. With this added feature you achieve a very eco-friendly and energy-saving heating system.

For more information, please see the separate section in this manual.

The CTC EcoZenith i250 has a control system that:

- Monitors all system tank, heat pump and heating system functions
- Permits individual settings
- Displays desired values, such as temperatures, operation times, energy consumption and fault signals
- Facilitates the setting of values and troubleshooting in a simple and well-structured way

The built-in copper coil provides copious amounts of hot water. The CTC EcoZenith i250 also has a so-called summer-time basement heating function and a floor heating block, which maximises the temperature supplied to the floor circuits. Using the integrated night reduction function, you can set and change the temperature in the house during the day, from one day to the next.

Easily accessible electrical components, along with effective troubleshooting functions in the control program, make the CTC EcoZenith i250 easy to service. It comes with a room sensor as standard, which is equipped with an LED which flashes in the event of a fault.

If you want to supplement your CTC EcoZenith i250 with other heating, you can do this easily thanks to two unique connections. We have decided to call this option Energyflex. With Energyflex you can, for example:

- Charge your heating system with solar energy
- Allow a water-jacketed stove to contribute heat
- Connect a pool exchanger to heat up a swimming pool

Checklist

The check list must be completed by the installer.

- In the event of a service, this information may be called for.
- Installation must always be done according to the installation and maintenance instructions.
- Installation must always be carried out in a professional manner.
- Following installation, the unit must be inspected, functional checks performed and the customer informed.

The points below should be checked off.

Pipe installation

- CTC EcoZenith i250 filled, positioned and adjusted in the correct manner according to the instructions.
- CTC EcoZenith i250 positioned so that it can be serviced.
- Capacity of circulation pump(s) for required flow.
- Open radiator valves and other relevant valves.
- Tightness test.
- Bleeding and pressurising the system.
- Safety valve function test.
- The waste pipe is connected to the draining gutter.

Electrical installation

- Power switch
- Correct tight wiring
- Primary flow sensor, return sensor + any required sensors for chosen system
- Outdoor sensor
- Room sensor (optional)
- Accessories
- Heat pump activated and started
- Electric power and fuse, adapted for the property, in normal operation and with backup power supply

Information for the customer (adapted to current installation)

- Start-up with customer/installer.
- Menus/controls for selected system
- Installation and maintenance manual supplied to the customer
- Check and filling, heating system
- Trimming information, heat curve
- Alarm information
- Mixing valve
- Safety valve function test
- Information on procedures for fault registration

Date / Customer

Date / Installer

Important to remember!

Check the following in particular on delivery and installation:

- The product must be transported and stored in an upright position. When moving the product, it can be placed temporarily on its back.
- Remove the packaging and check before installation that the product has not been damaged in transit. Report any transport damage to the carrier.
- Place the product on a solid foundation, preferably made of concrete. If the product is to stand on a soft carpet, plates must be placed under the feet.
- Remember to leave a service area of at least 1 m in front of the product.
- The product must not be placed below floor level either.

Safety instructions



Turn off the power with an omnipolar switch before doing any work on the product.



The product must be connected to protective earth.



The product is classified as IPX1. The product must not be rinsed with water.



When handling the product with a hoist ring or similar device, make sure that the lifting equipment, eyebolts and other parts are not damaged. Never stand under the hoisted product.



Never jeopardise safety by removing bolted covers, hoods or similar.



Any work on the product's cooling system should be carried out by authorised personnel only.



The product's electrical systems should only be installed and serviced by a qualified electrician.

-If the supply cord is damaged, it must be replaced by the manufacturer, its service agent or similarly qualified persons in order to avoid a hazard.



Safety valve check:

-Safety valve for boiler/system to be checked regularly.



The product must not be started if it is not filled with water; instructions are in the "Pipe installation" section.



WARNING: Do not switch on the product if there is a possibility that the water in the heater is frozen.



This device can be used by children from the age of eight years and above and by people with reduced physical, sensory or mental ability or lack of experience or knowledge if they have been taught, either with supervision or with the instructions provided, how to use the device safely and understand the risks involved. Children should not play with the device. Cleaning and maintenance should not be carried out by children without supervision.



If these instructions are not followed when installing, operating and maintaining the system, Enertech's commitment under the applicable warranty terms is not binding.



If these instructions are not followed when installing, operating and maintaining the system, Enertech's commitment under the applicable warranty terms is not binding

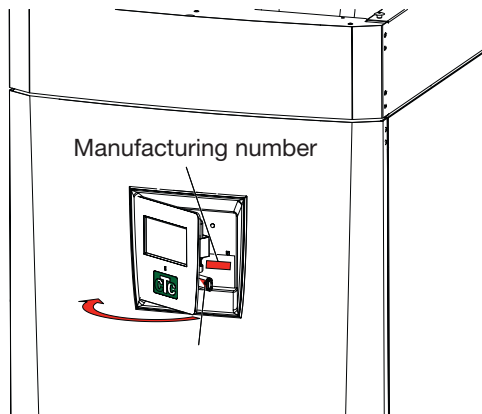

Information for the property owner to note	
Complete the fields below. This information is useful if any servicing work is required	
Product :	Manufacturing number:
Product :	Manufacturing number:
Installation company	Tel. no.
Date	Name
Electrical installation company	Tel. no.
Date	Name

No liability is accepted for any misprints or changes.

1. Your home's heating installation

The House Heating Curve

The heating curve is the central part of the product's control system. It is the heating curve which determines the compensated flow temperature requirements for your property dependent upon the outdoor temperatures. It is important that the heating curve is correctly adjusted, so that you achieve the best operation and economy possible.

One property requires a radiator temperature of 30 °C when the outdoor temperature is 0 °C, whilst a different property requires 40 °C. The difference between different properties is determined by the radiator surface area, the number of radiators and how well insulated the house is.

■ The set heating curve always takes priority. The room sensor can only increase or decrease the heat beyond the set heating curve to a certain extent. Where operating without a room sensor, the selected heating curve determines the flow temperature supplied to the radiators.

Adjustment of Default Values for the Heating Curve

You define the heating curve yourself for your property by setting two values in the product control system. This is achieved by selecting the options Inclination or Adjustment under the Installer/Settings/Radiator system menu. Ask your installer to help you set these values.

It is extremely important to set the heating curve and, in some cases, unfortunately, this process may take several weeks. The best way of doing this, upon the initial start-up, is to select operation without any room sensor. The system then operates using the outdoor temperature reading and the property's heating curve only.

During the adjustment period it is important that:

- the night reduction function is not selected.
- all thermostat valves on the radiators be fully opened. (This is to find the lowest curve for the most economical use of the heat pump.)
- the outdoor temperature is not higher than +5 °C. (If the outdoor temperature is higher when the system is installed, use the factory set curve until the outdoor temperature falls to a suitable level.)
- the radiator system is operational and correctly adjusted between different circuits.

Appropriate Default Values

During installation you can seldom achieve a precise setting for the heating curve instantly. In this case, the values given below may provide a good starting point. Radiators with small heat-emission surfaces require a higher primary flow temperature. You can adjust the gradient (heating curve gradient) for your heating system under the Installer/Settings/Radiator system menu.

Recommended values are:

Floor heating only	Inclination 35
Low temperature system (well insulated houses)	Inclination 40
Normal temperature system (factory setting)	Inclination 50
High temperature system (older houses, small radiators, poorly insulated)	Inclination 60

Adjusting the heating curve

The method described below can be used to adjust the heating curve correctly.

Adjustment if it is too cold indoors

- If the outdoor temperature is **lower** than 0 degrees:
Increase the Inclination value by a couple of degrees.
Wait 24 hours to see if any further adjustment is required.
- If the outdoor temperature is **higher** than 0 degrees:
Increase the Adjustment value by a couple of degrees.
Wait 24 hours to see if any further adjustment is required.

Adjustment if it is too warm indoors

- If the outdoor temperature is **lower** than 0 degrees:
Decrease the Inclination value by a couple of degrees.
Wait 24 hours to see if any further adjustment is required.
- If the outdoor temperature is **higher** than 0 degrees:
Decrease the Adjustment value by a couple of degrees.
Wait 24 hours to see if any further adjustment is required.

■ If the values set are too low, this may mean that the desired room temperature is not being reached. You then need to adjust the heating curve, as necessary, following the method shown above.
When the basic values have been set more or less correctly, the curve can be finely adjusted directly using the Room temp. shown on the home menu screen.

Examples of Heating Curves

You can see in the diagram below how the heating curve changes with different inclination settings. The gradient of the curve shows the temperatures that the radiators require at different outdoor temperatures.

Curve Inclination

The inclination value which is set is the primary flow temperature when the outside temperature is -15°C .

Adjustment

The curve can be parallel displaced (adjusted) by the desired number of degrees to adapt to different systems/ houses.

Inclination 50°C
Adjustment $+5^{\circ}\text{C}$

Inclination 50°C
Adjustment 0°C

An example

Inclination 60°C
Adjustment 0°C

In this example, the maximum outgoing primary flow temperature is set at 55°C .

The minimum permitted primary flow temperature is 27°C (e.g. summer-time basement heating or the floor circuits in a bathroom).

Primary Flow Temperature

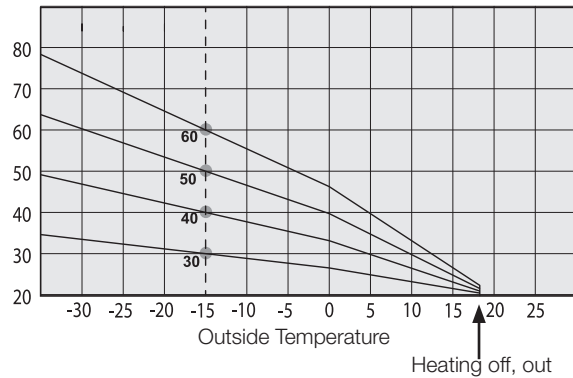

Primary Flow Temperature

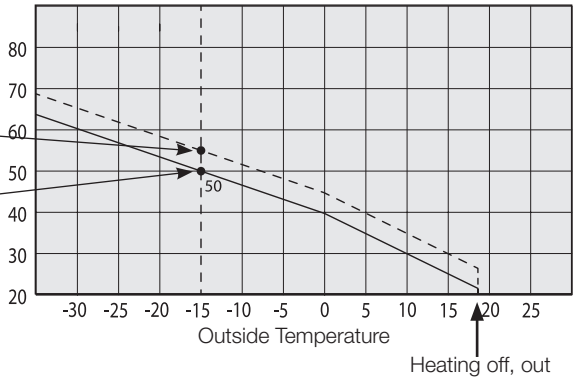

Primary Flow Temperature

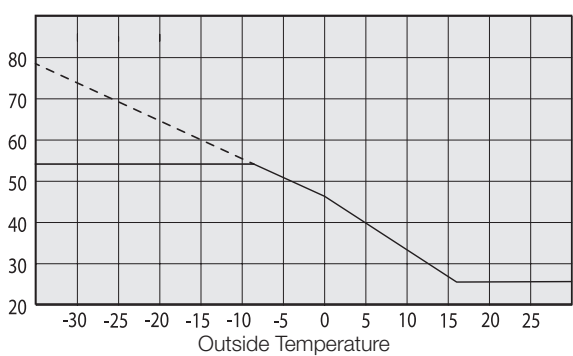

Summer-time operation

All properties have internal heat gains (lamps, oven, body heat, etc.), which means that the heating can be switched off when the outdoor temperature is lower than the desired room temperature. The better insulated the house is, the earlier the heating from the heat pump can be switched off.

The example shows the product set at the default value of 18°C. This value, "**Heating off, outside**", can be changed in the Advanced/Settings/Heat System menu. In systems with a radiator pump, the radiator pump stops when the heat is switched off. The heating starts up automatically when it is required again.

Automatic or remote-controlled summer period

The factory setting causes "summer" to commence automatically at 18°C, as "Heating mode" is set to "Auto".

Heating, mode **Auto (Auto/On/Off)**

Auto means automatic.

On means that the heating is on. For systems with a mixing valve and a radiator pump, the mixing valve operates to the primary flow setpoint and the radiator pump is on.

Off means that the heating is switched off. For systems with a radiator pump, the radiator pump is switched off.

Heating, ext. mode **- (- /Auto/On/Off)**

Facility for remote control of whether the heating is to be on or off.

Auto means automatic.

On means that the heating is on. For systems with a mixing valve and a radiator pump, the mixing valve operates to the primary flow setpoint and the radiator pump is on.

Off means that the heating is switched off. For systems with a radiator pump, the radiator pump is switched off.

- No selection means no function when activated.

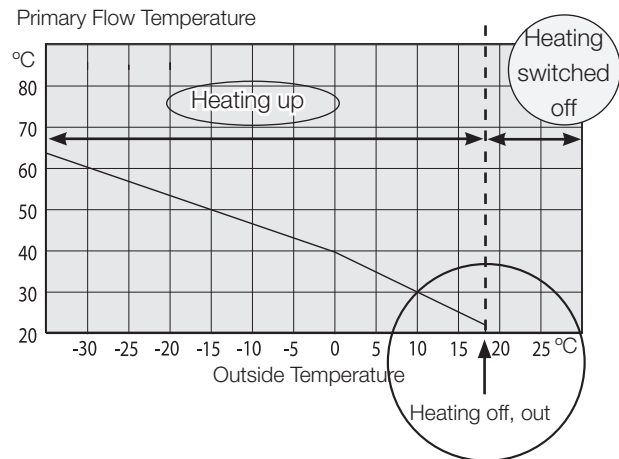

2. Technical data

2.1 Table 400V 3N~

Electrical Data		CTC EcoZenith i250 H	CTC EcoZenith i250 L
Electrical data		400 V 3N~ 50 Hz	
Rated power	kW	15.04	15.04
Immersion heater (steps of 0,3 kW)	kW	0 - 15.0	
Max immersion heater output @ fuse size 16 / 20 / 25 A	kW	3+6/6+6/9+6	
IP class		IP X1	

Heating system		CTC EcoZenith i250 H	CTC EcoZenith i250 L
Water volume. thermal store (V)	l	223	
Max. operating pressure. thermal store (PS)	bar	2,5	
Max. temperature. thermal store (TS)	°C	110	
Pressure drop for mixing valve heating		See pressure drop diagram in the Pipe installation chapter	

Hot water system		CTC EcoZenith i250 H	CTC EcoZenith i250 L
Water volume, hot water coil (V)	l	5,7	
Max. operating pressure, hot water coil (PS)	bar	10	
Max. temperature, hot water coil (TS)	°C	110	

Other data		CTC EcoZenith i250 H	CTC EcoZenith i250 L
Weight	kg	182	167
Depth x Width x Height	mm	672x595x1886	672x595x1652
Minimum ceiling height	mm	1901	1659

2.2 Table 230 V 1N~

Electrical Data		CTC EcoZenith i250 H	CTC EcoZenith i250 L
Electrical data		230V 1N~ 50 Hz	
Rated power	kW	12,04	12,04
Immersion heater (steps: 3, 5, 7, 9, 12 kW)	kW	0-12	
IP class		IPX1	

Heating system		CTC EcoZenith i250 H	CTC EcoZenith i250 L
Water volume. thermal store (V)	l	223	
Max. operating pressure. thermal store (PS)	bar	2,5	
Max. temperature. thermal store (TS)	°C	110	
Pressure drop for mixing valve heating		See pressure drop diagram in the Pipe installation chapter	

Hot water system		CTC EcoZenith i250 H	CTC EcoZenith i250 L
Water volume, hot water coil (V)	l	5,7	
Max. operating pressure, hot water coil (PS)	bar	10	
Max. temperature, hot water coil (TS)	°C	110	

Other data		CTC EcoZenith i250 H	CTC EcoZenith i250 L
Weight	kg	182	167
Depth x Width x Height	mm	672x595x1886	672x595x1652
Minimum ceiling height	mm	1901	1659

3. Measurements

Low version

High version

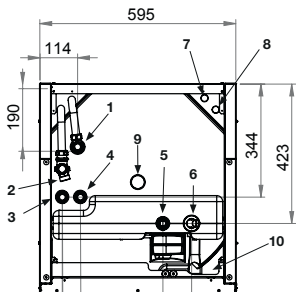
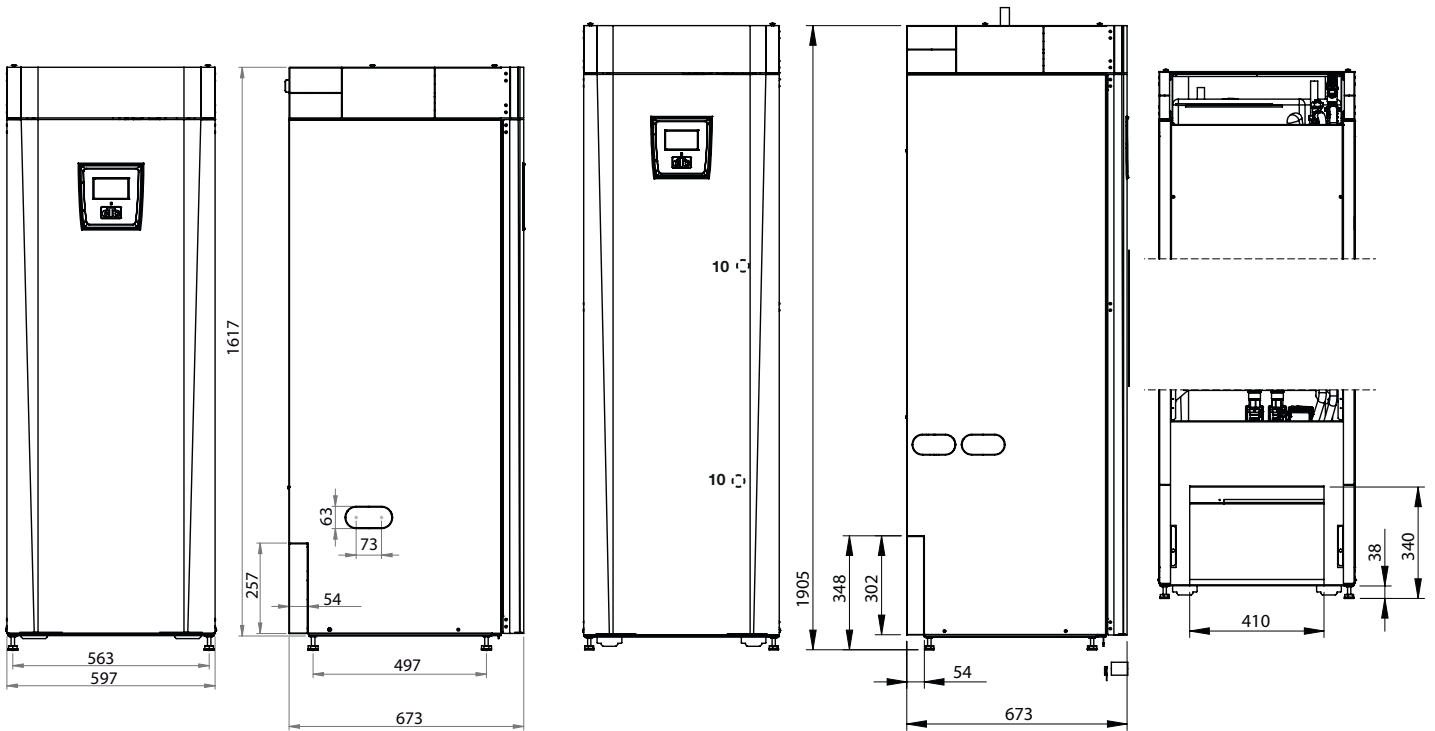

1. Bleeding
2. Safety/connection waste pipe 3/4" 22
3. Cold water connection Ø22
4. Hot water Ø22
5. Radiator primary flow 22 compression
6. Radiator return Ø22 mm/expansion connection
7. From heat pump Ø22 (CTC EcoZenith i250L)
8. To heat pump Ø22 (CTC EcoZenith i250L)
9. Lifting sleeve 3/4" BSP
10. Sockets for connection of external systems/Energyflex (behind front plate)

4. CTC EcoZenith i250 design

The picture below shows the basic construction of CTC EcoZenith i250.

If a heat pump is connected, the energy in the air or bedrock/ground is drawn up by the cooling system. The compressor then increases the temperature to a usable level. Afterwards it releases the energy for the heating system and hot water. The built-in immersion heaters help when additional heat is needed or when a heat pump is not connected.

Fresh Water Connections

Here you connect the property's fresh water connections. The cold water is fed down and heated in the lower part of the coiling.

Upper part

In the upper part of the coil the hot water is then heated to the desired temperature.

Finned Coil for Hot Water

The EcoZenith i250 is equipped with a well-dimensioned finned coil made of copper. Since hot water is not stored, there is no risk of legionella bacteria.

Upper immersion heater

Built-in upper immersion heater. When connected to a heat pump, the immersion heater acts as additional heat.

Lower immersion heater

Built-in lower immersion heater. Not used in normal operation when the heat pump is connected.

Draining/expansion vessel connection

Two connections in the lower part of the product where water from the boiler and radiator system can be drained and an expansion vessel connected.

Heat pump pipes

The CTC EcoZenith i250 L is equipped with connection pipes for top connection

Bivalent Mixing Valve

The automated mixing valve ensures that an even heat is continuously supplied to the radiator system.

Insulation

The heat pump's tank is insulated with die-cast polyurethane foam for minimal heat loss.

Lower part

In the lower part of the coil the hot water is pre-heated by the water heated by the heat pump. The major section of the coil is located in this part.

Expansion connection

15 mm.

Diverting valve

The heated water from the heat pump heats up the upper or lower part of the tank alternately.

Heat medium pump

The adjustable-speed charge pump transports the cold water from the boiler to the heat pump where the energy from the air or bedrock/ground is drawn up and taken back to the boiler.

The boiler is supplied with a circulation pump for a heat pump of up to 12 kW!

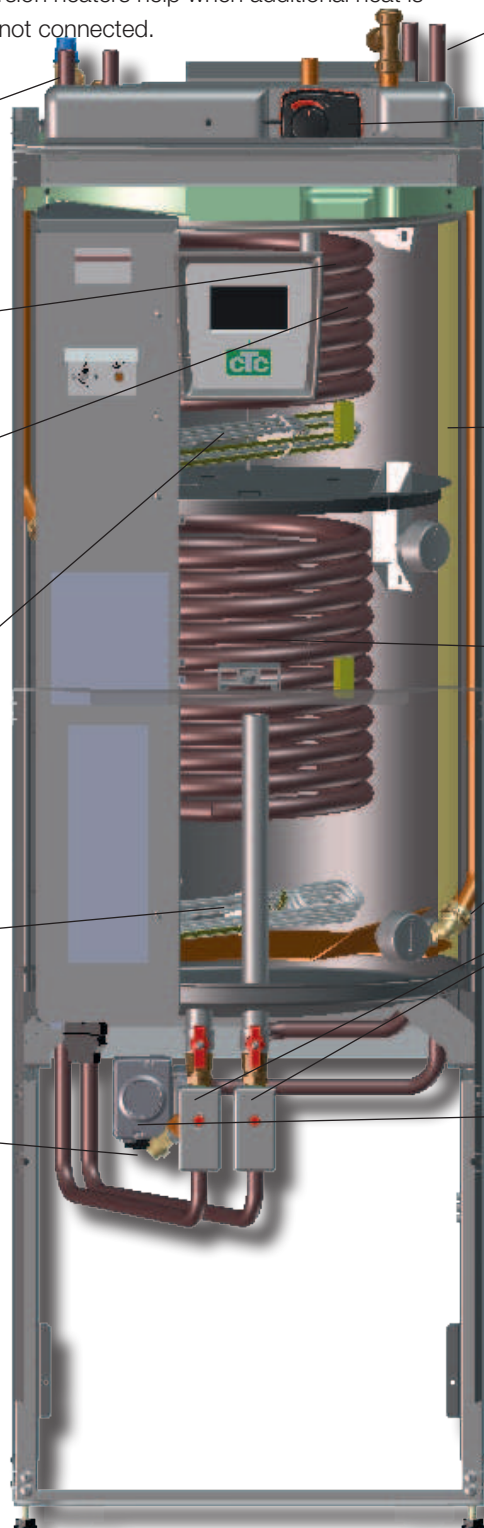



5. Parameter list

Radiator system	Factory value	User (set) value
Max. primary flow °C	55	
Min. primary flow °C	Off	
Heating, mode	Auto	
Heating mode, ext	-	
Heating off, out °C	18	
Heating off, time	120	
Inclination °C	50	
Adjustment °C	0	
Night reduction disable °C	5	
Room temp. reduced	-2	
Primary flow reduced	-3	
Alarm room temp °C	5	
Anti Water Hammer	No	
DHW increase	Yes	
CTC EcoPart heat pump	Factory setting	User (set) value
Compressor	Blocked	
Brine pump on	Auto	
Tariff HP	Off	
Minimum run time	6	
CTC EcoAir heat pump	Factory setting	User (set) value
Compressor	Blocked	
Stop at outdoor°C	-22	
Tariff HP	Off	
Minimum run time	6	
Immersion heaters	Factory value	User (set) value
Boiler upper °C	45	
Boiler upper add °C	57	
Boiler upper extra DHW °C	60	
Boiler upper max kW	5.5	
Boiler lower °C	55	
Boiler lower kW	6.0	
Delay mixing valve min	180	
Main fuse A	20	
Conv. factor curr. sensors	1	
Input voltage	3x400 V	
Tariff EL	Off	
Upper tank	Factory value	User (set) value
Stop temp. HP °C	Max.	
Start/stop diff. upper °C	7	
Max. time upper tank	20	
Max. time lower tank	40	

6. Control system

The CTC EcoZenith i250 has an advanced yet straightforward control system with a touchscreen on which all settings are entered directly.

The CTC EcoZenith i250 control system:

- monitors all functions in the system tank, heat pump and heating system.
- Permits individual settings
- Displays desired values, such as temperatures, operation times, energy consumption and fault signals.
- Facilitates the setting of values and troubleshooting in a simple and well-structured way.

Factory values

The CTC EcoZenith i250 is delivered with set factory values which are suitable for a standard house with a standard radiator system. The CTC EcoZenith i250 automatically adjusts the water temperature to the primary flow's current heating requirement. This is monitored by the control system, which continuously ensures that you are provided with optimum function and economy. These values are easy to change as and when required. Ask your installer to help you determine the correct values.

Heat pump

On delivery the CTC EcoZenith i250 is ready for connection to a CTC heat pump – either the CTC EcoAir 400 outdoor air heat pump, the CTC EcoAir 500M or the CTC EcoPart 400 bedrock/ground source heat pump.

NB: Note that the connection of the CTC EcoAir 500M inverter is dealt with in a separate section!

This means that the control system already contains all the controls for the heat pump. When the heat pump has been defined (On) the CTC EcoZenith i250 senses which heat pump has been connected

Installer/Define/Heat pump

Once this has taken place the menus for the heat pump are displayed. On delivery the compressor is blocked and must be set to permitted. This is done under the Installer/Settings/Heat pump menu.

CTC EcoVent

The product is ready for connection to ventilation unit CTC EcoVent.

Menu structure

The product's menus are described on the following pages. First there is an overview and then each menu is described in detail.

Start menu

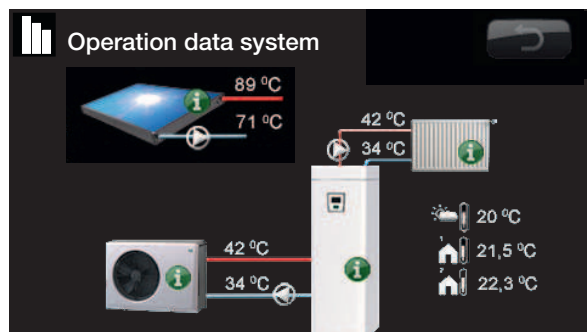
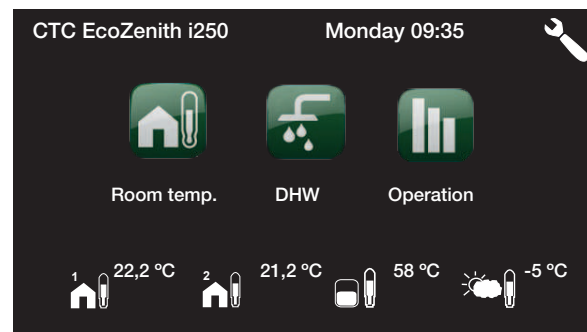

The screen shows operating information with the CTC EcoAir heat pump connected.



The screen shows operating information with the CTC EcoPart heat pump connected.

7. Menu overview

Start menu

CTC EcoZenith i250 Monday 09:35

Room temp. DHW Operation

1 22,2 °C 2 21,2 °C 58 °C -5 °C

Room temperature settings

Room temp.

Heating circuit 1 22,4 °C (23,5) °C

Heating circuit 2 (50)

1 Night reduction 2 Holiday

Selecting DHW comfort

DHW

Extra Hot water On 0.0 hours

Temperature Normal

Weekly schedule

Heating system data

Operation data system

89 °C

71 °C

42 °C

34 °C

42 °C

34 °C

20 °C

21,5 °C

22,3 °C

Installer settings menu

Installer

Time/Language Settings Define system Service

Software display PCB: 20120205
Software HP PCB: 01234

Room temperature settings

Room temp.

Heating circuit 1 22,4 °C **(23,5) °C** - +

Heating circuit 2 (50) - +

1 2 **Holiday**

Night reduction heat circ. 1

Weekly program	Day by day	NR
Monday	00 - 06	22 - 24
Tuesday	00 - 06	22 - 24
Wednesday	00 - 06	22 - 24
Thursday	00 - 06	22 - 24
Friday	00 - 06	23 - 24
Saturday	00 - 08	23 - 24
Sunday	00 - 08	22 - 24

Night reduction heat circ.

Weekly program	Block	NR
Decrease	Sunday	22:00
Increase	Friday	14:00
Decrease	-----	00:00
Increase	-----	00:00

Holiday

Holiday period **3 days** - +

Selecting DHW comfort

DHW

Extra Hot water **0.0 hours** - +

Temperature **Normal**

Weekly schedule

Weekly program DHW

Weekly program	Day by day	DHW
Monday	06 - 09	18 - 21
Tuesday	07 - 09	-- --
Wednesday	08 - 09	-- --
Thursday	08 - --	-- - 21
Friday	08 - --	-- - 21
Saturday	10 - 12	20 - 23
Sunday	10 - 12	20 - 23

Heating system data

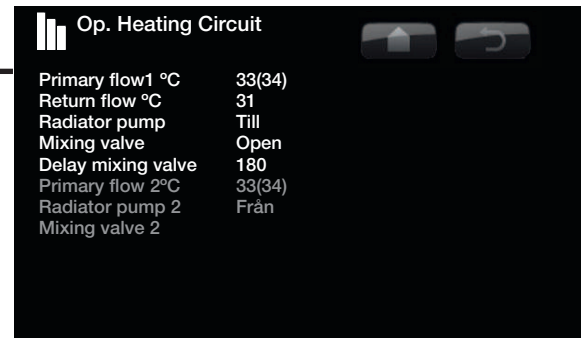
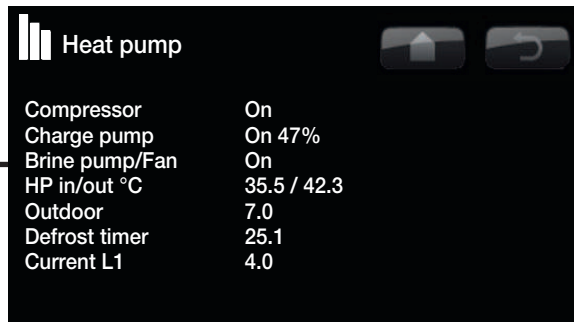
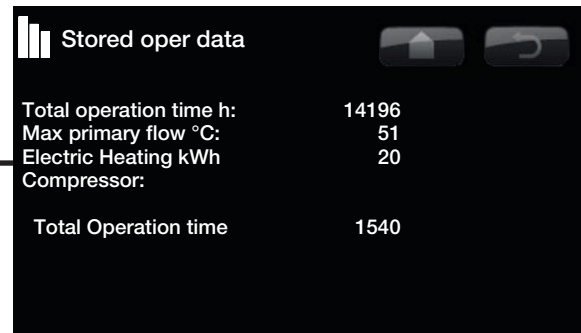
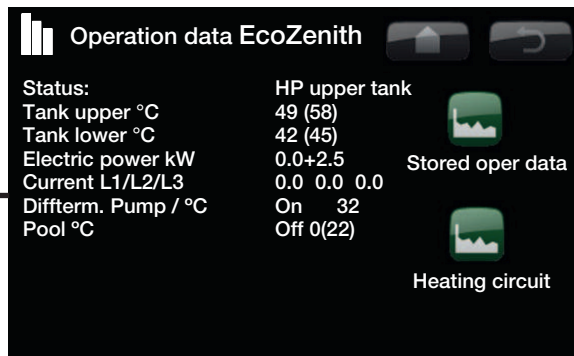
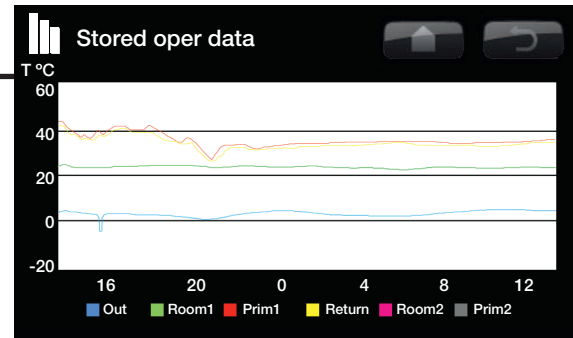
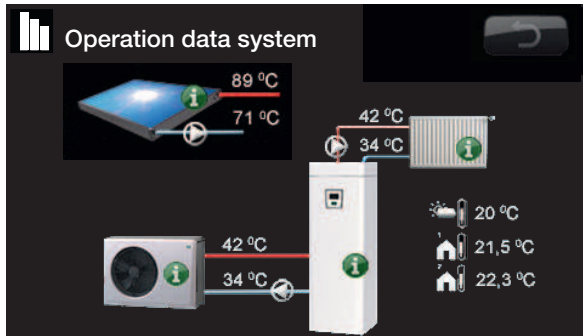

Installer settings menu

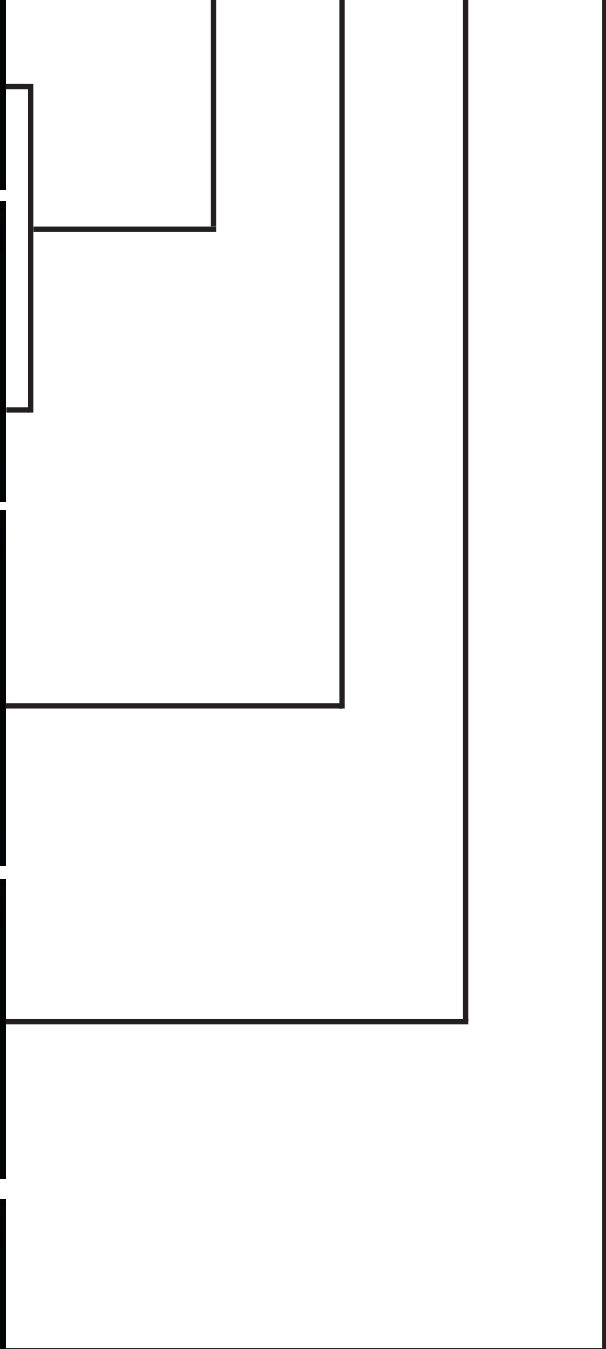
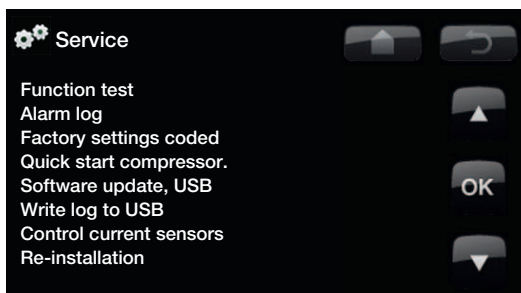
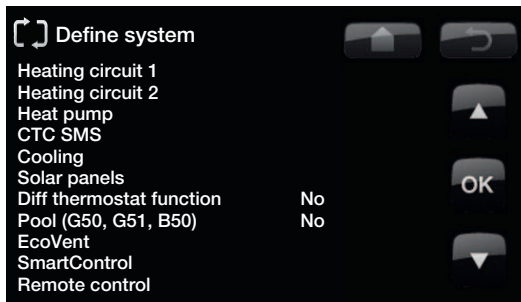
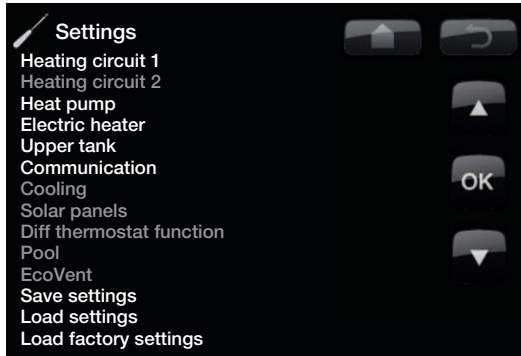
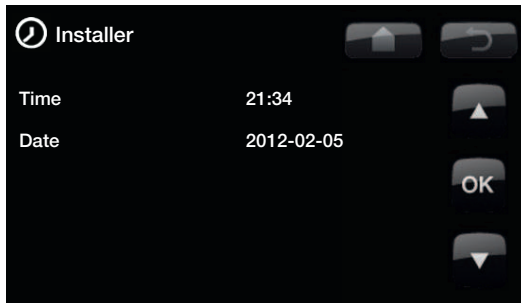

Settings menu

Settings

- Heating circuit 1
- Heating circuit 2
- Heat pump
- Electric heater
- Upper tank
- Communication
- Cooling
- Solar panels
- Diff thermostat function
- Pool
- EcoVent
- Save settings
- Load settings
- Load factory settings

Heating circuit 1

Max primary flow °C	55	
Min primary flow °C	Off	
Heating, mode	Auto	▲
Heating mode, ext		
Heating off, out °C	18	
Heating off, time	120	OK
Inclination °C	50	
>>	<<	
Adjustment °C	0	▼
Night disable °C	5	
Room temp reduced °C	-2 / -2	
Primary flow reduced °C	-3 / -3	
Alarm room temp °C	5	
Smart: Low price.	1	
Smart: Over capacity.	2	
>>	<<	
Anti Water Hammer	No	
HP max DHW	Yes	
Drying period mode	Off	
Drying period temp °C	25	

Set. heat pump

Compressor	Permitted	▲
¹ Stop at outdoor °C	-22	
² Brine pump on	Auto	
Tariff HP	Off	
Minimum run time	6	OK
Smart block HP	No	▼

Electric heater

Boiler upper °C	45	
Boiler upper add °C	57	
Boiler upper extra DHW °C	60	▲
Boiler upper max kW	5.5	
Boiler lower °C	55	
Boiler lower max kW	6.0	
Delay mixing valve min.	180	OK
Main fuse A	25	
Conv. factor curr. sensors	1	
Input voltage	3x400 V	
Tariff EL	Off	▼
Smart block immersion	Off	
Smart block mixing valve	Off	

Upper tank

Stop temp HP °C	Max	▲
Start/stop diff upper °C	7	
Max time upper tank	20	
Max time lower tank	40	
Smart: Low price. °C	10	
Smart: Over capacity. °C	10	OK
Time ExtraDHW Remote Contr.	0.0	▼

Sett. Diff thermostat function

Charge start diff temp °C	7	
Charge stop diff temp °C	3	▲
Charge temperature °C	60	
		OK
		▼

Menu to define the system

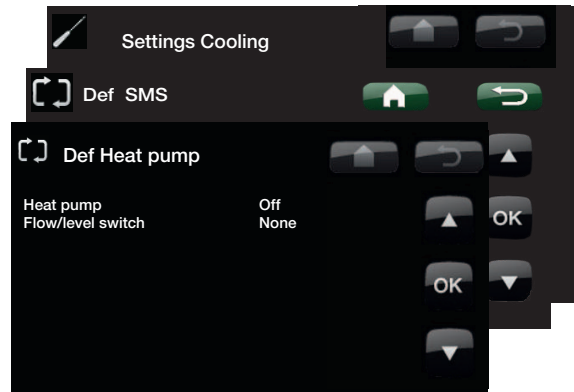
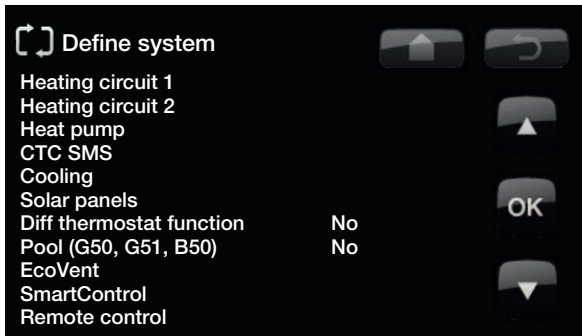

Service menu

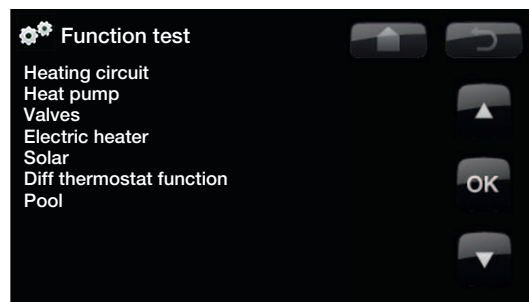
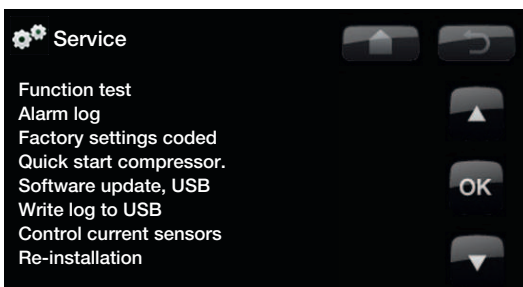

8. Detail Description Menus

All the settings can be configured directly on screen using the well-structured control panel. The large icons operate as buttons on the touch display.

Operational and temperature information is also displayed here. You can easily enter the different menus to find information on the operation or to set your own values.

8.1 Start menu

This menu is the system's start menu. This provides an overview of the current operation data.

The system returns to this menu if no buttons are pressed within 10 minutes. All other menus can be accessed from this menu. NB: Some menus are only shown if a heat pump is installed.

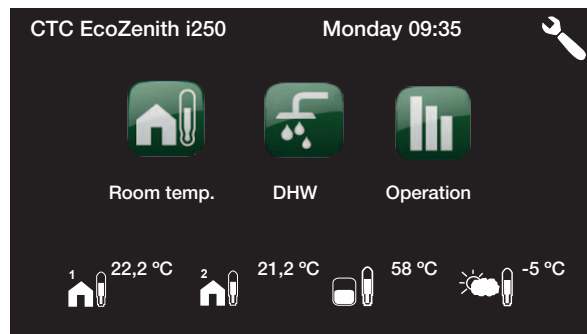

Room temp.

Settings for raising or lowering the temperature indoors and also for scheduling temperature changes.



DHW

Settings for DHW production.



Operation

This displays current operational data for both your heating system and heat pump. Historical operational data is also available.



Installer

This option is used by the installer to configure the settings and servicing for your heating system.



Room temp. Radiator system 1

If radiator system 1 is defined, the current room temperature is displayed here.



Room temp. Radiator system 2

If radiator system 2 is defined, the current room temperature is displayed here.



Tank temperature

This displays the current temperature in the upper part of the tank.



Outdoor temperature

This displays the current outdoor temperature.



Home

The Home button takes you back to the Start menu.



Return

The Return button takes you back to the previous level.



OK

The OK button is used to mark and confirm text and options in the menus.



Night reduction

This schedules a temperature reduction at night if selected.



Holiday

You can use this to reduce the room temperature permanently, e.g. during holidays when the house is unoccupied.



Weekly program

This is used to reduce the temperature for a few days, for instance if you commute every week.



Stored operation data

This displays historical data.



Time/Language

This is used to set the date, time and the language you want the menu to be displayed in.



Settings

The settings for operation of EcoZenith and the system are usually configured by the installer.



Define system

The heating system's structure can be adjusted/modified using this option.



Service

Advanced settings are configured by the appropriate technical person.

8.3 Room temp.



This is used to set the desired room temperature. Use the plus and minus buttons to set the temperature you want, which gives you the “setpoint” temperature, shown in brackets. You can see the current value next to the brackets.

If two radiator systems are installed, the values for both are displayed.

If you want to schedule a temperature reduction, you can continue to the Night reduction or Holiday submenus.

You can select Room sensor No under the Installer/Define system/Radiator system menu. This can be done if the room sensor is awkwardly positioned, if the floor heating control has its own room sensors or if you use a fire place or open stove. The alarm LED on the room sensor still functions as normal.

If you use the fire or open stove only occasionally, the firing process can affect the room sensor and reduce the temperature supplied to the radiators. It can then get cold in the rooms in other parts of the house. The room sensor can temporarily be deselected during the firing process. The CTC EcoZenith i250 then provides heating to the radiators using the set heating curve. The radiator thermostats reduce the heating supplied to the section of the house where a fire is burning.

8.3.1 Setting a room temp. without a room sensor

If a room sensor has not been installed (this can be selected from the Installer/Define/Radiator system menu), the room temperature is adjusted using this option, which displays the setting range as a percentage. (50) denotes default setting; the heat can be increased or decreased in variable adjustments from this value. If this range is not sufficient, the basic setting must be adjusted under the Installer/Settings/Radiator system menu.

Change the value in small steps each time (approx. 2 to 3 steps) and wait for the result (approx. one day), as there is a delay in the system responding.

Several adjustments may be necessary at different outdoor temperatures, but you will gradually achieve the right setting that will not need to be changed.



The example above shows that the room temperature is 22.4 °C and the desired value (setpoint) is 23.5 °C.

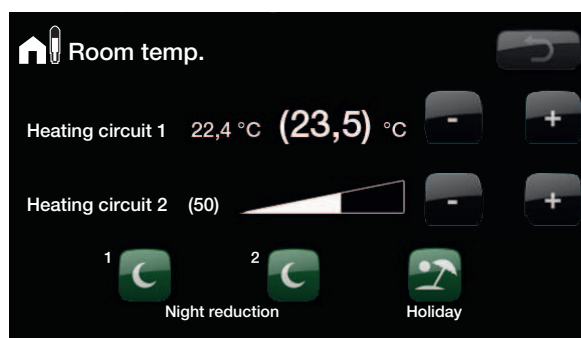

The example above shows how it operates with two radiator systems. Radiator system 1 with a room sensor and radiator system 2 without one.

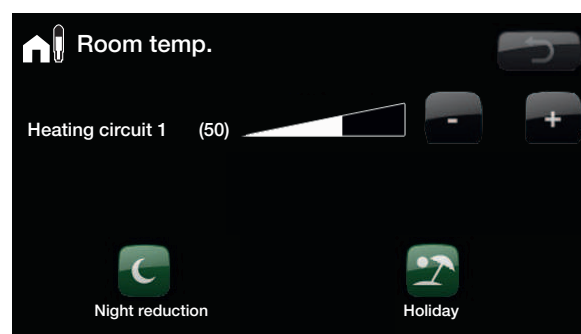

The example above shows how it operates with a radiator system. Radiator system 1 without a room sensor.

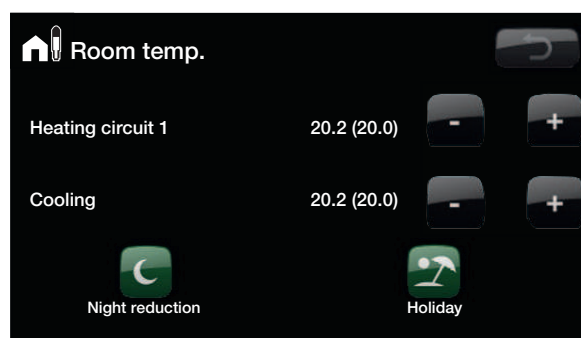

The example above shows how it operates with a radiator system and cooling.

8.3.2 Outdoor Sensor/Room Sensor Faults

If a fault occurs with an outdoor sensor, the product triggers an alarm and an outdoor temperature of -5 °C is simulated so that the house does not get cold.

If a fault occurs with a room sensor, the product triggers an alarm and automatically switches to operating according to the set curve.

The thermostats of the radiators must be fully open and well operating when the system is tuned.

8.3.3 Night reduction temperature



You use this menu to activate and set a reduction in the temperature at night. A night reduction means that you reduce the temperature indoors during scheduled periods, for example at night.

The value by which the temperature is reduced, **-Room temp. red./Prim. flow red.**, is set under Installer/Settings/Radiator system/
Factory setting: -2/-5 °C.

The options in the night reduction menu are: *Off*, *Day by Day* or *Block*. If you select *Off*, no reduction is made at all.

Day by day menu

You use this menu to schedule a reduction on the days of the week. This schedule is repeated every week.

Block

This menu allows you to set a reduction for a few days during the week, for example, if you are working elsewhere on weekdays and at home at weekends.

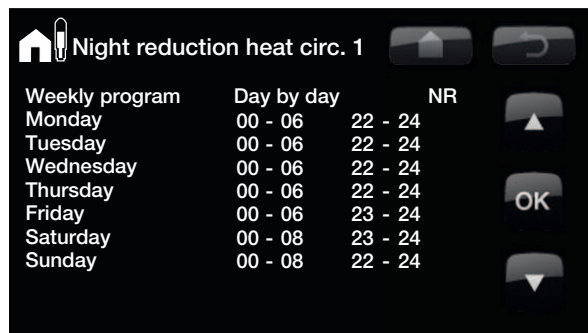

e.g. to activate night reduction of the temperature Mondays 00:00–06:00 and 22:00–24:00 etc.

When the clock is within the range, e.g. on a Monday at 03:00, "NR" is displayed

The time on the left must be lower than the time on the right for the interval to be valid.

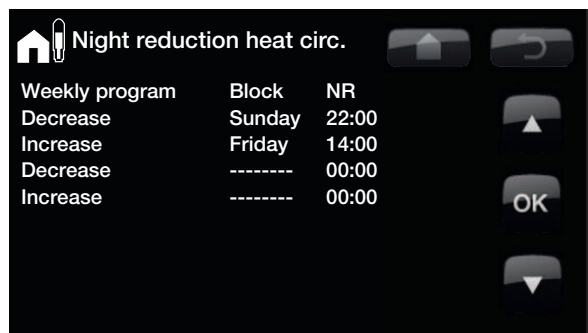

On Sunday at 10 pm, the temperature is lowered by the set value in the *Room temp. reduced* menu (in the *Installer/Settings* menu). On Friday at 2 pm the temperature is increased to the set value again.

When both are in use, Holiday Reduction overrides Night Reduction.

8.3.4 Holiday



You use this option to set the number of days for which you want the set night reduction temperature to be constantly reduced. For example, if you want to go on holiday.

You can apply this setting for up to 300 days.

The period starts from the time you set this parameter for.

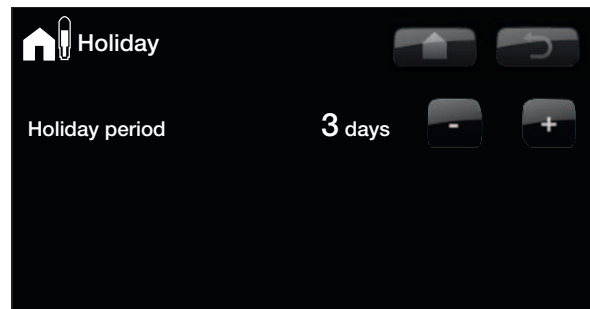

When holiday is enabled, hot water production is stopped. Temporary extra hot water and the weekly program for extra hot water are stopped. The heat pump only operates in the lower tank.

i The value by which the temperature is reduced, -Room temp./Prim. flow red., is set under Installer/Settings/Radiator system/Factory setting: -2/-3 °C.

8.4 DHW



You use this to set the DHW comfort level you want and extra DHW.

Temperature

You set the values for this option which apply to the CTC EcoZenith i250's normal operation. There are three modes:



Economic – Small hot water requirement.



(Temperature Tank lower ≥ 35 °C)
Normal – Normal DHW requirement.



(Temperature Tank lower ≥ 40 °C)
Comfort – Large DHW requirement.

(Temperature Tank lower ≥ 45 °C)

Extra hot water

Select this option if you want to activate the Extra DHW function. When the function is activated (by setting the number of hours) the heat pump immediately starts to produce extra DHW. You also have the option to schedule hot water production for certain times using the Weekly program function (recommended).

Setpoint Upper tank 60°C (Electric boiler extra DHW °)

Setpoint Lower tank = 58°C

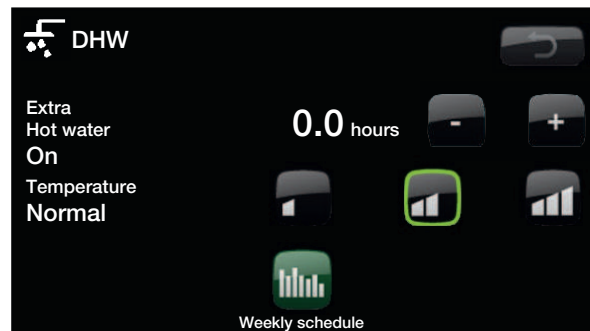

i Tip: Start by setting to Economic and if you find that you are not getting enough hot water, increase it to Normal, and so on.

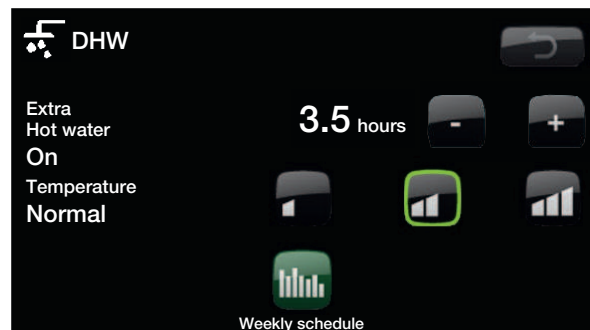

The example above shows that Temporary extra DHW is activated (On) for 3.5 hours.

8.4.1 Weekly program DHW



You can use this menu to schedule periods during weekdays when you want extra hot water. This schedule is repeated every week.

Options for the weekly program are *Off* or *Day by day*.

Off

No scheduled hot water production.

Day by day

A weekly schedule which you program yourself. This is used if you always know when you repeatedly need extra hot water, for instance in the morning and evening.

Example 1:

Monday 06-09 18-21

On Monday the timer comes on from 06–09 and 18–21; normal operation applies apart from these times.

Example 2:

Thursday 06 - - - - - 21

The timer comes on from 06–21 on Thursdays.

Weekly program	Day by day	DHW
Monday	06 - 09	18 - 21
Tuesday	07 - 09	-- - --
Wednesday	08 - 09	-- - --
Thursday	08 - --	-- - 21
Friday	08 - --	-- - 21
Saturday	10 - 12	20 - 23
Sunday	10 - 12	20 - 23

On Monday morning at 6 am the system starts producing more hot water until 9 am when the temperature returns to normal again. There is a further increase between 6 pm and 9 pm. When the clock is within the range, e.g. on a Monday at 03:00, "DHW" is displayed

Tip: Set the time approx. 1 hour earlier than you need the hot water as it takes some time to heat up the water.

8.5 Operation data system



This menu displays current temperatures and the operational data for your heating system.

Primary flow radiators

The temperature of the primary flow to the house's radiators is shown above the CTC EcoZenith i250 (42°C). This value will vary during the year according to the parameters set and the current outdoor temperature.

Return radiators

The return temperature of the radiator water returning to EcoZenith is also shown above the CTC EcoZenith i250 (34°C). This value will vary during operation according to the parameters set, the radiator system's capacity and the current outdoor temperature.

The screens also show the incoming and outgoing temperatures from the heat pump installed.

HP out

At the right of the heat pump (42°C) the heat pump's outgoing temperature is shown.

HP in

At the right of the heat pump (34°C) the heat pump's return temperature is shown.

Brine in (CTC EcoPart only)

At the top left of the EcoPart (2°C) the brine's current temperature from the collector to CTC EcoPart is shown.

Brine return (CTC EcoPart only)

The bottom left value (-1 °C) is the return temperature of the brine going back into the collector hose. The values vary during the year according to the heat source's capacity and the energy drawn out.

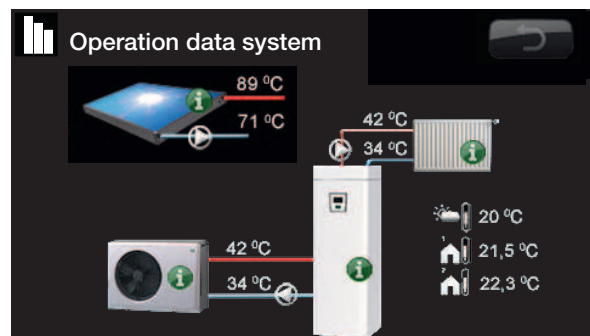

The screen shows operational data with the CTC EcoAir connected. When the pumps are in operation, the pump icons also rotate on screen.



The screen shows operating information with the CTC EcoPart connected. When the pumps are in operation, the pump icons also rotate on screen.



Information

Press the information button to display the operational data for the relevant item.



Current outdoor temperature

Shows the current outdoor temperature. The product uses this value to calculate the various operational parameters.



Current indoor temperature

Shows the current room temperature (if a room sensor is selected during operation). If two radiator systems are installed, the values for both are displayed.

8.5.1 Operation data EcoZenith



This menu displays current temperatures and the operational data for your EcoZenith i250. The first figure is the actual operational value, with the value in brackets being the setpoint which EcoZenith is trying to achieve.

Status

Shows EcoZenith i250's operational status.

The various operational status options are:

- **HP upper tank**
The heat pump heats up the upper part of the tank (DHW production).
- **HP lower tank**
The heat pump heats up the lower part of the tank. (Heat production).
- **HP + Add**
Both the immersion heater and heat pump are operating to heat up the tank.
- **Add**
Only the immersion heater is heating the tank.

Tank upper °C **49 (60)**

Shows the temperature and reference value in the upper part of the tank.

Tank lower °C **42 (50)**

Shows the temperature and reference value in the lower part of the tank.

Electric power kW

Shows the electric boiler's additional power. Lower and upper electric heaters. Example of 0.0 kW in lower electric heater and 2.5 kW in upper electric heater.

Current L1/L2/L3

Shows the system's total current consumption at the various phases L1/L2/L3, provided that three current sensors have been fitted to the unit's incoming cables. If the current sensors mounting devices are not identified, only the phase with the highest load is displayed.

If the current exceeds the main fuse size, the boiler automatically switches down a power step to protect the fuses, for example, when several high-consumption appliances are being used in the house.

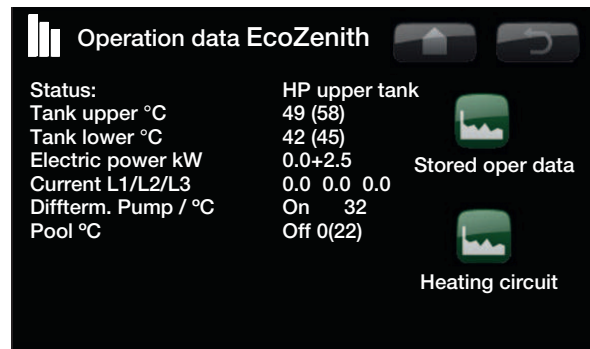

Three Current values are displayed when the current transformers (CTs) are connected and identified. If only one figure is displayed:

- connect all three current transformers (CTs).
- then select the option Installer/Service/Control current sensors.

The first figure is the current operating value. The value in brackets is the setpoint that the CTC EcoZenith is trying to achieve.

Diff func. Pump / °C**Off / 30**

Differential thermostat function

Shows whether charge pump (G46) is switched on (ON, OFF). Displays temperature of external tank. °C (B46)

Pool °C**Off 23 (22)**

Pool function

Shows whether pumps (G50,G51) are switched on (ON, OFF). Displays pool temperature and (setpoint)

If the expansion card (A3) has not been installed and Pool has been defined, the product will emit an alarm:

Comm. fault expansion card.

8.5.2 Operation Heating circuit

Primary flow 1 °C

Shows the temperature supplied to the system's radiators, along with the temperature which the system is trying to achieve. This value will vary during the year according to the parameters set and the current outdoor temperature.

Return flow °C

Shows the temperature of the water returning from the radiator system to the CTC EcoZenith i250.

Radiator pump

Shows the radiator pump's operational status.

Mixing valve

Shows whether the mixing valve increases (opens) or reduces (closes) the heat supplied to the radiators. When the correct temperature has been achieved with the mixing valve, the valve's motor then remains stationary.

Delay mixing valve

A microswitch in the mixing valve's motor ensures that auxiliary heating is not used unnecessarily, for example, when ventilating a room or if the temperature (outdoors) occasionally drops during the night. The mixing valve is delayed for the time period selected before auxiliary heating is used. The screen shows the countdown of the delay in minutes. If "Blocked" is shown, never open the mixing valve to the immersion heaters of the upper tank.

Primary flow 2 °C etc...

Displayed if radiator system 2 or Cooling has been defined

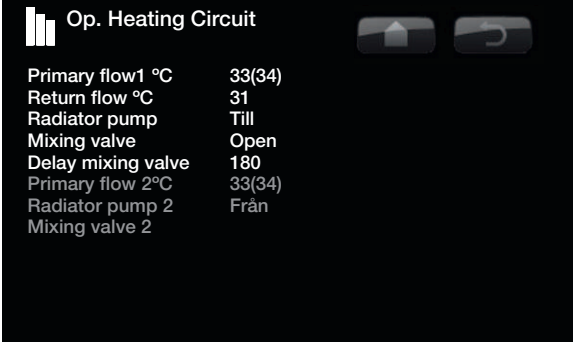

Op. Heating Circuit	
Primary flow1 °C	33(34)
Return flow °C	31
Radiator pump	Till
Mixing valve	Open
Delay mixing valve	180
Primary flow 2°C	33(34)
Radiator pump 2	Från
Mixing valve 2	

8.5.3 Stored operation data



This menu shows the operating values for the CTC EcoZenith i250 over a long period.

Total Operating Time h

Shows the total time during which the product has been on.

Maximum Primary Flow °C

Shows the highest temperature supplied to the radiators. The value may indicate the radiator system's/house's temperature requirements. The lower the value during the winter period, the more suitable it is for heat pump operation.

Electric Heating kWh

Shows the total energy consumed by the product's electric heaters. This is an indirect energy measurement, based on the operating periods of the immersion heaters.

Total operation time

Displays the total operating time of the compressor. (h)

Stored oper data	
Total operation time h:	14196
Max primary flow °C:	51
Electric Heating kWh	20
Compressor:	
Total Operation time	1540

8.5.4 Heat pump



EcoPart



EcoAir

Compressor On (On/Off)

Shows whether the compressor is operating or not.

Charge pump On 47%

Shows the charge pump's operational status and flow as a percentage. (The example shows that the charge pump is currently operating at 47% speed.)

Brine pump/Fan On (On/Off)

Shows whether the brine pump/fan is operating or not.

HP in/out °C 35.5/42.3

Shows the heat pump's return and primary flow temperatures.

(The example shows a return temperature of 35.5°C and a primary flow temperature of 42.3°C.)

Outside temp °C 3.0 (-50 to 50)

Shows the outside temperature (sensor B15). Shown for EcoAir heat pumps.

Defrost timer 30

Shows the time remaining until the CTC EcoAir goes into defrosting mode. In order for defrosting to start, the temperature in the heat pump's evaporator must be low enough.

Current L1

Shows the current across the compressor (phase L1).

Heat pump	
Compressor	On
Charge pump	On 47%
Brine pump/Fan	On
HP in/out °C	35.5 / 42.3
Outdoor	7.0
Defrost timer	25.1
Current L1	4.0

8.5.5 Operation data heating



This displays the heating system's operation data for the last 24 hours. The furthest point to the right is the present, while the data for the last 24 hours is displayed to the left. The time "rolls" forward.

The blue curve is the current outdoor temperature.

The green and pink curves are room temperatures 1 and 2, respectively.

The red and grey curves are primary flow temperatures 1 and 2, respectively.

The yellow curve is the CTC EcoZenith i250 return temperature.

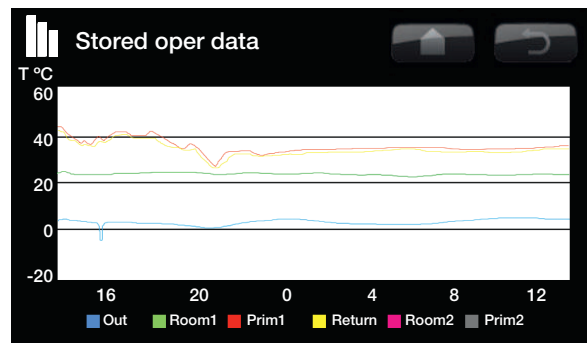

8.6 Installer



This menu contains four sub-menus. Time/Language, Settings, Define system and Service.

Time/Language includes time and language settings for your CTC EcoZenith i250.

Settings are used both by the installer and users for installing the system.

Define system is used by the installer to define the contents of your heating system.

Service is used for troubleshooting and diagnosis. You will find here the options Function test, Alarm history, Factory settings code, Quick start compressor and Software update.

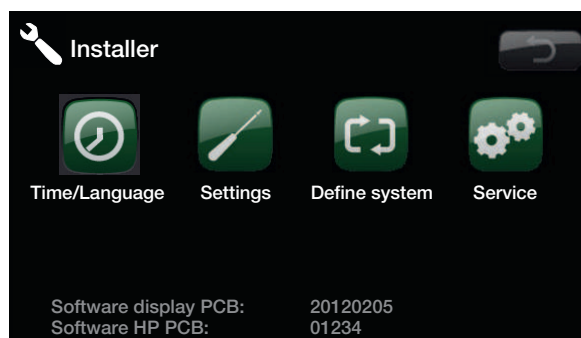

8.6.1 Time/Language



You use this to set the date and time. The clock has a power backup and continues to run in the event of a power cut. Summer/winter time is changed automatically.

Time settings

When a green box appears around the time, press OK and the first value is selected. Use the arrows to set the correct value.

When you press OK, the next value is highlighted.

Setting the language

The current language has a green circle around it.

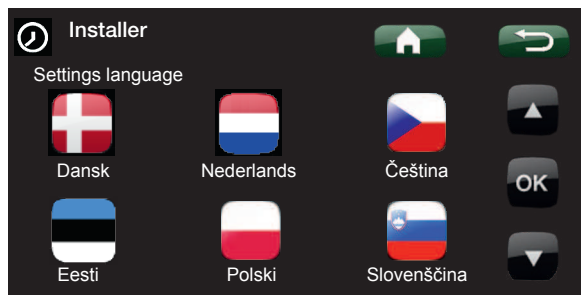
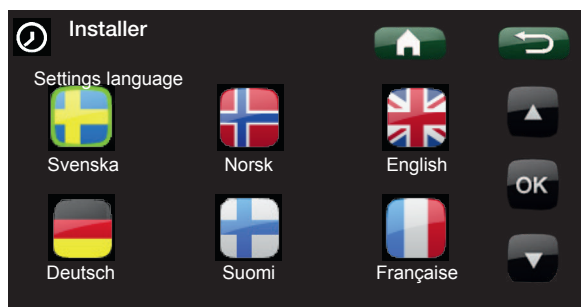
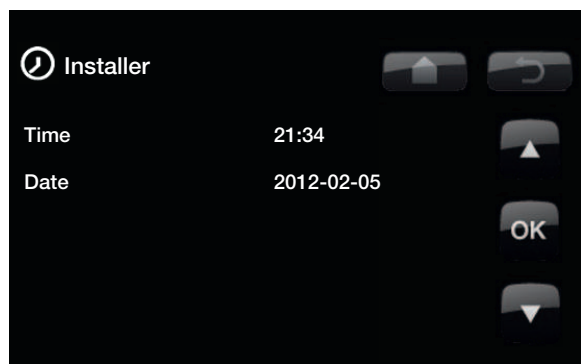

8.7 Settings



This is used to set the parameters for operating the system. It is important that this default setting is adjusted for your property. Values which are set incorrectly may mean that your property is not warm enough or that an unnecessarily large amount of energy is being used to heat your property.

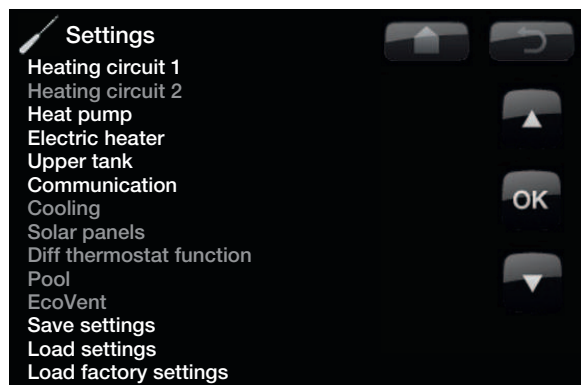

8.7.1 Heating circuit 1 or 2

Max. primary flow **55(30 – 80)**

The maximum permitted temperature supplied to the radiators. This functions as an electronic limiter to protect the floor coils in underfloor heating systems.

Radiator system 2 can only reach the same temperature as radiator system 1 or a lower temperature.

Min. primary flow **Off (Off, 15 – 65)**

You can use this option to set the minimum permitted temperature if you want a specific level of background heating during the summer in the basement or underfloor heating coils, e.g. in the bathroom. The heating in other parts of your property should then be switched off using thermostatic radiator valves or shut-off valves. Note that the radiator pump will then operate for the whole summer. This means that the temperature out to the radiators does not fall below a selected temperature, for example +27°C.

“Off” means that the function is turned off.

Heating mode **Auto/On/Off**

Switching of heating season or summer season can take place automatically (auto) or a selection can be made here to set the heating to be on or off.

Auto = the switch between heating season (On) and (Off) (also known as summer mode) takes place automatically.

On = Continuous heating season, the radiator pump circulates constantly.

Off = There is no heating, the radiator pump does not run (is turned over).

Heating mode, ext

Switching between heating and summer mode can be controlled remotely. Specify here what is to happen with remote control.

Find out more in the section entitled “Define/Remote control”.

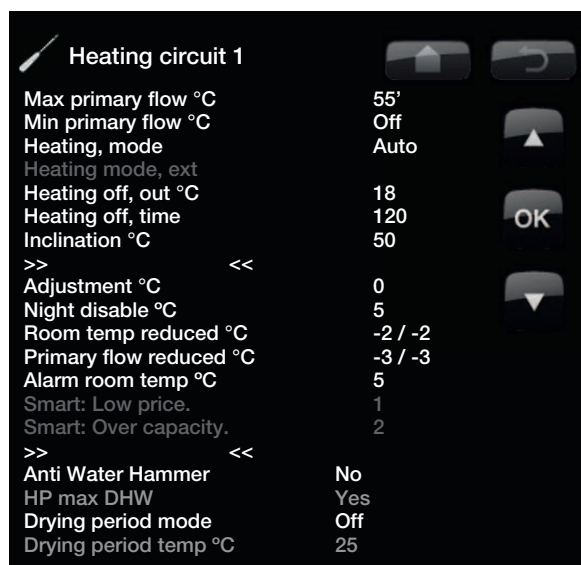

Tip: Read more about these settings in the chapter on Your property's heating installation.

For example:

“Inclination 50” means that the temperature of the water supplied to the radiators will be 50°C when the outdoor temperature is -15°C, if the adjustment is set to 0. If the adjustment is set to +5, the temperature will be 55°C instead. The curve is increased by 5°C at all outdoor temperatures, i.e. the curve is parallel offset by 5°C.

Heating off, outside **18(2 – 30)**

Outdoor temperature limit at which the house no longer requires heating. The radiator pump stops and the mixing valve is kept closed. The radiator pump is activated daily for a short period to reduce the risk of jamming. The system restarts automatically when heating is required.

Heating off, time **120(30 – 240)**

The delay period before the radiator pump stops as described above.

Inclination **50(25 – 85)**

Inclination means the temperature your property needs at different outdoor temperatures. See more detailed information about this in the chapter on Your property's heating installation. The value set corresponds to the temperature of the radiators when the outdoor temperature is -15°C. After this default setting, fine adjustment takes place in the "Room temperature" menu.

Adjustment **0 (-20 – 20)**

The curve adjustment means that the temperature level can generally be raised or lowered at all outdoor temperatures. After this default setting, fine adjustment takes place in the "Room temperature" menu.

Night disable °C **5 (-40 – 40)**

When the outdoor temperature is lower than this, the night reduction stops as too much energy is consumed and it takes a long time to increase the temperature. This menu overrides remote control.

Room temp. reduced °C **-2 (0 – -40)**

"Room temp. reduced" is displayed if a room sensor is installed.

You define here how many degrees the room temperature will be reduced by during the various scheduled reduction periods, e.g. Night reduction, Holiday, etc.

Primary flow reduced °C **-3 (0 – -40)**

If there is no room sensor installed, "Prim reduced" is displayed instead.

Alarm room temp °C **5**

When the room temperature is too low, the message "[E123] Alarm Low room 1 temp" is sent to CTC SMS. The room sensor must be connected and activated.

 Tip: Read more about these settings in the chapter on Your property's heating installation.

For example:

"Inclination 50" means that the temperature of the water supplied to the radiators will be 50°C when the outdoor temperature is -15°C, if the adjustment is set to 0. If the adjustment is set to +5, the temperature will be 55°C instead. The curve is increased by 5°C at all outdoor temperatures, i.e. the curve is parallel offset by 5°C.

Example:

Room temp red -2 means that the room temperature is reduced by 2 °C from its normal temperature.

Example:

As a general rule, a Prim reduced value of 3-4 °C is equivalent to a 1 °C reduction in room temperature in a normal system.

Smart low price °C **1 (Off, 1 – 5)**

Setting to increase curve adjustment at energy price low price, via Smart Grid.

Find out more in section entitled Define/Remote control/ Smart Grid

Smart Over capacity °C **2 (Off, 1 – 5)**

Setting to increase curve adjustment at energy price high capacity, via Smart Grid.

Find out more in section entitled Define/Remote control/ Smart Grid

Anti Water Hammer **No (No/Yes)**

Anti Water Hammer means that the heat pump never switches over and heats the upper tank (hot water charging). This is provided solely by the electric heater.

In summer mode however, i.e. if the outdoor temperature is above the limit (Heating off, outside), the heat pump will be allowed to send water to the upper tank.

HP max DHW **Yes (Yes/No)**

When Anti Water Hammer has been selected the “DHW increase” function opens.

Yes means that the heat pump will follow the temperature of the radiators for three start-ups. When the heat pump performs start-up no. 4 the heat pump works until it achieves “maximum heat pump temperature”. This is also termed “full condensation”.

No means that the heat pump will always follow the temperature of the radiators.

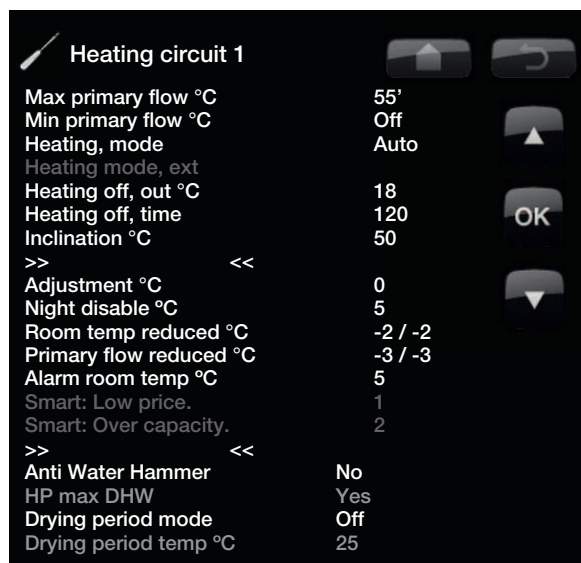

Drying period mode

Off (Off/1/2/3)

Floor drying function for newly-built properties.

The function limits the calculation of primary flow temperature (setpoint) for "Your home's heating installation" to the schedule below.

Mode 1

Floor drying function for 8 days.

1. The (setpoint) of the radiator system is set to 25°C for 4 days.
2. On Days 5–8, the value set in "Floor function temp. °C" is used.

(From Day 9 onwards the value is calculated automatically according to "Your home's heating installation")

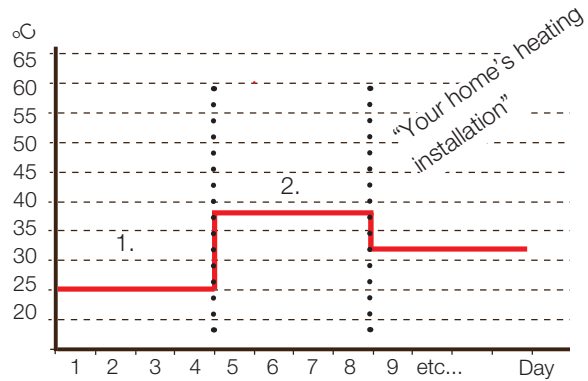

Example for Mode 1 with "Floor function temp. 38°C".

Mode 2

Floor drying function for 10 days + stepped increase and decrease.

1. Stepped increase start: The (setpoint) of the radiator system is set to 25°C. The (setpoint) is then raised by 5°C each day until its (setpoint) is equal to the "Floor function temp. °C".

The final step may be less than 5°C.

3. Stepped decrease: After the stepped increase and 10 days at an even temperature, the temperature (setpoint) is reduced to 25°C in daily 5°C stages.

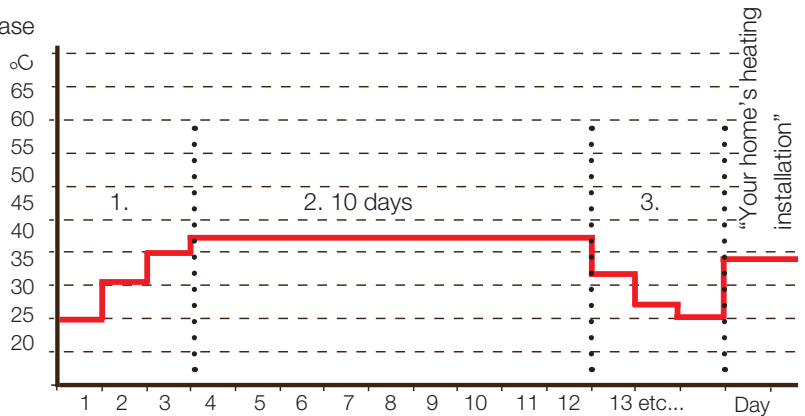

Example for Mode 2 with "Floor function temp. 37°C".

The final step may be less than 5°C.

(Following the stepped decrease and one day at the (setpoint) of 25°C the value is calculated automatically according to "Your home's heating installation".)

Mode 3

In this mode, the function starts in Mode 1 and this is then followed by Mode 2 and finally by "Your home's heating installation".

Floor function temp. °C 25 (25 – 55)

Here you set the temperature for Mode 1/2/3 as shown above.

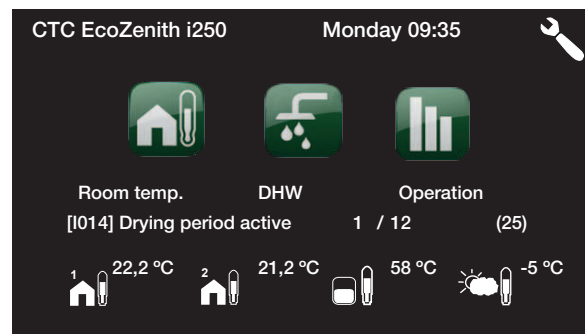

Example for operation data Mode 2, Day 1 of 12 with current (setpoint) 25°C.

8.7.2 Set. heat pump

Compressor **Permitted/Blocked**

The product is supplied with a blocked compressor. When the compressor is blocked, the product operates like an electric boiler. All other functions are intact.

Permitted means that the compressor is allowed to operate.

¹Stop at outdoor °C **-22 (-22 – 0)**

(Applies to the CTC EcoAir only)

This menu relates to settings for the outdoor temperature at which the compressor is no longer permitted to operate. When the heat pump has stopped a start signal will only be given if the outdoor temperature is at least 2 °C warmer than the set value.

²Brine pump **Auto/10d/On**

(Applies to the CTC EcoPart only)

- *10D*. After installation is complete, you can choose to run the brine pump constantly for 10 days to remove air from the system. The pump then returns to auto mode.
- *On* means that the brine pump will operate continuously.
- *Auto* means that the circulation pump (G20) will operate at the same time as the compressor.

Tariff HP **No (No/Yes)**

Find out more in section entitled "Define/Remote control".

Min oper. time **6 (0 – 20)**

Minimum operating time in minutes that the compressor is permitted to operate. Even if the tank's stop temperature has been achieved, the compressor continues to supply energy during this period.

Smart block HP **No (No/Yes)**

This is used when a dual tariff is used with lower energy costs at set hours of the day. Find out more in section entitled Define/Remote control/Smart Grid

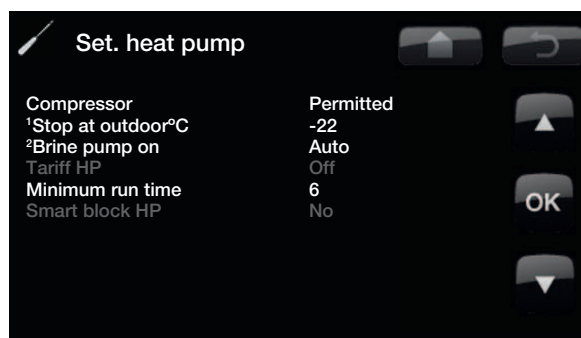

¹Applies to the CTC EcoAir

²Applies to the CTC EcoPart

8.7.3 Electric heater

Upper boiler °C **50 (30 – 60)**

Temperature when the immersion heater kicks in and helps CTC EcoZenith i250 to produce domestic hot water when there is great demand. A low setting is recommended.

The immersion heater is also responsible for providing the house with additional heating. If the house requires a higher temperature than that selected, the control system compensates by automatically raising the temperature of the immersion heaters.

This temperature also reflects the settings chosen under DHW.

Upper boiler add heat °C **57 (30 – 70)**

The temperature of the boiler when CTC EcoZenith i250 calls for assistance to reach the high temperature; the immersion heater then works up to this value after the set time delay on the mixing valve.

Upper boiler extra DHW **60 (30 – 70)**

This means the boiler is to provide extra DHW. This setting determines whether the electric heater should help to produce extra hot water. Set the temperature of the electric unit to the desired value when the option for extra hot water is activated under the DHW menu. A lower value means that the heat pump produces the majority of hot water, not the immersion heater.

Upper boiler max. kW **5.5 (0 – 9.0)**

You set the max. permitted power for the immersion heater here.

Setting for the maximum permitted power for the electric unit. 0 to 9.0 kW in steps of 0.3 kW.

Lower boiler °C **55 (30 – 70)**

Setting for the temperature of the lower immersion heater.

Lower boiler kW **6 (0/6.0)**

Setting for the power of the lower immersion heater, 0 and 6 kW respectively. An additional 3 kW is possible. See the chapter: Switching to 18 kW electric heater power.

Delay mixing valve **180 (30 – 240, blocked)**

The mixing valve delay, the period before it draws energy from the immersion heater, is set here. It can be set from 30 to 240 minutes. If the value is set to "Blocked", the mixing valve will never open to the boiler. (Blocked)

Main fuse A **20 (10 – 35)**

The property's main fuse size is set here. This setting and the fitted current sensors ensure the fuses are protected when using appliances which generate temporary power peaks, for example, cookers, ovens, engine heaters, etc. The product temporarily reduces power drawn where this type of equipment is being used.

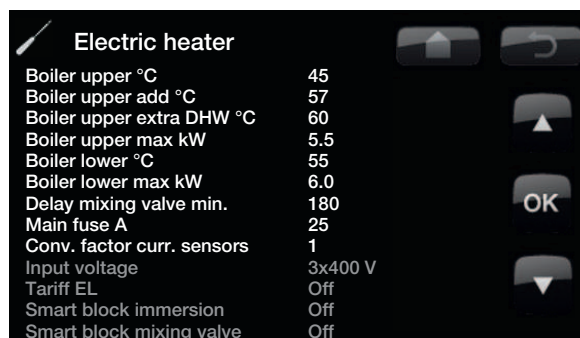

Electric heater	
Boiler upper °C	45
Boiler upper add °C	57
Boiler upper extra DHW °C	60
Boiler upper max kW	5.5
Boiler lower °C	55
Boiler lower max kW	6.0
Delay mixing valve min.	180
Main fuse A	25
Conv. factor curr. sensors	1
Input voltage	3x400 V
Tariff EL	Off
Smart block immersion	Off
Smart block mixing valve	Off

Input voltage **3x400 V**

The value is set here to indicate whether the heat pump is connected at 3x400 V, 1x230 V or 3x230 V.
Factory setting 3x400 V

Tariff EI **No (Yes /No)**

If you want the electric heater to use Tariff control.
Find out more in section entitled "Define/Remote control".

Conversion factor current sensor **1:1 (1 – 10)**

This menu contains the factor the current sensor is to use. This setting is only performed if the connection has been installed for a current sensor for higher currents.

Example: User (set) value 2 => 16 A will be 32 A.

Smart block Immersion **No (Yes/ No)**

Find out more in section "Define/Remote control/Smart Grid".

Smart block mixing valve **No (Yes/ No)**

Find out more in section "Define/Remote control/Smart Grid".

8.7.4 Upper tank

(Applies only if a heat pump has been installed.)

Stop temp HP °C **Max. (40 – 58, Max.)**

At this temperature, the heat pump stops charging the upper tank.

Start/stop diff upper °C **7 (3 – 10)**

Hysteresis before the heat pump starts or stops charging the upper tank.

Max. time upper tank **20 (10 – 150)**

This is the maximum time in minutes spent by the heat pump charging the upper tank if required in the lower tank.

Max. time lower tank **40 (10 – 120)**

This is the maximum time in minutes spent by the heat pump charging the lower tank if required in the upper tank.

Smart Low price °C **10 (Off, 1 – 30)**

Find out more in section entitled Define/Remote control/Smart Grid

Smart Over capacity °C **10 (Off, 1 – 30)**

Find out more in section entitled Define/Remote control/Smart Grid

Time Extra DHW Remote Contr. **0.0 (0.0 – 10.0)**

Time in full or half hour intervals during which the *Extra hot water* function is enabled when activated in the *Remote control* menu (*Advanced/Define system/Remote control/Extra DHW*) or when activated via a CTC SmartControl accessory. For CTC SmartControl functionality and settings, please refer to the relevant manual.

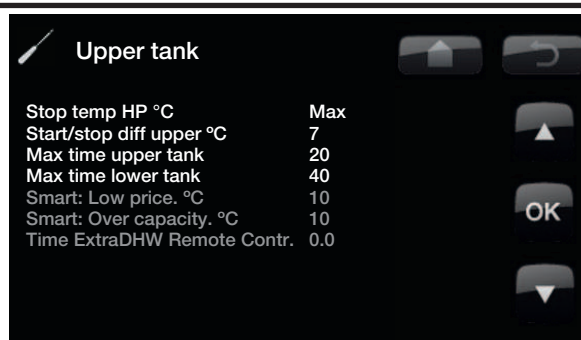

8.7.5 Communication

These settings are activated for the Superior systems and are not used in normal operation. They are not described in these instructions.

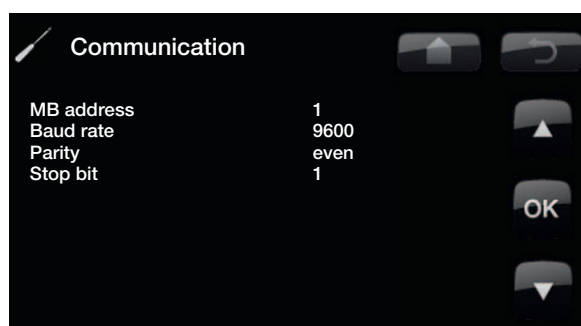

8.7.6 Cooling (accessory)

Common heating and cooling **No (No/Yes)**

The 'Yes' menu option means that free cooling and heat are distributed in the same heating system.

Condense secured? **No (No/Yes)**

If a condense pipe for the system has been secured, significantly lower temperatures are permitted at various points in the system. **WARNING** Build-up of condensation in the house structure can lead to damp and damage from mildew. In the event of doubt, contact an expert surveyor for an assessment.

Room temp cooling **25 (10 – 30)**

This is used to set the desired room temperature for cooling.

Smart Low price °C **1 (Off, 1 – 30)**

Find out more in section entitled Define/Remote control/Smart Grid

Smart Over capacity °C **2 (Off, 1 – 30)**

Find out more in section entitled Define/Remote control/Smart Grid

Ext. Block **None (NO / NC)**

The function is activated by an external control signal (Normally Open or Normally Closed). The function can be used to turn off cooling with the help of a humidity sensor when there is a risk of condensation.

NOTE: See CTC EcoComfort manual for more information.



8.7.7 Solar panels (accessories)

These settings are intended for accessory solar panels. See the CTC Solar controls/Expansion card manual for more information.

8.7.8 Sett. Diff thermostat function

The function must be defined before the settings can be entered. The operating thermostat function is used if you want to charge your system tank (e.g. EZ 250) from a water-jacketed stove, or another water source.

However, this function cannot be combined with the same function in a solar heating system (when e.g. an EcoTank is connected to an EZ 250). This is because the same outlets and sensors are used for both functions.

Information about the operating thermostat function will be displayed under Operation data.

Charge start diff. temp., °C **7 (3 – 30)**

Here you can set the temperature difference determining when charging from the heat source is started. The heat source must be this many degrees warmer than the tank temperature for charging to start.

Charge stop diff. temp., °C **3 (2 – 20)**

Here you can set the temperature difference determining when charging from the heat source is stopped. When the temperature difference between the product and the tank falls below this set value, charging stops.

Charge temperature, °C **60 (10 – 80)**

Here you can set EcoZenith/EcoHeat's maximum permitted temperature in the lower tank. The charging stops if this temperature is exceeded.

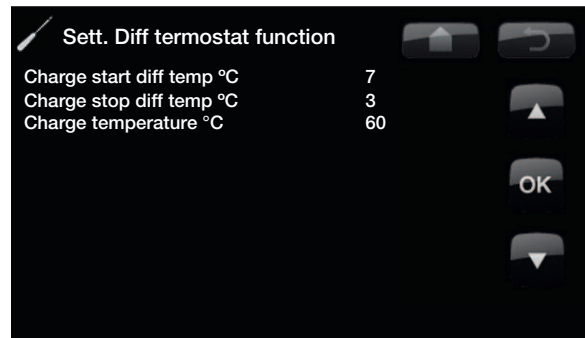

8.7.9 Pool

The settings for Pool require the installation of an expansion card (A3).

See the CTC Solar controls/Expansion card manual for more information.

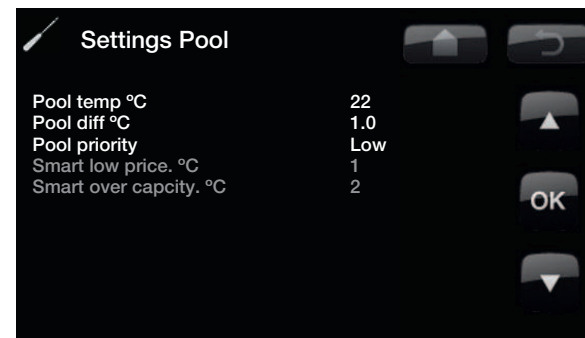

8.7.10 Saving and loading settings

The following settings can be saved and loaded.

Save settings

Here your own settings can be stored; confirm with the "OK" button.

Load settings

The saved settings can be reloaded using this option.

Load factory settings

The product is supplied with the factory values set. They can be restored by activating this function. Press OK to confirm. However, the product and product size are retained.

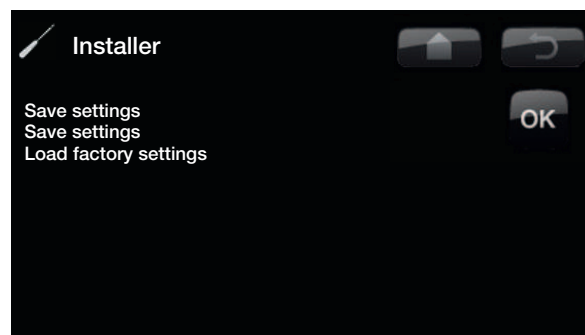

8.8 Define system



Here you can define the method of use of the product. Define functions such as: heat pump, room sensor, radiator system 2, solar heating, etc.

For more information, see the relevant function on the following pages.

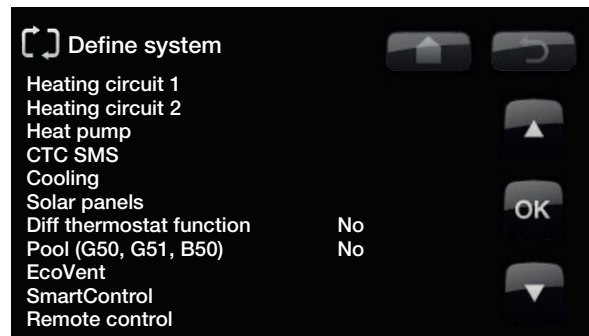

8.8.1 Def heating circuit 1 or 2

Specify whether the room sensor should be connected to the system.

Select whether the room sensor for the heating circuit is permanently *connected* or *wireless* (*Wired/Wireless*)

For information about the wireless room sensor, refer to the relevant manual.

Once the CTC SmartControl accessory has been installed/defined, a sensor from the CTC SmartControl series can also be used as a room sensor. In such a case, SmartControl must be selected from the Typemenu. For CTC SmartControl functionality and settings, please refer to the relevant manual.

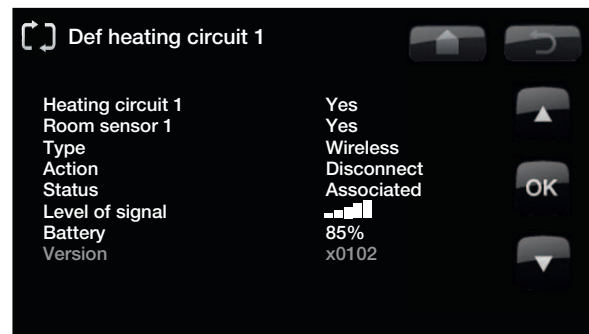
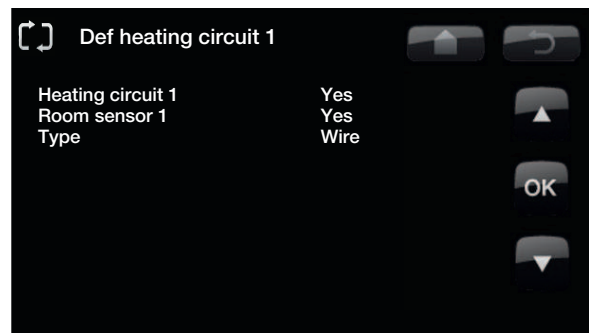

Define heat pump

Flow/level switch None/NC/NO

Specify whether or which type of level switch is installed in the system.

Choose between:

- None
- NC (Normally Closed)
- NO (Normally Open).

Flow/level switch must also be set under the section entitled "Remote control procedure".

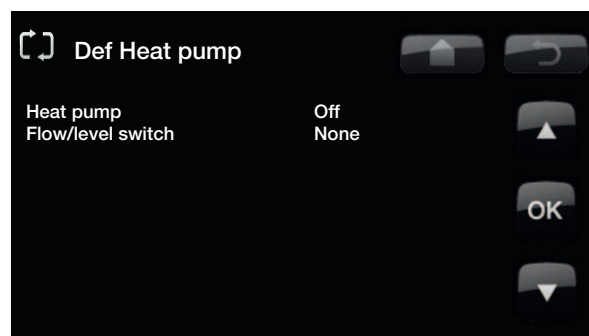

8.8.2 Define SMS (accessory)

This is for defining whether SMS control is installed (accessory).

Activate **Yes (Yes/No)**

If "Yes", the menus below will be displayed.

Level of signal

The signal strength of the reception is shown here.

Phone Number 1

The first activated phone number is shown here.

Phone Number 2

The second activated phone number is shown here.

Hardware Version

The hardware version of the SMS accessory is shown here.

Software version

The software version of the SMS accessory is shown here.

NB: For more information on the SMS function, see the "CTC SMS" manual.

8.8.3 Define cooling (accessory)

The cooling function is adjusted using primary flow sensor 2 (B2), which means that heating circuit 2 and cooling cannot be used simultaneously.

Cooling **No (No/Yes)**

This is for selecting whether cooling is installed.

See the CTC EcoComfort manual for more information.

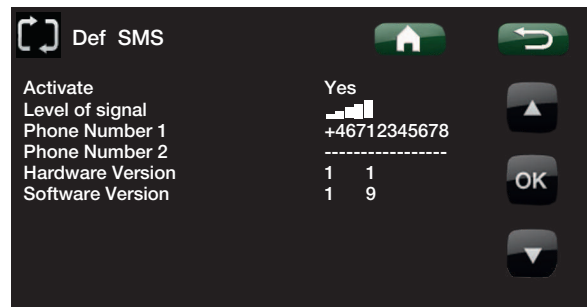

8.8.4 Def Solar panels

Solar panels

No/Yes

Specify here whether solar panels are used. This function will only work if an expansion card is connected to the product.

See the CTC Solar controls/Expansion card manual for more information.

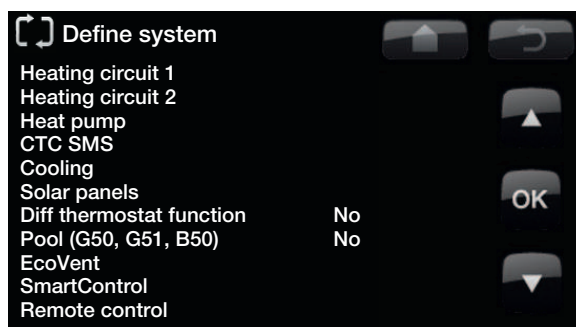

8.8.5 Define Differential thermostat function

Differential thermostat function

No/Yes

Specify here whether operating thermostat function is used. The differential thermostat function is used if you want to charge your EcoZenith from a water-jacketed stove, or another heating source.

However, this function cannot be combined with the same function in a solar heating system (when e.g. an EcoTank is connected to an EZ 250). This is because the same outlets and sensors are used for both functions.

Information about the Differential thermostat function will be displayed under Operation data.

8.8.6 Def. Pool

Specify here whether pools are used. This function will only work if an expansion card is connected to the product.

See the CTC Solar controls/Expansion card manual for more information.

8.8.7 Define CTC SmartControl (accessory)

SmartControl

CTC SmartControl components are defined in this menu. For CTC SmartControl functionality and settings, please refer to the relevant manual.

8.8.8 Define Remote Control

The remote control function in CTC's products provides a wide range of opportunities to adjust the heating externally. There are four programmable inputs that can activate the following functions:

- Heat pump tariff
- Immersion heater tariff
- Night reduction
- Ripple control
- Additional domestic hot water
- Flow/level switch
- Heating ext mode Rad 1
- Heating ext mode Rad 2
- Smart A
- Smart B
- Vent. Reduced
- Vent. Boost
- Vent. Custom
- Vent. Unoccupied
- Cooling

Terminal blocks – inputs

There are two programmable 230V inputs and two low-voltage ports on the relay card (A2).

Open terminal block = no external effect. (Normal NO).

Closed terminal block = function activated externally.

Designation	Terminal block name	Connection type
K22	A14 & A25	230 V
K23	A24 & A25	230 V
K24	G33 & G34	Low voltage (<12V)
K25	G73 & G74	Low voltage (<12V)

Remote control procedure

Assign input

First of all, an input is assigned to the function or functions to be controlled remotely.

This is done in

"Advanced/Define system/Remote Control".

Example

In the example, there is manual control of whether the heating is to be on or off in Heating System 1 (HS1).

First of all, *"Heating ext mode Rad 1"* is assigned input K24.

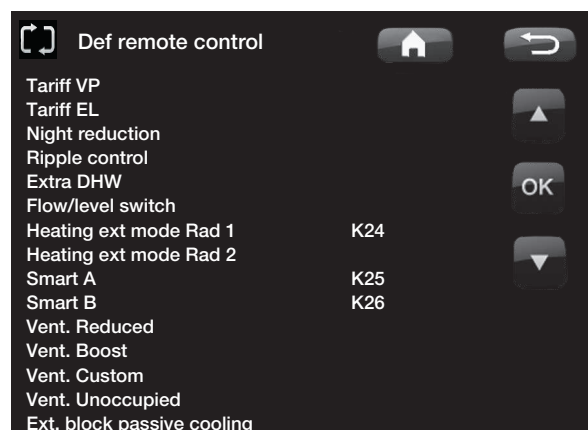

Example in which "Heating, ext. mode HS1" has been assigned terminal block "K24" for remote control.

NB: Enertech AB is NOT responsible for the required heat being produced if the remote control has blocked the heating over a long period.

8.8.8.1 Remote control procedure

When an input is assigned, the function must be activated or set in the menu *Installer/Settings/Heating circuit*.

When this has been done, you programme what is to happen at Remote Control/Heating, external mode HS1 (closed input, arrow 2).

Arrow 2 indicates the selection "Off".

So in this example the heating is always on. (Normal mode). The radiator pump is switched on continuously, the mixing valve operates to maintain its "setpoint value"

But when K24 is closed, the radiator pump stops and the mixing valve closes. The heating remains switched off until you choose to start heating up by opening K24.

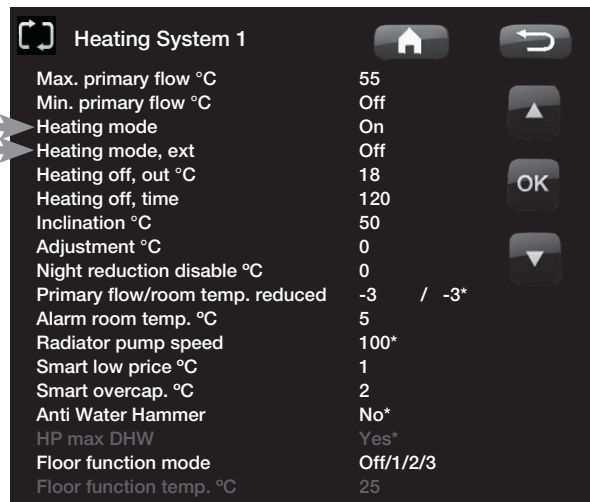

Example in which "Heating mode" is normally "On" in the heating season, but when terminal block K24 is closed "Off" is activated and the heating is switched off.

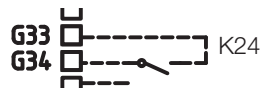

Open terminal block = "On" (in this example)

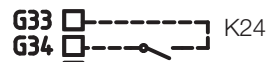

Closed terminal block = "Off" (in this example)

NB: Enertech AB is NOT responsible for the required heat being produced if the remote control has blocked the heating over a long period.

The functions in remote control.

HP tariff

When electricity suppliers use a differentiated tariff, you have the opportunity to block the heat pump when the electricity tariff is high.

Electricity tariff*.

When electricity suppliers use a differentiated tariff, you have the opportunity to block the immersion heater(s) when the electricity tariff is high.

Night reduction

Night reduction means that you reduce the temperature indoors during scheduled periods, for example at night or when you are at work.

Ripple control

Disconnecting the compressor and immersion heater during a certain period which is defined by the electricity supplier (special equipment).

Ripple control is a device which an electricity supplier can fit with the aim of disconnecting high current draw equipment for a short period of time. The compressor and electrical power are blocked when ripple control is active.

Additional Domestic Hot Water

Select this option if you want to activate the *Extra DHW* function.

NB: Enertech AB is NOT responsible for the required heat being produced if the remote control has blocked the heating over a long period.

Flow/level switch

In some cases, extra protection is required due to local requirements or provisions. For example, the requirement in some areas is for the system to be installed within a water catchment area. The pressure/level switch is defined in the *Installer/Define system/Def. Heat pump* menu. If there is a leak, the compressor and brine pump stop and the Flow/level switch alarm appears on the display.

Heating, ext. mode HS1

Heating, ext. mode HS2

With remote controlled "Heating, etc. mode", "On" is selected if the heating is to be on or "Off" if the heating is to be switched off. "Auto" mode can also be selected.

Read more in the section entitled "Your home's heating curve".

Smart A

Smart B

Smart Grid offers an opportunity to control from the outside whether heating is to be calculated as normal price, low price or overcapacity. The heat pump and immersion heater can also be blocked in a way similar to "Ripple control".

Vent. Reduced,

Vent. Boost,

Vent. Custom,

Vent. Unoccupied

Ext. block passive cooling

NB: Enertech AB is NOT responsible for the required heat being produced if the remote control has blocked the heating over a long period.

Smart Grid

The "Smart Grid" function selects different heating options depending on the price of energy using accessories from the energy supplier.

Smart Grid is based on the energy price being calculated as

- Normal price
- Low price
- Overcapacity
- Blocking

Room temperature, pool temperature and hot water temperature, etc. are given different heating temperatures depending on the energy price.

Procedure:

First of all, Smart A and Smart B are assigned a separate input in the menu *Installer/Define system/Def. Remote control/Smart A/B*.

Activation then takes place based on the terminal blocks' closure and settings for each function.

- Normal price: (Smart A: Open, Smart B: Open).
No effect on the system.
- Low price mode: (Smart A: Open, Smart B: Closed).
- Overcapacity mode:
(Smart A: Closed, Smart B: Closed).
- Blocking mode: (Smart A: Closed, Smart B: Open)

In each function that can be controlled there is a choice of temperature change for low price mode and overcapacity mode.

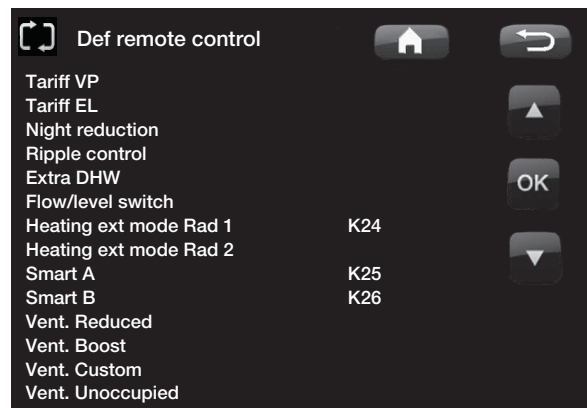

Example in which Smart A has been assigned low voltage input K24 and Smart B has been assigned low voltage input K25.

NB: Enertech AB is NOT responsible for the required heat being produced if the remote control has blocked the heating over a long period.

8.8.8.2 Smart Grid

Factory setting for low price is 1°C increase in temperature.

Factory setting for overcapacity is 2°C increase in temperature.

Smart low price °C	1 (Off, 1-5)
Smart overcap. °C	2 (Off, 1-5)

Alternative setting range 1-30°

The following can be controlled:

- Room temperature heating systems 1-2
- Primary flow temperature heating systems 1-2
- Upper tank
- Pool
- Cooling

Comment re. cooling

When active cooling = setpoint has not been reached.

E.g. 26.0 (25.0)

In these cases Smart Grid "Normal mode" is activated for the heating systems. (Smart low price or smart overcapacity is not activated).

The reason for this is to avoid a conflict between heating and cooling. For example, if there is a standard 2 °C difference between heating and cooling, you do not want to heat and cool at the same time.

NB: Enertech AB is NOT responsible for the required heat being produced if the remote control has blocked the heating over a long period.

Low price mode: (A: Open, B: Closed).

- With room sensor: Room temp. (setpoint) increased by 1°C (Factory setting, Smart low price °C)
- Without room sensor: Primary flow (setpoint) increased by 1°C (Factory setting, Smart low price °C)
- Upper tank: Setpoint increased by 10°C (Factory setting, Smart low price °C)
- Pool: Pool temp. increased by 1°C (Factory setting, Smart low price °C)
- Cooling. Room temperature is reduced by 1°C (Factory setting, Smart low price °C)

Blocking mode: (A: Closed, B: Open).

- The heat pump and immersion heater can be blocked in accordance with the settings in heat pump and immersion heater.
- **Smart blocking hp No (Yes/No)**
Blocks heat pump
Advanced/Settings/Heat pump
- **Smart blocking immersion No (Yes/No)**
Blocks immersion heater
Advanced/Settings/Immersion heater
- **Smart blocking mixing valve No (Yes/No)**
Blocks bivalent mixing valve so that it does not pass 50%. If the mixing valve has passed 50% when blocking starts, the mixing valve remains in the upper tank. If demand falls and the mixing valve closes, it may not open more than 50%.

NB: Enertech AB is NOT responsible for the required heat being produced if the remote control has blocked the heating over a long period.

Overcapacity mode: (A: Closed, B: Closed).

- With room sensor: Room temp. (setpoint) is increased by 2°C (Factory setting, Smart overcap. °C)
- Without room sensor: Primary flow (setpoint) is increased by 2°C (Factory setting, Smart overcap. °C)
- Upper tank: Immersion heater
Setpoint is "Min. temp °C + increase of 10°C (Factory setting, Smart overcap. °C)
- Lower tank: Heat pump
The heat pump only operates in the lower tank.
Calculated setpoint increases by 2°C (Factory setting, Smart overcap. °C)
- Pool: Pool temp. is increased by 2°C (Factory setting, Smart overcap. °C)
- Cooling. Room temperature is reduced by 2°C (Factory setting, Smart overcap. °C)
(EcoZenith 550; Heating System 2 is not affected)

NB: Enertech AB is NOT responsible for the required heat being produced if the remote control has blocked the heating over a long period.

8.9 Service



! NB: This menu is intended for the installer only.

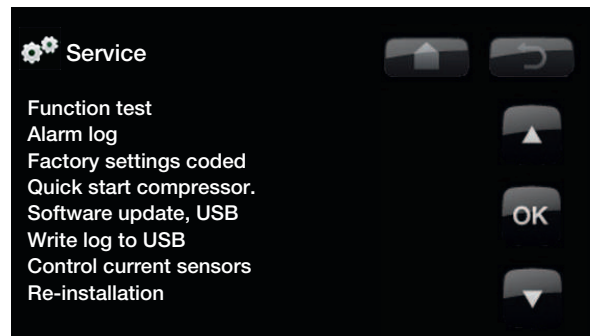

8.10 Function test

From this menu, the installer can test the connection and function of separate components of the heating system. When this menu is activated, all control functions are stopped. The only protection against incorrect operation are the pressure sensors and the immersion heater's overheating protection device. When you exit the menu, the heat pump returns to normal operation. A return to normal operation follows after 10 minutes' inactivity.

When function test starts, all automatics stop and the test can be carried out.

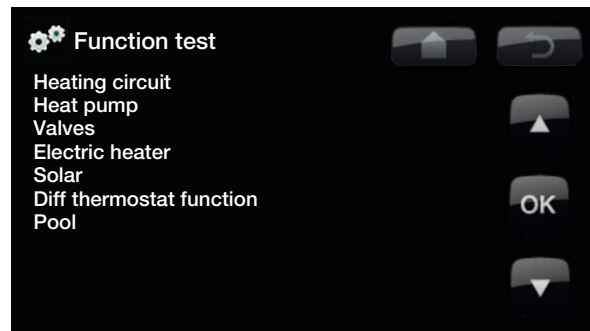

■ When you exit the menu, CTC EcoZenith returns to the start menu.

8.10.8.1 Test heating circuit

If two radiator systems are installed, the values for both are displayed here.

Mixing valve

Opens and closes the mixing valve. (Open/Close)

Rad pump

Starts and stops the radiator pump. (On/Off)

LED room sensor

The room sensor alarm function can be controlled from here. When activated, the room sensor's red LED comes on steady.

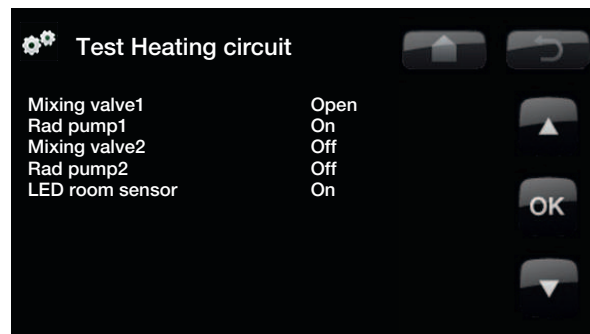

8.10.8.2 Test Heat pump

Function test carried out on the heat pump.

HP Compr. (On/Off)

(On/Off) This is where the function test is carried out on the compressor. The fan or brine pump and charge pump are also operating so that the compressor is not going to trigger its pressure switches.

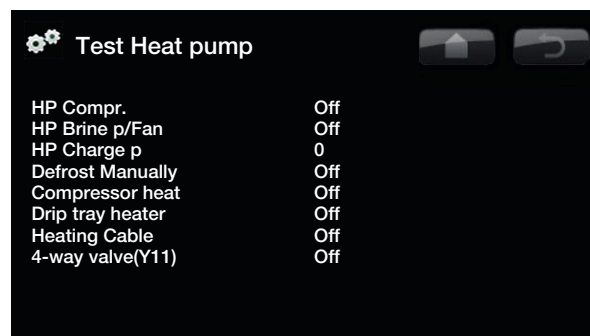

HP Brine pump/Fan (On/Off)

(On/Off) Activation of the fan or brine pump.

HP Charge pump (On/Off)

(On/Off) Function test 0–100%.

Manual defrosting (Applies to the CTC EcoAir only)

Manual defrosting function test (On/Off)

Compressor heater(Applies to the CTC EcoAir only)

Compressor heater function test (On/Off).

Heater condensation tray(Applies to the CTC EcoAir only)

Heater condensation tray function test (On/Off).

Heating cable(Applies to the CTC EcoAir only)

Heating cable function test. (Accessory) (On/Off)

4-way valve (Applies to the CTC EcoAir only)

4-way valve function test (On/Off).

8.10.8.3 Test Valves

Function test carried out on the flow conditioner. Flow test (Up/Down) (upper and lower parts of the tank respectively).

8.10.8.4 Test Elec.heater

You use this function to test the immersion heater’s phases: L1, L2 and L3.

The modes available are On/Off.

8.10.8.5 Test Solar

This function will only work if an expansion card (A3) is connected to the product. See the CTC Solar controls/Expansion card manual for more information.

8.10.8.6 Test differential thermostat function

Pump transfer (G46) (On/Off)

Charge pump function test.

8.10.8.7 Test Pool

This function will only work if an expansion card (A3) is connected to the product. See the CTC Solar controls/Expansion card manual for more information.

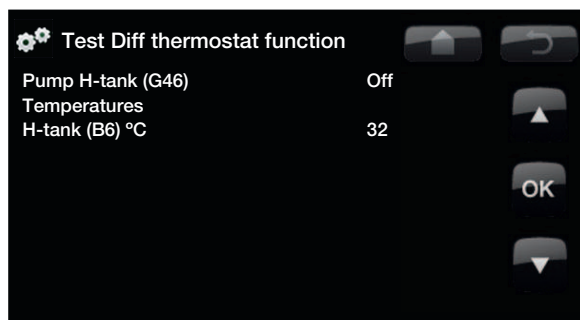
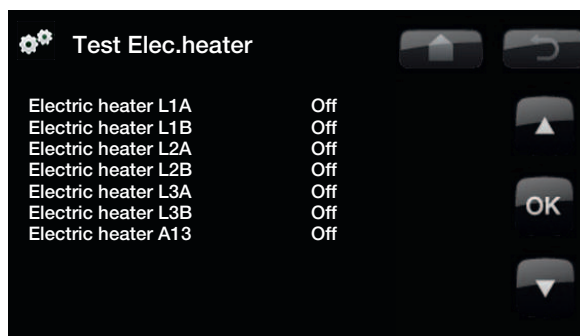
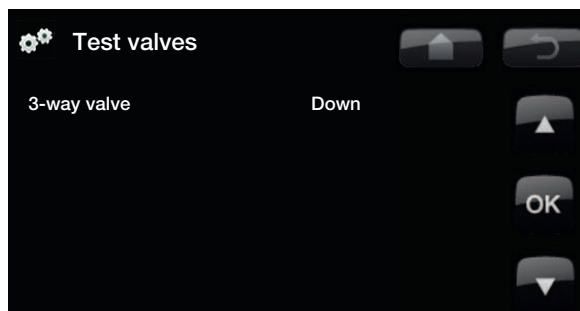
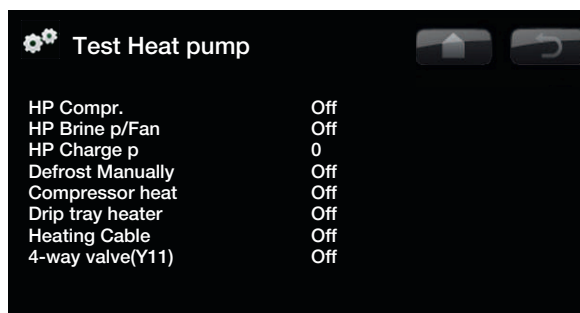

8.11 Alarm log

You can use this to read information about the latest alarms. The latest alarm is displayed at the top and the four latest alarms are shown under Stored alarms.

An alarm which reoccurs within an hour is ignored so as not to fill up the log. If all the alarms are the same, this can indicate that there is an intermittent fault, e.g. a loose contact.

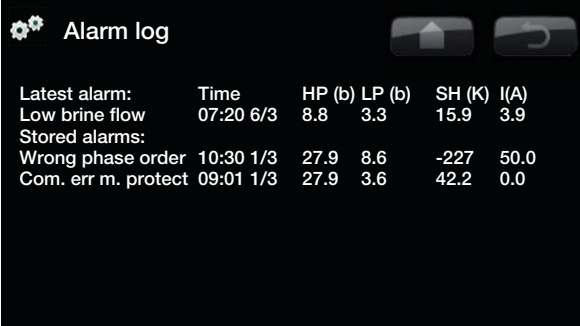

Latest alarm:	Time	HP (b)	LP (b)	SH (K)	I(A)
Low brine flow	07:20 6/3	8.8	3.3	15.9	3.9
Stored alarms:					
Wrong phase order	10:30 1/3	27.9	8.6	-227	50.0
Com. err m. protect	09:01 1/3	27.9	3.6	42.2	0.0

! NB: Only an authorised service engineer is allowed to log in to the Factory settings coded option. Severe operational problems and faults may occur affecting the product if values are amended without authorisation. Note that in such cases the warranty terms do not apply.

Factory settings coded

This menu is intended to set the manufacturer's operational and alarm limits. A 4-digit code must be specified to be able to amend these limits. However, you can also take a look without any code to see what options feature in the menu.

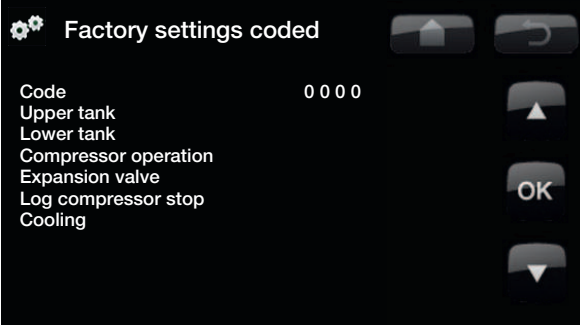

Factory settings coded	
Code	0 0 0 0
Upper tank	
Lower tank	
Compressor operation	
Expansion valve	
Log compressor stop	
Cooling	

Quick start compressor

(Applies only if heat pump is installed.)

When starting up the product, the compressor's start is delayed by 10 minutes. This function speeds up this process.

Software update, USB

This is only for service engineers. This option can be used to update the software in the display via USB. The software update process is complete when the start menu appears.

Write log to USB

This is only for service engineers. This function can be used to save logged values to a USB memory stick.

Control current sensors

This is for identifying which current sensor is connected to the relevant phase.

All three currents (L1, L2 and L3) will appear in the current operational data when CTC EcoZenith i250 has identified the current transformers' relevant phases.

When activating the function "Control current sensors" it is important that you have switched off any major consumers of electricity in the house. Also make sure that the backup thermostat in CTC EcoZenith i250 is turned off.

Re-installation

This command re-launches the installation sequence. See the chapter on First start.

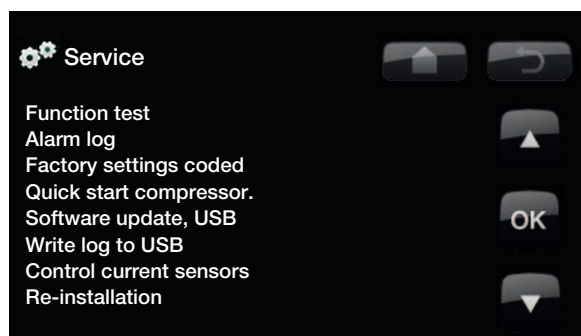

! NB: The power to the product must not be interrupted, under any circumstances, during the update process.

! NB: Turn off the power and always restart the product after the program update! Several minutes may pass before the display communicates clearly after restart.

9. Operation and Maintenance

When the installer has installed your new system, you should check along with the installer that it is in perfect operating condition. Let the installer show you where the switches, controls and fuses are so that you know how the system works and how it should be maintained. Bleed the radiators after around three days of operation and top up with water if required.

Boiler and radiator system safety valve

Check around four times a year that the valve is working by manually turning the control. Check that water is coming out of the safety valve discharge.

Mixing Valve

The mixing valve is operated automatically from the control system, ensuring that the radiators reach the correct temperature, no matter what season it is. However, where a fault occurs, you can operate the valve by pulling out the knob on the motor and turning it clockwise to reduce the temperature or anticlockwise to increase it.

Draining the tank

The CTC EcoZenith should be disconnected from the power source when it is being drained. The drain valve is positioned at the bottom left of the unit when viewed from the front, behind the front of CTC EcoZenith. When draining the whole system, the mixing valve should be fully open, i.e. turned anticlockwise as far as it will go. Air must be supplied to the closed system.

Operation stop

The CTC EcoZenith i250 is shut down using the operating switch. If there is a risk of the water freezing, all the water should be drained from the heat pump and the radiator system (see drainage above).

The DHW circuit, which contains around five litres, must also be emptied. Disconnect the cold water connection to CTC EcoZenith i250. Feed a hose into the cold water connection to CTC EcoZenith i250. The hose must go down to the bottom of the coil for all the water to be drained. Draining is carried out by siphoning out the water.

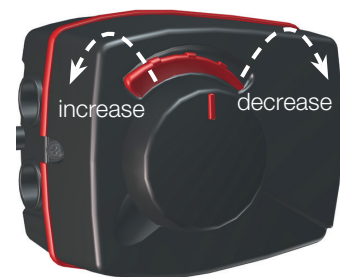

i Do not forget to re-set the mixing valve to the automatic position by pushing in the knob again.

10. Troubleshooting/appropriate measures

The CTC EcoZenith i250 is designed to provide reliable operation and high levels of comfort, and to have a long service life. Various tips are given below which may be helpful and guide you in the event of an operational malfunction.

If a fault occurs, you should always contact the installer who installed your unit. If the installer believes the malfunction is due to a materials or design fault, then they will contact Enertech AB to check and rectify the issue. Always provide the product's serial number.

DHW

Many people want to gain maximum benefit from the CTC EcoZenith i250's low operating costs.

The control system is equipped with three comfort levels for hot water. We recommend starting at the lowest level and if there is not enough hot water, increase it to the next level. We also recommend that you operate a regular hot water pattern.

Check that the hot water temperature is not being affected by a poor mixing valve, whether in the CTC EcoZenith i250 or possibly the shower mixer.

The Heating System

A room sensor, which should be fitted when possible, ensures that the temperature in the room is always suitable and stable. For optimal running, radiator thermostats should always be fully open in the area where the room sensor is located.

A correctly operating heating circuit is of significant importance to the heat pump's operation and affects energy savings.

When adjusting the system, always do so with all radiator thermostats fully open. The thermostats can be individually adjusted after a few days in rooms where lower temperatures are desired.

■ Avoid running hot water at the highest flow capacity. If you run a bath at a rather slower rate instead, you will get a higher temperature.

■ Avoid placing the room sensor close to the stairway due to the uneven air circulation.

■ If you do not have radiator thermostats on the upper floor, you may need to install them.

If you do not achieve the set room temperature, check:

- that the radiator system is correctly adjusted and is functioning normally. that radiator thermostats are open and the radiators are equally warm all over. Touch the entire radiator surface. Bleed the radiators. The CTC EcoZenith i250's economical operation demands a radiator system that functions effectively.
- that CTC EcoZenith is operating and no error messages are displayed.
- that there is sufficient electrical power available. Increase if necessary. Also check that the electric power output is not limited due to excessively high electricity loads in the property (load monitor).
- that the product is not set to the "Max. allowed primary flow temperature" mode with a too low set value.
- that "Primary flow temperature at -15°C outdoor temperature" is set sufficiently high. Increase if necessary. More can be read about this in the chapter on The house heating curve. However, always check the other points first.
- that the temperature reduction is set correctly. See Settings/Radiator system.
- that the mixing valve is not in the manual position.

If the heat is not even, check:

- that the placement of the room sensors is appropriate for the house.
- that the radiator thermostats don't interfere with the room sensor.
- that no other heat sources/cold sources interfere with the room sensor.
- that the mixing valve is not in the manual position.

Current Monitor

The CTC EcoZenith i250 has an integrated current monitor. If the system is fitted with a current sensor, the property's main fuses are continuously monitored to ensure they are not overloaded. If this should happen, electric stages are disconnected from the CTC EcoZenith.

The electrical power of the CTC EcoZenith i250 may be restricted where high heating requirement levels are combined with, for example, single-phase motor heaters, cookers, washing machines or tumble dryers. This may result in inadequate heating or hot water temperatures. If the CTC EcoZenith is restricted, "High current, elpower redu (X A)" appears in text form in the display. Consult an electrician to determine whether the fuse size is correct or the three phases in the house are evenly loaded.

Air problems

If you hear a rasping sound from the tank, check that it has been properly bled. Turn the boiler vent valve so that any air can be evacuated. Top up with water where required, so that the correct pressure is achieved. If this noise recurs, call a technician to check the cause.

Unusual noise when shutting off DHW

In some cases, unusual noises may be produced by the house's pipe system and the CTC EcoZenith i250 due to the jolts which occur when the flow is quickly interrupted. There is no fault with the product, but the noise may occur when older model outlets are used. More recent outlets are often fitted with a soft-closing mechanism. If an unusual sound comes from hard-closing dishwasher and washing machines, this can be remedied using a shock arrestor. A shock arrestor can also be an alternative to soft-closing water taps.

Motor protection (when heat pump is connected)

The CTC EcoZenith i250 constantly monitors the compressor's operating current and an alarm is triggered if the compressor is using an unusually high current. When a fault occurs the message "Motor protect high current" is displayed.

The cause of the fault may be as follows:

- Phase failure or mains interruption. Check the fuses, which are the most common cause.
- Compressor overload. Call out a service engineer.
- Faulty compressor. Call out a service engineer.
- Inadequate circulation between the heat pump and boiler. Check the heat medium pump (left pump, viewed from front). Call out a service engineer.
- Abnormally high temperature in the brine circuit. Call out a service engineer.

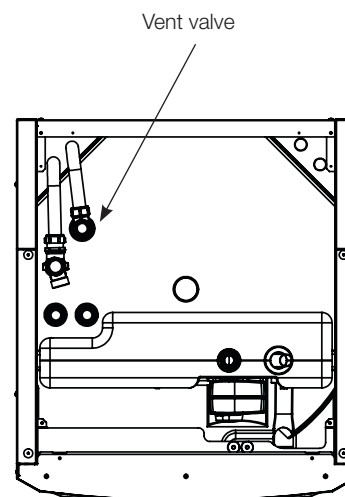

! Don't forget that the radiators may also need bleeding.

10.1 Information messages

Information messages are displayed when appropriate and are intended to inform users about various operational situations.

[I013] Start delay

[I002] Heating off, heating sys. 1

[I005] Heating off, heating sys. 2

Indicates that the product is in Summer mode. No need for heating in the current heating system, only hot water.

[I008] Tariff, HP off.

Indicates that Tariff has switched off the heat pump.

[I009] Compressor blocked

The compressor is set to be shut down, e.g. before drilling or digging has been carried out for the collector coils. The product comes with the compressor shut off. This option is selected under the Installer/Settings/Heat pump menu.

[I010] Tariff, EI. off.

Indicates that Tariff has switched off the immersion heater.

[I011] Ripple control

Indicates that ripple control is active. Ripple control is a device which can be fitted by an electricity supplier in order to disconnect equipment with a high rate of electricity consumption for a short period of time. Not currently in use in the UK. The compressor and electrical output are blocked when ripple control is active.

[I012] High current, reduced electricity

- The property's main fuses risk being overloaded due to, for example, the simultaneous use of several power-hungry appliances. The product reduces the immersion heaters' electrical output during this period.
- 2h max. 6 kW. Electric heating elements are limited to 6 kW for 2 hours after being switched on. This message appears if more than 6 kW are required during the product's first 2 hours of operation. This is applicable after a power outage or a new installation.

[I013] Start delay

The compressor is not allowed to start too quickly after it has stopped. The delay is usually at least 10 minutes.

[I014] Drying period active, d

Indicates that the floor function is active and displays the time (days) remaining that the function will be active.

[I017] Smart: Block

[I018] Smart: Over capacity.

[I019] Smart: Low price.

Product functionality is governed by "Smartgrid". Also see *Define system/Remote control/Smartgrid*.

[I021] Ext. Ctrl Heating 1

[I022] Ext. Ctrl Heating 2

Remote control governs whether the heat in the heating system is to be switched on or off. If the heating is switched off, "Heating off, heating circuit 1/2" is also displayed.

[I028] Holiday period

Displayed when setting the holiday schedule, which entails lowering the room temperature and that no hot water is produced.

[I030] Driver block under voltage

The heat pump has stopped due to under voltage. The product will make a new attempt to start.

[I031] Driver block alarm

The heat pump has stopped due to a driver fault; for example over voltage or too high temperature. The product will make a new attempt to start.

10.2 Alarm texts



If a fault occurs with a sensor, for instance, an alarm is triggered. A message appears on the display with information about the fault.

You reset the alarm by pressing the Reset alarm button on the display.

If several alarms are triggered, they are displayed one after the other. An outstanding fault cannot be reset without being rectified first. Some alarms are reset automatically if the fault disappears.

The description below also includes an alarm for connected heat pump.

Alarm text	Description
[E010] Compressor type?	This message appears if there is no information about the compressor type.
[E013] EVO off	This message appears when there is a fault with the expansion valve control. Contact your installer.
[E024] Fuse blown	This message appears when fuse F1 or F2 has been triggered.
[E026] Heatpump	This message appears if the heat pump is in alarm mode.
[E035] High pressure switch	The refrigerant's high pressure switch has been triggered. Press reset and check whether the alarm recurs. If the fault recurs, contact your installer.
[E040] Low brine flow	Low brine flow is very often due to air in the collector system, particularly just after installation. Collectors which are too long can also be a cause. Also check that the brine pump is set to the fastest speed. Press reset and check whether the alarm recurs. Also check the brine filter that has been installed. If the fault recurs, contact your installer.
[E041] Low brine temp	Incoming brine temperatures from borehole/ground loop are too low. Press reset and check whether the alarm recurs. If the fault recurs, contact your installer to check the dimensions of the cold side.
[E044] Stop, high compr temp	This message appears when the compressor temperature is high. Press reset and check whether the alarm recurs. If the fault recurs, contact your installer.
[E045] Stop, low evaporation	This message appears when the evaporation temperature is low. Press reset and check whether the alarm recurs. If the fault recurs, contact your installer.
[E046] Stop, high evaporation	This message appears when the evaporation temperature is high. Press reset and check whether the alarm recurs. If the fault recurs, contact your installer.

Alarm text	Description
[E047] Stop, low suct gas exp.	<p>This message appears when the suction gas temperature is low.</p> <p>Press reset and check whether the alarm recurs. If the fault recurs, contact your installer.</p>
[E048] Stop, low evapor exp.	<p>This message appears when the expansion valve's evaporation temperature is low.</p> <p>Press reset and check whether the alarm recurs. If the fault recurs, contact your installer.</p>
[E049] Stop, high evapor exp.	<p>This message appears when the expansion valve's evaporation temperature is high.</p> <p>Press reset and check whether the alarm recurs. If the fault recurs, contact your installer.</p>
[E050] Stop, low superheat exp. Low superheat exp. valve	<p>This message appears when the expansion valve's superheat temperature is low.</p> <p>Press reset and check whether the alarm recurs. If the fault recurs, contact your installer.</p>
[E052] Phase 1 missing [E053] Phase 2 missing [E054] Phase 3 missing	<p>This message appears in the event of a phase failure. Call in a specialist to check the cause.</p>
[E055] Wrong phase order	<p>The product's compressor motor must rotate in the right direction. The product checks that the phases are connected correctly; otherwise, an alarm is triggered. In this case, two of the phases to the product need to be changed. The power supply to the system must be shut off when rectifying this fault. This fault generally only occurs during installation.</p>
[E057] Motor protect high curr.	<p>High current into the compressor has been detected. Press reset and check whether the alarm recurs. If the fault recurs, contact your installer.</p>
[E058] Motor protect low curr.	<p>Low current into the compressor has been detected. Press reset and check whether the alarm recurs. If the fault recurs, contact your installer.</p>
[E061] Max thermostat	<p>This alarm message appears if the product becomes too hot.</p> <p>During installation, make sure the max. thermostat (F10) has not been triggered as there is a chance of this occurring if the boiler has been stored in extremely cold temperatures, Reset it by pressing in the button on the electrical switchboard behind the front panel.</p>
<ul style="list-style-type: none"> • [E027] Communication error HP • [E063] Comm. error PCB • [E021] Ext. Motor protection • [E086] Comm error EXPANSION 	<p>This message appears when the display card (A1) cannot communicate with the heatpump control board (A5).</p> <p>This message appears when the display card (A1) cannot communicate with the PCB (A2).</p> <p>This message appears when the heatpump control board (A5) cannot communicate with motor protection (A4).</p> <p>This message is displayed when the display card (A1) cannot communicate with CTC Solar controls/Expansion card (A3)</p>

Alarm text	Description
[Exxx] 'sensor'	<p>An alarm message is displayed if an error occurs with a sensor that is not connected or has short-circuited and if the value is outside the sensor's range. If this sensor is important to the system's operation, the compressor stops. This requires the alarm to be reset manually after the fault has been rectified. The alarm is reset automatically after correction for the following sensors:</p> <p>[E031] Sensor prim flow 1 (B1) [E032] Sensor prim flow 2 (B2) [E030] Sensor outdoor (B15) [E074] Room sensor 1 (B11) [E075] Room sensor 2 (B12) [E005] Sensor brine out [E003] Sensor brine in [E028] Sensor HPin [E029] Sensor HPout [E037] Sensor discharge [E080] Sensor suction gas [E036] Sensor high pressure [E043] Sensor low pressure. [E137] Sensor Diffthermostat (B46) [E138] Sensor EcoTank bottom [E139] Sensor EcoTank top)</p>
[E087] Driver	Driver fault.
[E088] Driver: 1 -	Press reset and check whether the alarm recurs.
[E109] Driver: 29	If the fault recurs, contact your installer and tell them the error code number where applicable.
[E117] Driver: Offline	Communication error. The electrical connection box and driver of the heat pump are not communicating.
[E135] Risk of freezing	Alarm indicating that the temperature of the outgoing water from the heat pump (HP out) is too low for defrosting. The water volume in the system may be too low. The flow may be too low. (Applies to EcoAir)
[E152] 4-way valve	This alarm is displayed if a fault occurs with EcoAir's 4-way valve or if the connection pipes to the EcoAir are incorrectly connected. Press reset and check whether the alarm recurs. If the alarm recurs, check that the charge pump is pumping water to the heat pump's lower connection. If the fault recurs, contact your installer.
[E163] Defrost max time duration	The heat pump has not been able to end Defrosting during set time. Ensure that any ice on the evaporator has disappeared.

11. Installation

! CTC EcoZenith i250 is only approved for installation together with CTC Heat pumps. For more information, see the section entitled “Congratulations on your new product”.

! The product must be transported and stored in an upright position.

This chapter is aimed at anyone responsible for one or more of the installations required to ensure that the product works the way the property owner wants.

Take your time going through functions and settings with the property owner and answer any questions. Both you and the CTC EcoZenith i250 benefit from a user who has completely understood how the system operates and should be maintained.

11.1 Transportation

Transport the unit to the installation site before removing the packaging. Handle the product in the following manner:

- Forklift
- Lifting eye that has been fitted to the lifting sleeve on top of the CTC EcoZenith i250. An extra sleeve can be found in the middle, under the insulation.
- Lifting band around the pallet. **NB:** Can only be used with the packaging on.

Remember that the CTC EcoZenith i250 has a high centre of gravity and should be handled with caution.

11.2 Unpacking

Unpack the CTC EcoZenith i250 when it is placed next to its installation site. Check that the product has not been damaged in transit. Report any transport damage to the carrier. Also check that the delivery is complete according to the list below.

11.3 Standard delivery

- CTC EcoZenith i250 system tank with factory-installed charge pump for connection of heat pump.
- Connected electrical wiring
 - The power supply cable 3m. (Internal 1.1 m)
 - primary flow sensor, NTC 22k, 2.5 m
 - return flow sensor, NTC 22k, 2.5 m
- Kit bag containing:
 - Installation and Maintenance Manual
 - Outdoor sensor, cable length 15 m
 - Room sensor
 - Safety valve 9 bar (clean water)
 - Current sensor, 3 off
 - 2 x cable ties
 - Insulation EPP centre 41 mm.
 - Support sleeve 22x1 cu

! Recycling

! The packaging must be deposited at a recycling station or with the installation engineer for correct waste management.

At the end of the product's life cycle, it must be recycled in a correct way and be transported to a waste station or reseller offering a service of that type. Disposing of the product as household waste is not permitted.

It is of great importance that the product's refrigerant, compressor oil and electrical/electronic equipment are properly disposed of.

12. Pipe installation

The installation must be carried out in accordance with current standards and regulations. Refer to the Warm and Hot Water Installation Instructions 1993. The product must be connected to an expansion vessel in an open or closed system.

Do not forget to flush the radiator system clean before connection. Apply all the installation settings based on the description in the chapter "First start".

12.1 Filling

Filling valve (no. 90, see schematic diagram on next page) is connected to the radiator return pipe. Alternatively, the valve can be installed in the direction of the expansion pipe. When the boiler and system are being filled with water, the mixing valve (Y1) must be fully open. Pull out the knob on the valve and turn it anticlockwise as far as you can. Do not forget to push and set the knob on the valve to automatic mode after filling.

If the heat pump is not connected, connections 1 and 2 must be capped when filling with water. (See figure)

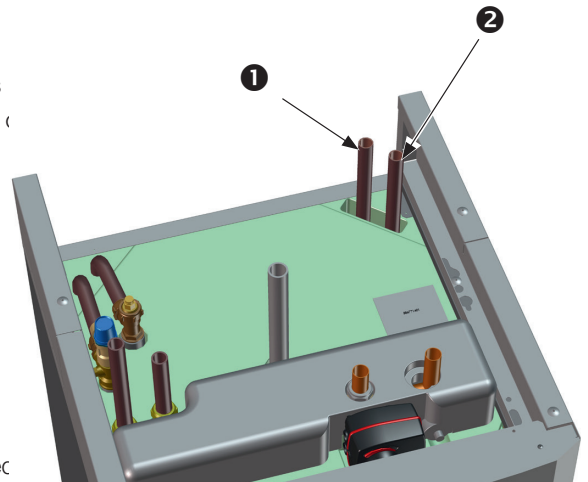

12.1.1 Pressure drop in mixing valve

The diagram below shows a drop in pressure in the mixing valve.

Start with the heat requirement in kW (e.g. 15 kW), then move vertically to the selected Δt (e.g. 10 °C). Then move horizontally to the line for the CTC EcoZenith i250 mixing valve = line 6.3 DN20. The reading for the pressure drop is taken from the scale directly below (4 kPa). For CTC EcoZenith i250, see valve DN20.

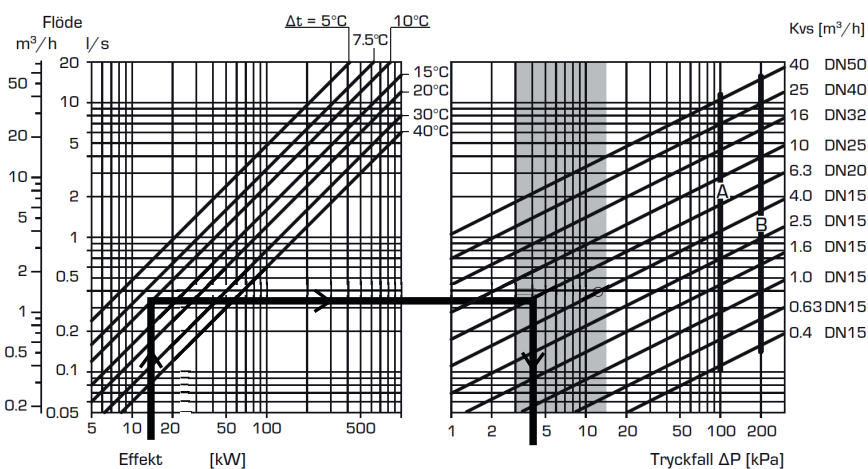

12.1.2 Pump curve charge pump

The diagram below shows the pump curve for the factory-installed charge pump for a Grundfos UPM2 15-60 130 heat pump.

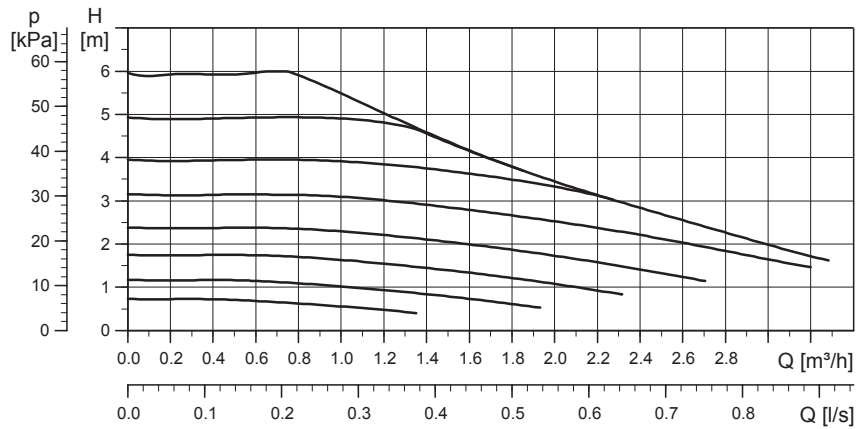

Pump curve charge pump 15-75, 130 (Accessories)

The diagram below shows the pump curve for CTC accessory item no. 586988301 Grundfos UPMS 15-75 130 pump.

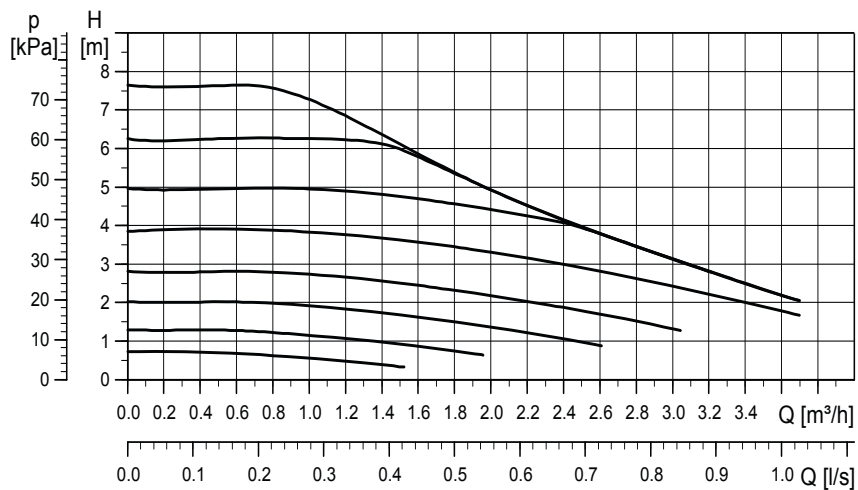

12.2 Schematic diagram

This shows the main connection between the CTC EcoZenith i250 and the property's radiator and hot water system. Different installations and systems may look different, such as a one- or two-pipe system, which means that the finished installation may be different.

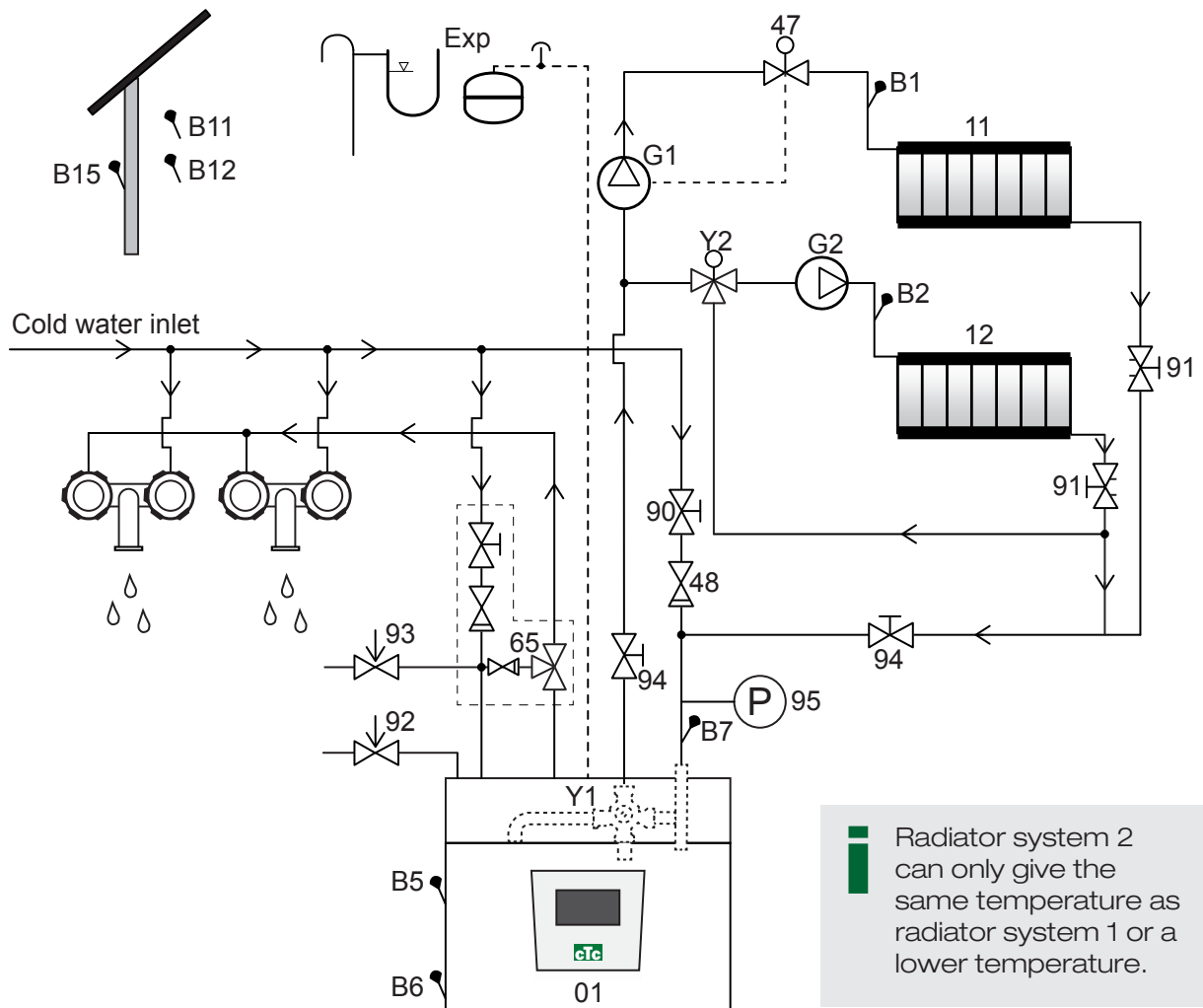

- | | | | |
|-----|---|----|--|
| 01 | CTC EcoZenith i250 | Y2 | Mixing valve, radiator system 2 |
| B1 | Primary flow sensor for radiator system 1 | 11 | Radiator system 1 |
| B2 | Primary flow sensor for radiator system 2 | 12 | Radiator system 2 |
| B5 | Sensor upper tank | 47 | Electric shut-off valve for radiator system |
| B6 | Sensor lower tank | 48 | Non-return valve for incoming cold water |
| B7 | Sensor, radiator return | 65 | Mixing valve for DHW |
| B11 | Room sensor 1 | 90 | Filling valve, radiator system |
| B12 | Room sensor 2 | 91 | Adjustment valves for radiator coils |
| B15 | Outdoor sensor | 92 | Boiler safety valve (factory-installed), 2.5 bar |
| G1 | Circulation pump, radiator system 1 | 93 | Safety valve for DHW |
| G2 | Circulation pump, radiator system 2 | 94 | Shut-off valve |
| Y1 | Mixing valve, bivalent radiator system | 95 | System/boiler pressure installed on return pipe |

Circulation pump, radiator system (G1) (G2)

The circulation pump is fitted on the boiler's primary flow and must be connected electrically from the boiler; see chapter on Electrical installation.

Mixing valve DHW (65)

Install a mixing valve for the hot tap water in order to avoid the risk of scalding.

Safety valve DHW (93)

Fit the enclosed valve to the incoming cold water connection. Connect the waste pipe to the waste system directly to the floor gully or, if the distance is more than two metres, to a funnel. The waste pipe must slope towards the waste system, be installed frost-free and left open to the atmosphere/without pressure.

Non-return valve (48)

Fit the non-return valve to the incoming cold water connection.

Shut-off valve (94)

It is important to fit a shut-off valve (94) to both the primary and return flows.

Boiler safety valve (92)

The boiler's safety valve (2.5 bar) is fitted in the factory on the left side of the top. Connect the waste pipe to the waste system directly to the floor gully or, if the distance is more than two metres, to a funnel. The waste pipe must slope towards the waste system, be installed frost-free and left open to the atmosphere/without pressure.

Filling valve for radiator system (90)

Fit a filling valve between the cold water connection and the radiator return pipe, or between the cold water pipe and the expansion pipe. Observe the building regulations of the Swedish National Board of Housing, Building and Planning (Boverket) and the standard SS-EN 1717.

Manometer system pressure (95)

Fit the manometer on the expansion pipe or radiator return pipe.

Electric shut-off valve (47)

If the sub-mixing valve (radiator system 2) is to operate in the summertime while radiator system 1 is switched off, the system can be supplemented by an electric shut-off valve that closes the flow through the switching off of radiator pump (G1).

 NB: It is important to fit a shut-off valve (94) to both the primary and return flows.

 NB: The waste pipe must be fitted to the waste system.

Expansion vessel connection

The CTC EcoZenith i250 is best connected to a closed expansion vessel. The CTC EcoZenith i250 is designed to be fitted to an 18 l closed expansion vessel. The expansion vessel is either fitted in the area under the tank or on top of the product (see pictures). The expansion vessel with installation kit is available as an accessory.

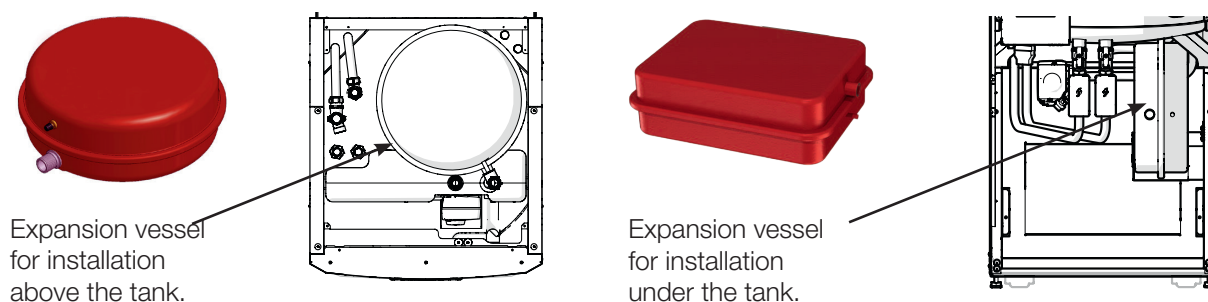

! NB: If the heat pump is not connected, the connections not being used must be capped off!

If you connect the product to an open system, the distance between the expansion vessel and the highest placed radiator must not be less than 2.5 metres in order to avoid introducing oxygen into the system.

Note that no hot water circulation may be connected as it affects the function of the CTC EcoZenith and the system. If the CTC EcoZenith i250 is connected to another heat source, e.g. an existing boiler, the installations must have separate expansion vessels.

Water taps

In some cases, unusual noises may be produced by the house's pipe system and the CTC EcoZenith i250 due to the jolts which occur when the flow is quickly interrupted. There is no fault with the product, but the noise may occur when older model outlets are used. More recent outlets are often fitted with a soft-closing mechanism. Alternatively, a shock arrestor can be fitted. Keeping the jolting to a minimum also helps avoid unnecessary wear and tear affecting the DHW system.

12.3 Connection to heat pump

The heat pump is connected to the top (CTC EcoZenith i250L, see figure below) or bottom (CTC EcoZenith i250H).

The charge pump for the heat pumps is factory-installed in the CTC EcoZenith i250L.

The CTC EcoZenith i250 L has pipes at the rear right edge for connection of the heat pump.

The CTC Eco Air's lower connection (5) is connected to the right connection (2) when viewed from the front, so that water is pumped out to the heat pump. The CTC EcoAir's upper connection (4) is thus connected to the left connection (1).

The CTC EcoZenith i250 H heat pump is connected directly to the supplied charge pump (3) located under the tank. The heat pump's lower connection (5) must be connected to the charge pump (3) so that water is pumped out to the heat pump. The heat pump's upper connection is connected to the right diverting valve (viewed from the front).

Draining: A drain valve must be fitted to the CTC EcoZenith's left connection (where the charge pump is mounted). It functions as drainage for both the boiler and the radiator system.

Pipe connection for CTC EcoZenith i250 L

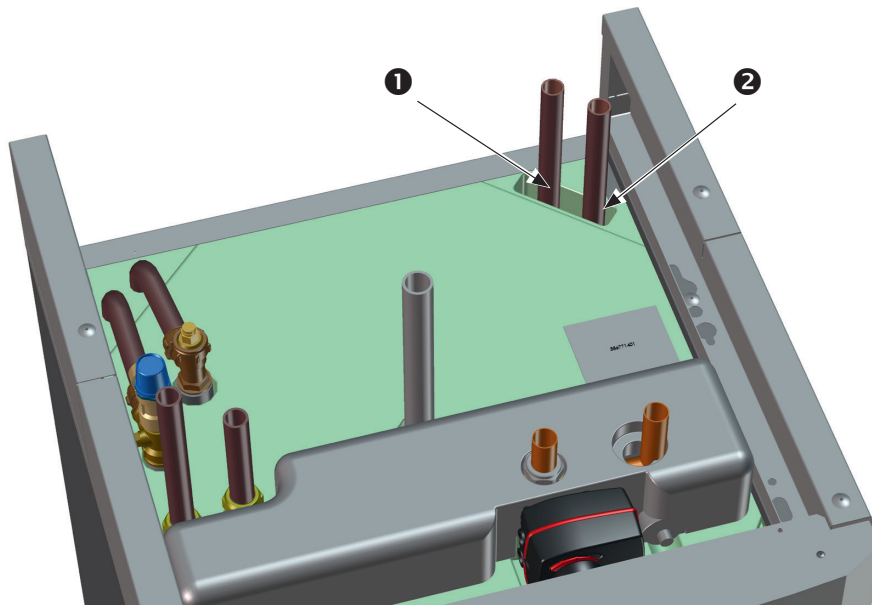

1. Incoming (heated water) from heat pump
2. Outgoing (cold water) to heat pump

Pipe connection for CTC EcoZenith i250H

(The picture shows the back of the product)

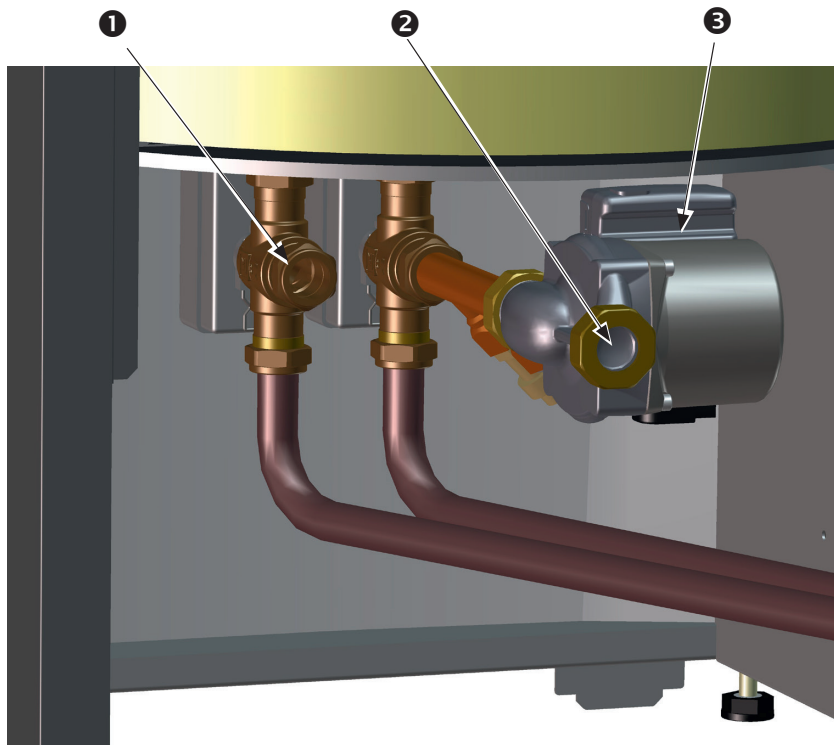

1. Incoming (heated water) from heat pump Ø22
2. Outgoing (cold water) to heat pump, union 3/4
3. Preassembled charge pump on CTC EcoZenith i250L installed on 250H (behind the diverting valves). The pump pumps water to the connected heat pump.

Pipe connection for CTC EcoAir 400

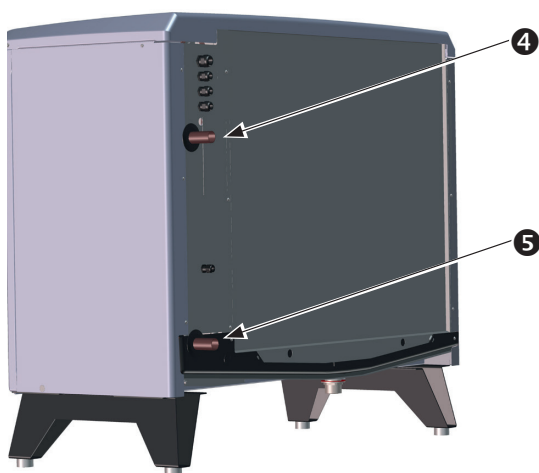

4. Outgoing (heated) water to boiler.
5. Incoming (cold) water from boiler.

Pipe connection for CTC EcoPart 400

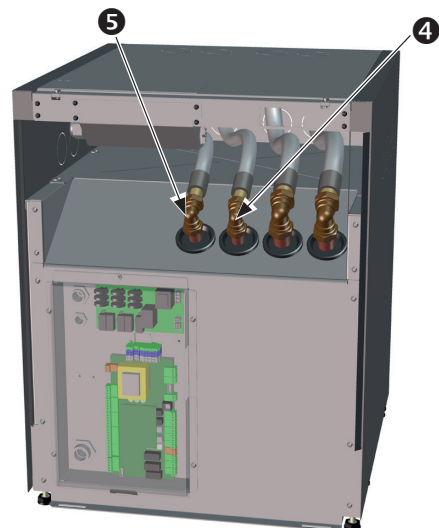

12.4 DHW system

You can connect a DHW circulation system. You can see this kind of connection in the figure below.

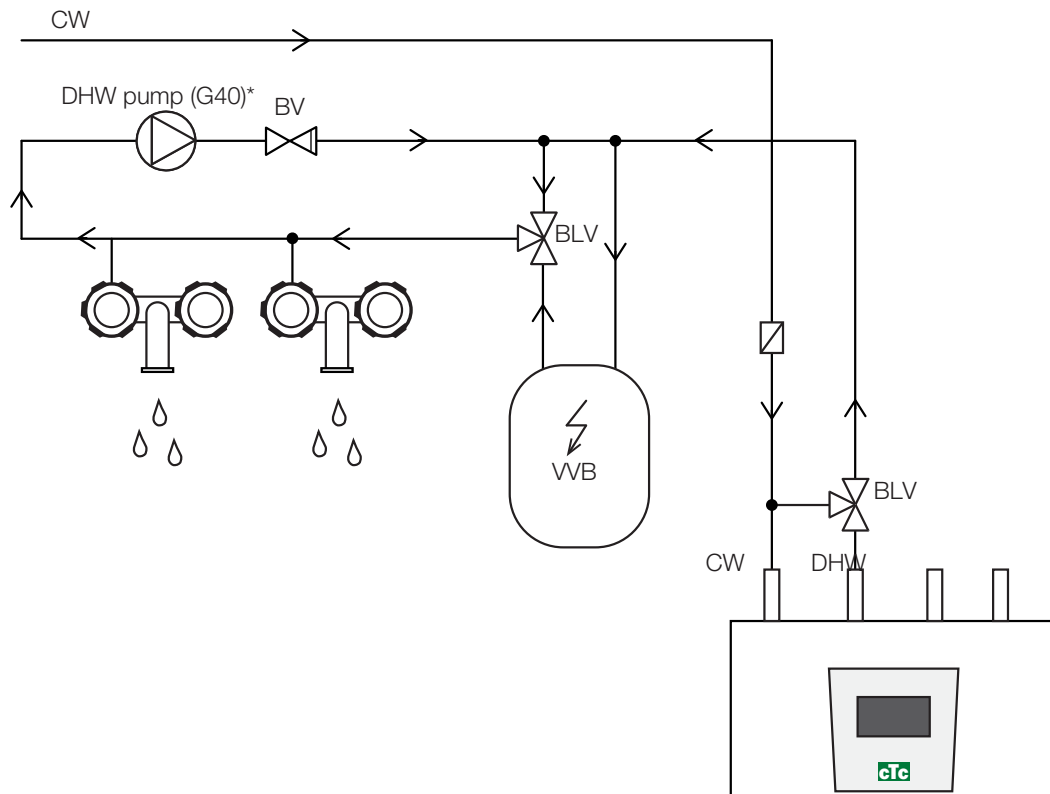

(*G40 Not controlled by the product. Use a separate control or constant voltage on the circulation pump.)

12.5 Schematic diagram cooling -Common Heating and Cooling

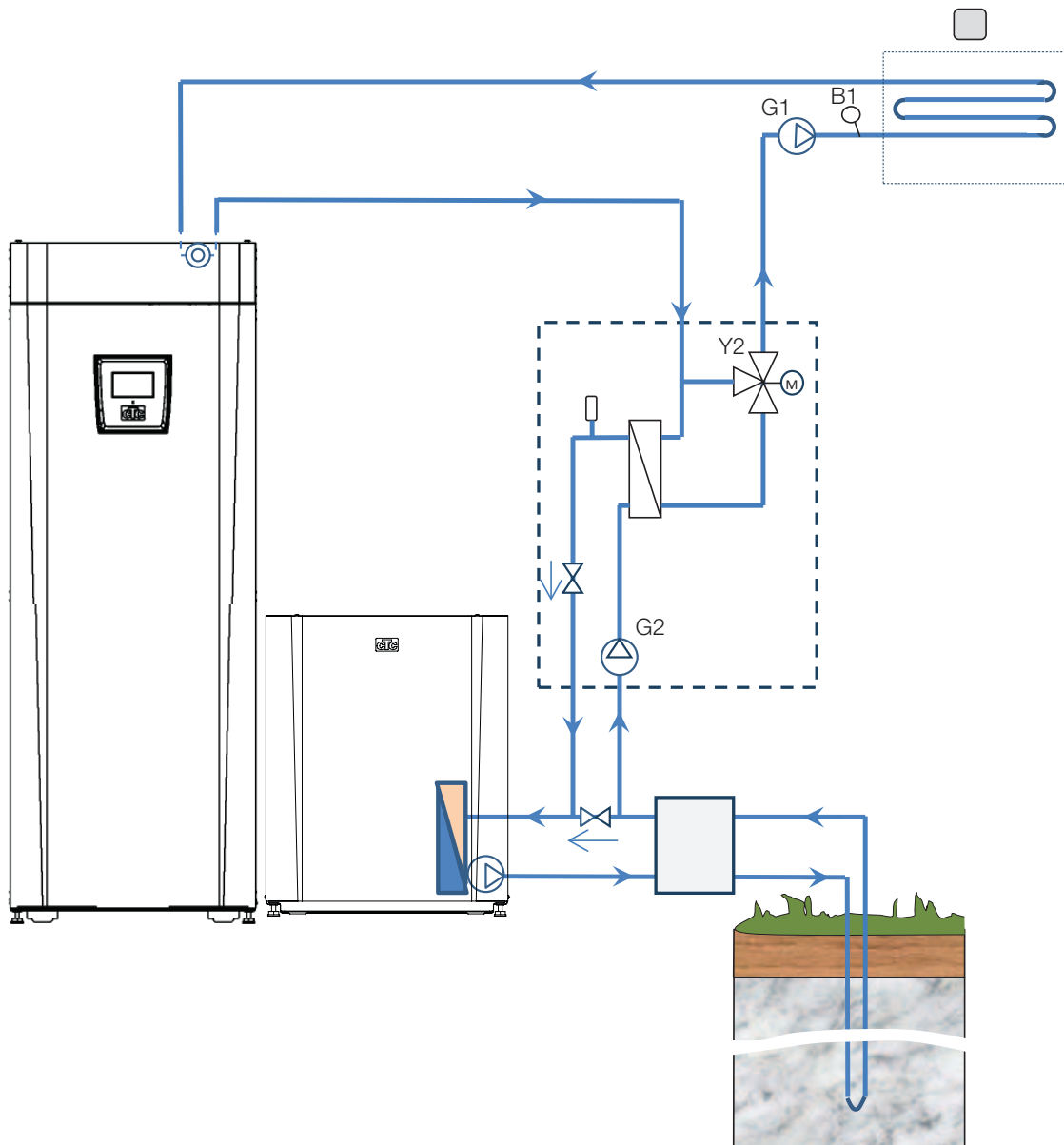

12.6 Schematic diagram cooling

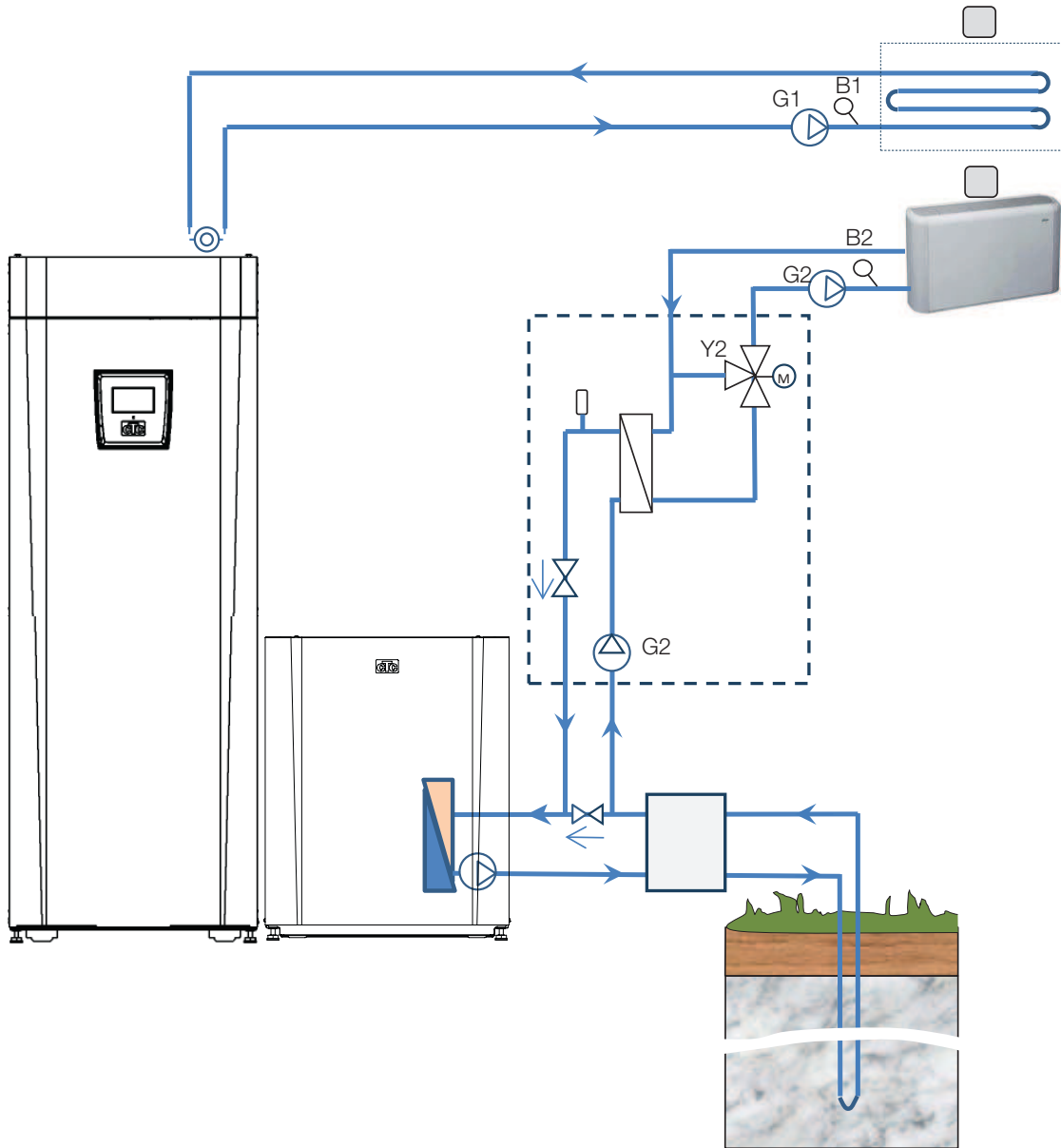

13. Energyflex

Energyflex is a collective term that describes CTC's unique opportunity for maximum flexibility and combining different heat sources in a simple way. The most common combination is a heat pump and electric boiler.

It is worth noting here that when installed the CTC EcoZenith i250 can serve as an electric boiler alone, but it can subsequently be augmented with:

CTC EcoPart Heat Pump (ground source)

CTC EcoAir Heat Pump (air to water)

Solar Energy

The CTC EcoHeat/EcoZenith now has integrated functionality for simple augmentation with

Solar Energy

Pool

Wood-Fired Heating

Regarding wood-fired heating:

The integrated "Differential thermostat function" control initiates the charge from, e.g., the existing wood-fired system or fireplace when the temperature is higher than it is in the CTC EcoHeat/EcoZenith i250

Bear in mind that it can also be a good idea to install an automatic charger that can protect the wood-fired system from condensation, etc

If the wood-fired system needs more water than the 223 l contained in the product, the system needs to be supplemented with an accumulator tank.

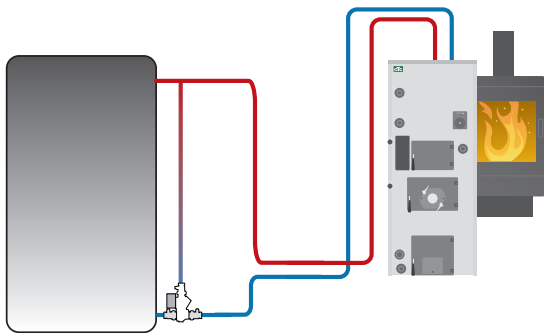

Example of wood-fired system with group of chargers

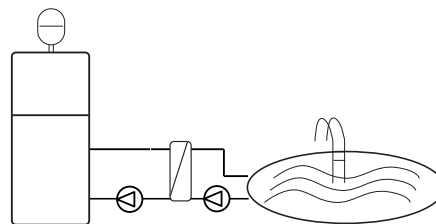

Energyflex can also be used to draw energy, e.g. to heat a swimming pool

■ Connecting external systems can seriously affect the EcoZenith's operation and performance and can therefore produce undesirable effects if the system is not installed correctly.

If you are unsure how to make the connection, contact CTC for suggestions on how to install the system.

Schematic diagram only The installer adds expansion vessels, safety valves, etc., and sizes the system.

Introduction Energyflex - EcoSol

The CTC EcoHeat and CTC EcoZenith i250 H/L have a water volume of 223 l with layered disc and solar output. Solar output (3/4) is a part of Energyflex.

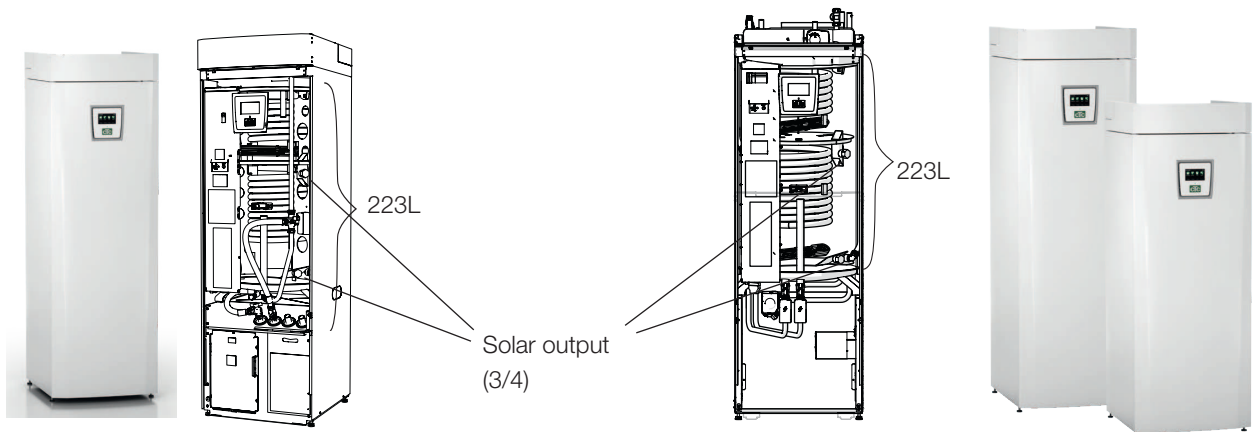

CTC Ecoheat 400
(223L with solar output and layered disc).

CTC EcoZenith i250 H/L
(223L with solar output and layered disc).

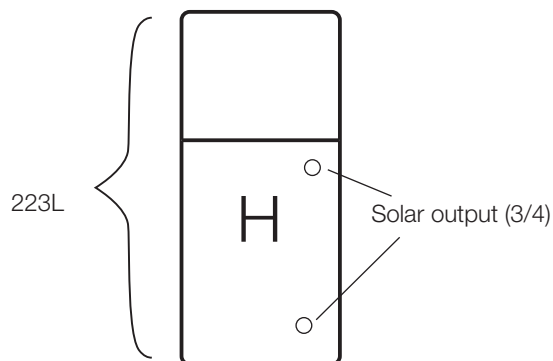

H. Symbol of tank volume in CTC EcoHeat 400 and CTC EcoZenith i250.

The tank in the CTC EcoHeat 400 and CTC EcoZenith i250 will be called the H-tank (main tank).

Energy can be collected through the solar outputs (solar panels, wood-fired boiler) or generated (swimming pool).

Available as accessories are pre-bent pipes with couplings and insulation to facilitate installation.

Also available as accessories are CTC Solar Control/Expansion Card

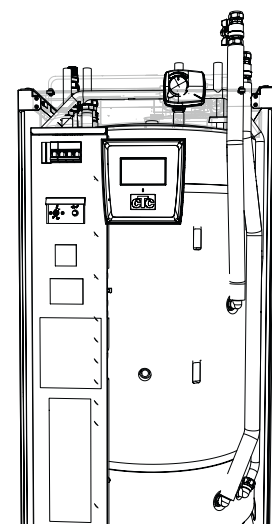

Accessory pipe kit Energyflex kit 400 fitted to H-tank

System options, Energyflex

The flexibility in the CTC EcoHeat and CTC EcoZenith i250 is optimised because the products contain functionality for five basic systems. These are:

Solar "system 1"

Solar "system 2"

Solar "system 3"

Diff thermostat function

Pool

Solar also offers the facility to recharge the drill hole or collect energy for an extra tank, with or without a solar coil.

*The differential thermostat function can be connected to an existing PCB in the CTC EcoHeat 400/CTC EcoZenith i250, while Solar systems 1, 2, 3 and Pool require the product to be supplemented with the CTC Solar Control/Expansion Card accessory.

Explanations of system options

Solar system 1

Charge from solar panels only to the H-tank (H) in the CTC EcoHeat 400 or CTC EcoZenith i250

Solar system 2

Charge from solar panels only to the EcoTank buffer tank + CTC EcoHeat 400/CTC EcoZenith i250.

Solar system 3

Charge from solar panels either to X-Volume or CTC EcoHeat 400/CTC EcoZenith i250.

Using a diverting valve, the charge is prioritised either to the H-tank in the EcoHeat/EcoZenith i250 or to the external X-volume

Diff thermostat function

The differential thermostat function is used if you want to charge your EcoHeat/EcoZenith from an existing wood-fired boiler, a water-jacketed stove or another cheap heat source.

The function compares the temperature in the EcoHeat/EcoZenith and the external heat source. Charging starts when it is warmer in the external heat source.

NB: For certain heat sources, e.g. solid fuel boilers, automatic chargers are recommended, among other things to counteract condensation in the fire box.

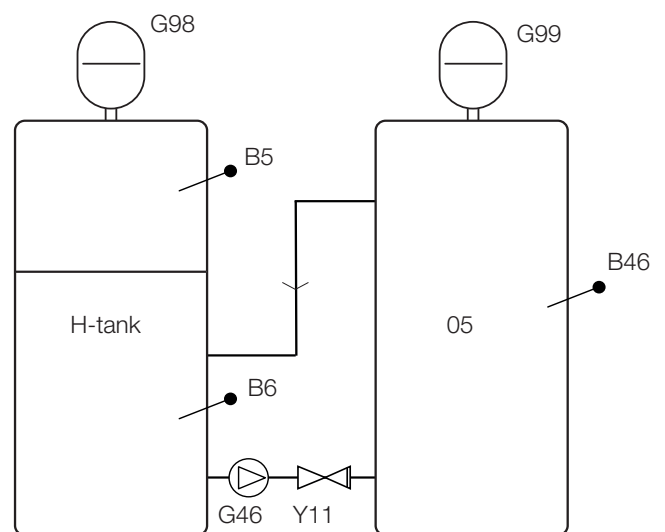

Schematic diagram for differential thermostat function

Schematic diagram only The installer adds expansion vessels, safety valves, etc., and sizes the system.

14. Electrical installation

Installation and connection in the CTC EcoZenith i250 must be undertaken by an authorised electrician. All wiring must be installed according to applicable regulations. The boiler is internally connected by the factory and set for a 5.5 + 6.0 kW power output. Depending on the country in which CTC EcoZenith i250 is to be installed, it is available with a 400 V or 230 V electrical connection.

Supply

Safety switch

The installation should be preceded by an omnipolar safety switch according to overvoltage category III, which ensures disconnection from all electric power sources.

Circulation pump connection for radiator system (G1)

The radiator pump is connected electrically to the terminal board. Electrical data: 230V 1N~. Internal fuse 10 A.

Max. thermostat

If the heat pump has been stored in an extremely cold place, the max. thermostat may have been triggered. You reset it by pressing in the button on the electrical switchboard behind the front panel.

Always check on installation that the max. thermostat has not tripped.

Symbol for max. thermostat:



14.1 Electrical installation 400 V 3N~

The CTC EcoZenith i250 must be connected to 400 V 3N~ 50 Hz and protective earth.

The power supply cable is connected at (1). Length 180 cm. The minimum group fuse size is specified in "Technical data".

14.2 Electrical installation 230V 1N~

The CTC EcoZenith i250 must be connected to 230V 1N~ 50 Hz and protective earth.

The power supply cable is connected at (1). Length 180 cm. The minimum group fuse size is specified in "Technical data".

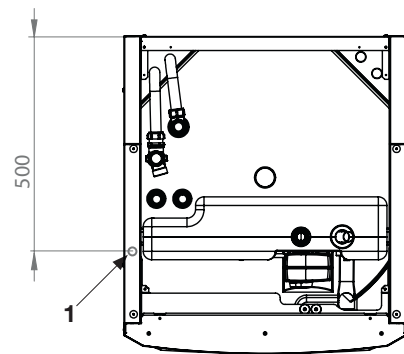

14.3 Positioning of electrical components

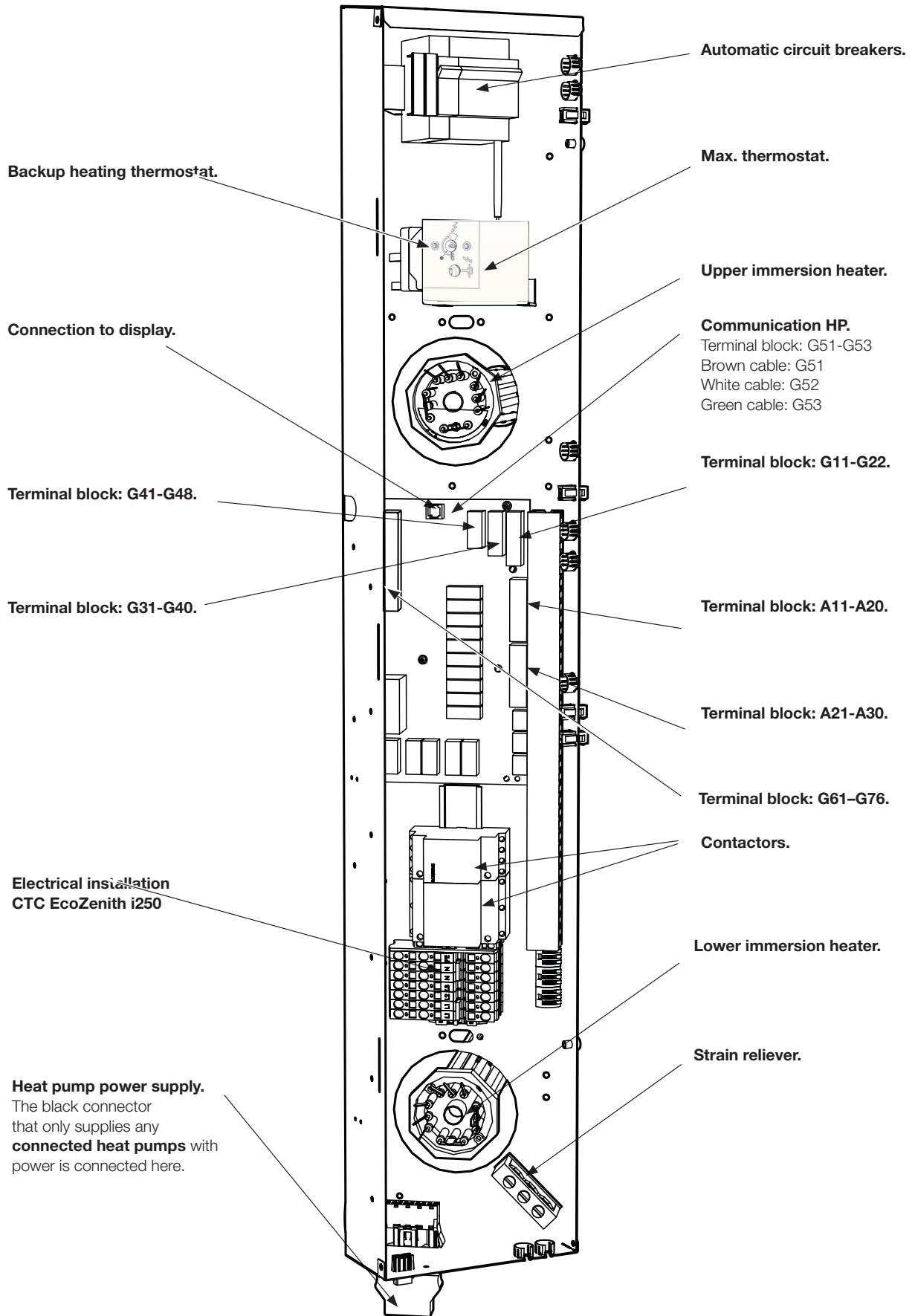

14.4 Electrical connection to heat pump

General

The CTC EcoAir 406-410, CTC EcoAir 510M or CTC EcoPart 406-412 heat pumps receive their power supply from the CTC EcoZenith i250 via a separate connector.

Charge pump

The factory-installed charge pump for heat pumps is connected internally in the CTC EcoZenith i250 L.

The charge pump is connected to CTC EcoZenith i250 H in the pre-assembled connector (Molex and PWM) located under the electrical cabinet.

When working on the heat pump

Before starting any work on the heat pump the safety switch installed in front of the CTC EcoZenith i250 should be activated.

14.4.1 Communication

The CTC EcoAir 406-410, 500M or CTC EcoPart 406-412 heat pumps are controlled from the CTC EcoZenith i250. Other makes of heat pump cannot be controlled from the CTC EcoZenith. Communication between the products takes place via an LIYCY (TP) communication cable, which is a 4-conductor shielded cable, where the communication-bearing conductors are of twisted pair type. The connection is made in the communication port on the PCB and in the heat pump in accordance with its instruction manual.

G51 = Brown cable, G52 = white cable, G53 = green cable.



The detailed illustration from the wiring diagram shows the communication connection.

CTC EcoAir

Grey communication connector.

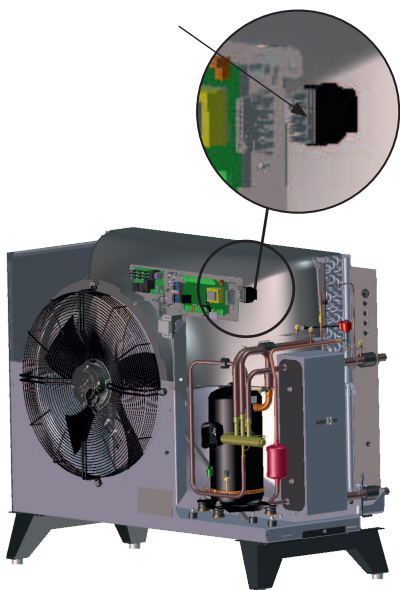

CTC EcoPart

Communication terminal block.

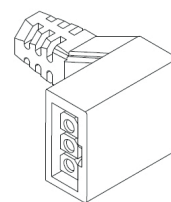
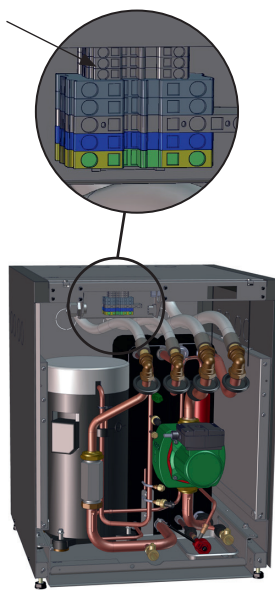

Charge pump Molex switch

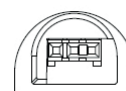

Charge pump PWM switch

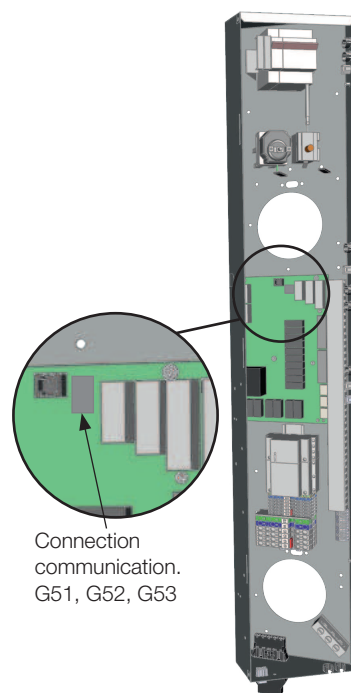

Connection communication. G51, G52, G53

CTC EcoZenith connection box

14.4.2 Heat pump power supply 400 V 3N~

The heat pump must be supplied with power from CTC EcoZenith i250 using the provided black connector located in the bottom of the electrical cabinet.

(NB: no supply to CTC EcoAir 614, 620)

The minimum group fuse size is specified in "Technical data".

Recommended cable 400 V 3N~, approved for outdoor use, UV resistant 110 5G 2.5 black.

The cable is connected between the products in accordance with the heat pump's instruction manual.

14.4.3 Heat pump power supply 230V 1N~

The heat pump must be supplied with power from CTC EcoZenith i250 using the provided black connector located in the bottom of the electrical cabinet.

The minimum group fuse size is specified in "Technical data".

Recommended cable 230 V 1N~ Ölflex 110 3G 4 black.

Recommended cable 230 V 1N~, approved for outdoor use, UV resistant 110 3G 4 black.

The cable is connected between the products in accordance with the heat pump's instruction manual.

14.4.4 Connecting the heat pump connector

- We recommend pulling the cable through the cable clip before you connect the wires. The cable clip can also be fitted afterwards.
(See figure 1)
 - a. Outer sleeve scaled to 55 mm
 - b. Wires scaled to 9 mm
 - c. Advanced protective earth wires scaled to 7 mm
- Open the terminal block by pushing a screwdriver (blade width 2.5mm) into the block. Connect the stripped wires in the specified positions. Check that only the stripped parts are clamped to the terminals, **NO INSULATION!**

(see figures 2 and 3)

- Fix the cable clip to the connector. The word TOP should be visible on the terminal and the cable clip
(see figure 4)

Push the cable clip onto the connector. Then tighten the screw to obtain the desired tension.

see figure 5)

Connector for supplying power to heat pumps!



Figure 1

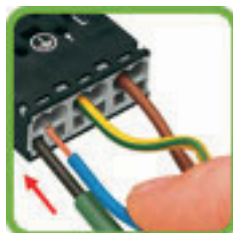

Figure 2



Figure 3



Figure 4



Figure 5

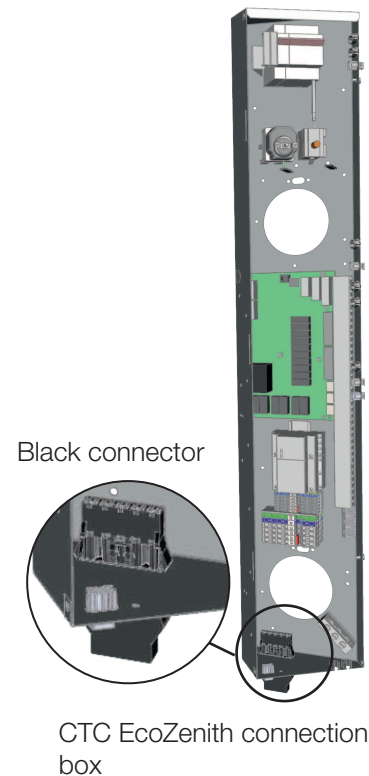

Black connector

CTC EcoZenith connection box

14.5 Extra low voltage protection

The following outputs and inputs have extra low voltage protection: current sensor, outdoor sensor, room sensor, primary flow sensor, return sensor, NR/SO, temperature sensor, level switch and PWM signals.

Connection of outdoor sensor (B15)

The sensor should be set up on the house's northwest or north side, so that it is not exposed to morning and evening sun. If there is a risk of the sensor being affected by the sun's rays, it must be protected by a screen.

Place the sensor at around 2/3 of the height of the facade near a corner, but not under a roof projection or other form of wind protection. Do not place it either above ventilation ducts, doors or windows where the sensor may be affected by factors other than the actual outdoor temperature.

Connection of room sensor (B11) (B12)

The room sensor is fitted at a central point in the house, in the most open position possible, ideally in a hall between several rooms. This is the best position for the sensor to record an average temperature for the house.

Feed a three-conductor cable (minimum 0.5 mm²) between the heat pump and room sensor. Then attach the room sensor securely in a position at roughly two thirds of the way up the wall. Connect the cable to the room sensor and CTC EcoZenith.

! Do not attach the sensor cable permanently until you have tested where the best location is.

Connection of primary flow sensor (B1, B2) /return sensor (B7)

Fit the primary flow sensor to the primary flow pipe, ideally after the circulation pump. Fit the return sensor to the return pipe.

The sensing part is towards the end of the sensor (see sketch).

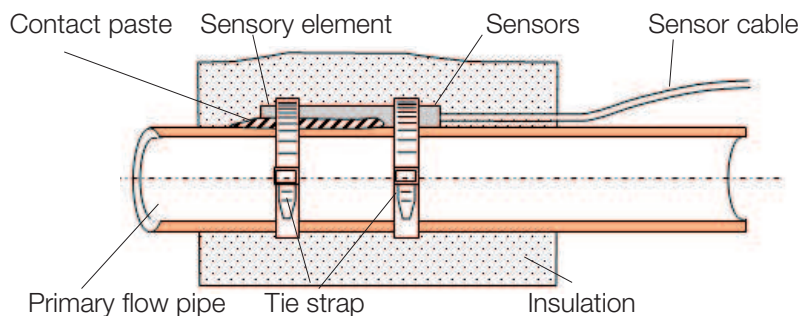

- Attach the sensor using the tie strap provided.
- Ensure that the sensor makes good contact with the pipe. Apply contact paste to the front part of the sensor between the sensor and the pipe if good contact is otherwise difficult to obtain.
- **Important!** Insulate the sensor using pipe insulation.
- Connect the cables to the CTC EcoZenith's terminal board.

14.5.1 Current sensor connection

The three current sensors, one for each phase, are fitted on the fuse panel in the following manner.

Each phase from the electricity distribution board supplying the EcoHeat is channelled through a current sensor before termination at the relevant terminal. This allows the phase current to be sensed all the time and compared with the value set for the heat pump's load switch. If the current is higher, the control unit drops to a lower heat output on the immersion heater. If this is insufficient, the heat pump is also limited. When the power drops back to the set value, the heat pump and immersion heater are reconnected.

This means that the current sensors, along with the electronics, prevent more power being supplied than the main fuses can tolerate.

The current sensors' holes for cables are 11 mm in diameter.

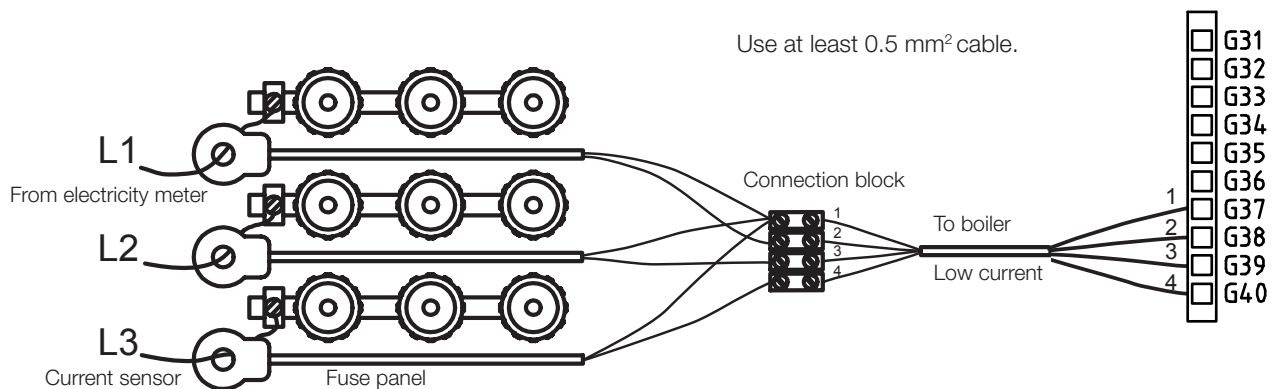

14.5.2 Terminal boards

There are terminal boards for sensors, radiator pumps, etc. behind the panel.

! Open the spring block first using a screwdriver before the cable is inserted. Otherwise, there is a risk of poor contact. Also make sure that the conductor is sufficiently stripped.

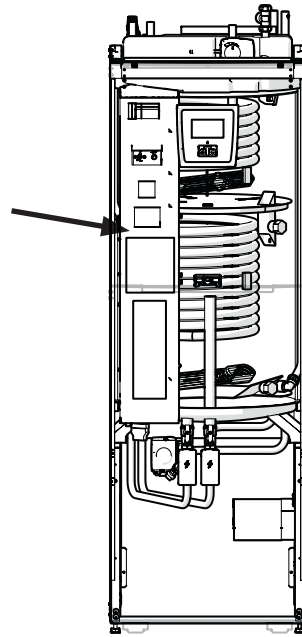
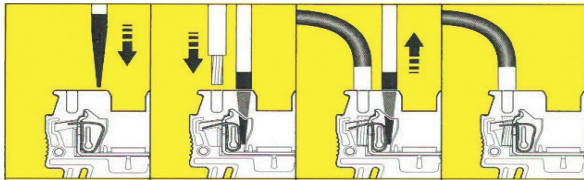

14.6 Settings made by the installation electrician.

The following settings shall be made by the installation electrician after installation:

- Select main fuse size
- Select the power limitation for the immersion heater.
- Check room sensor connection
- Check that the sensors connected indicate reasonable values.

Carry out the following checks:

Main fuse and effect limitation settings

See the chapter on First start.

Check room sensor connection

- Go to the menu: Installer/Service/Function test/Radiator system.
- Go down and select the option LED room sensor and press OK.
- Select On using the + button and press OK.
Check that the room sensor LED lights up. If not, check the cables and connection.
- Select Off using the - button and press OK. If the OK LED goes off, the check is complete.
- Return to start menu by pressing the Home button.

Check connected sensors

If any sensor is incorrectly connected, a message will appear on the display, e.g. "Alarm sensor out". If several sensors are incorrectly connected, the different alarms are displayed on different rows.

If no alarm is displayed, the sensors are connected correctly.

The current sensor connection has no alarm, but the current value can be read in the Operation data menu. Note that the tolerance/accuracy is very low with small current values.

14.7 Installing a backup power supply

The DIP switch on the PCB is used to set the backup power supply. The DIP switch is marked "RESERV" (BACKUP).

When the switch is set "ON", the step is actively operating in backup heating mode.

400V 3N~

Relay	EL3A	EL2B	EL2A	EL1B	EL1A
Current	10 A	10 A	2.6 A	10 A	1.3 A
Power	1.2 kW	2.3 kW	0.6 kW	2.3 kW	0.3 kW

230V 1N~

Relay	-	EL2B	EL2B	EL1B	EL1A
Ström	-	8,7 A	8,7 A	8,7 A	13 A
Power	-	2,0 kW	2,0 kW	2,0 kW	3,0 kW

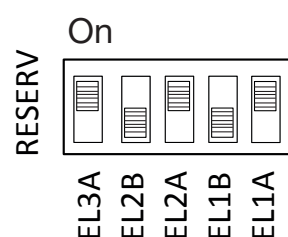

Example for $1.2+0.6+0.3 = 2.1$ kW 3~.

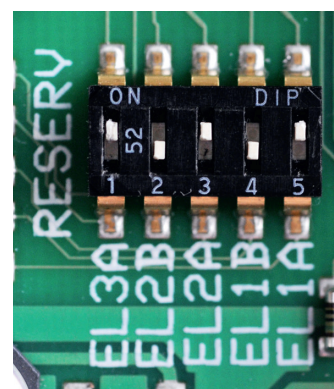

14.8 Switching to 18 kW electric heater power.

CTC EcoZenith i250 3x400 V can be reconnected to a 18 kW immersion heater.

NB: Installation must be carried out by a qualified electrician.

Connecting

1. Begin by disconnecting the power to the product.
2. Free the three black wires with insulation sleeves from the cabling.

Warning Begin by disconnecting the power to the product. Installation must be carried out by a qualified electrician.

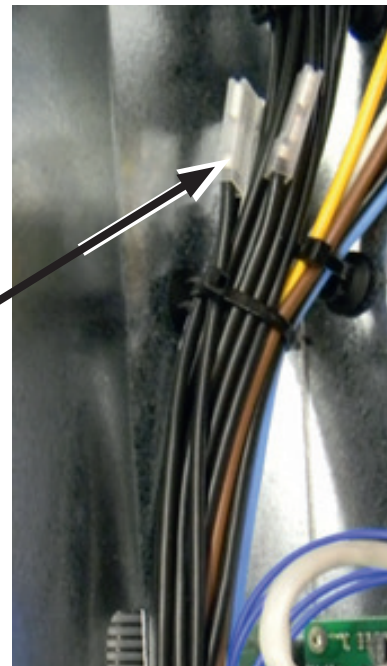
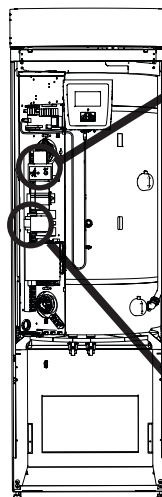

3. Undo the smallest switch (K2 on the electrical diagram) by pulling the yellow fastening backwards.

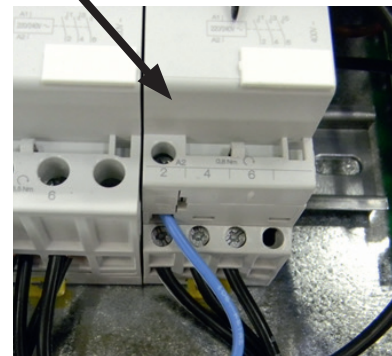

4. The black wires should have a designation stating the cable number and connection position. For example, 46 K2:1, where the 1 stands for screw joint position 1.

Begin by loosening the screw joint at position 1 and freeing the brown wire. Mount the brown and respective black wires in the same screw joint.

Repeat for screw joints on positions 3 and 5.

Tighten screw joints 1 to 5, inclusive.

Remount the switch on the DIN rail and lock using the yellow catch.

Then check that the switch is firmly in position on the DIN rail.



5. Mount the black wires in the free spaces on the electric heater.

NB: Only for angled flat pins with black end cable sleeves.

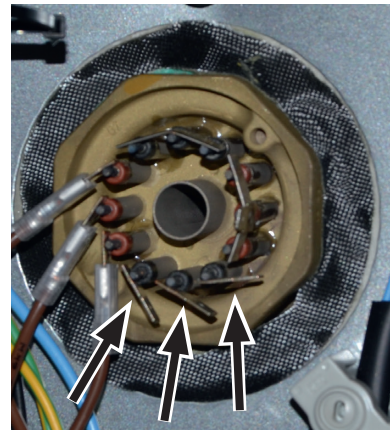

14.9 Connection of pump (G46) to Diff. therm. func.

230 V 1N~

The Circulation pump (G46) is connected at the following terminal blocks:

Relay card in the CTC EcoZenith i250 (see wiring diagram).

Note the cable colours!

Phase:	brown	Terminal block A:11(CTC EcoZenith i250)
Zero:	blue	
Earth:	yellow/green	

Check the function by test running the pump in menu "Installer/Service/Function test" in the control system.

14.10 Connection of sensor (B46) to Diff. therm. func.

Ntc22k

Sensor B46 is connected to terminal block G65,G66

14.11 Wiring diagram 3x400 V

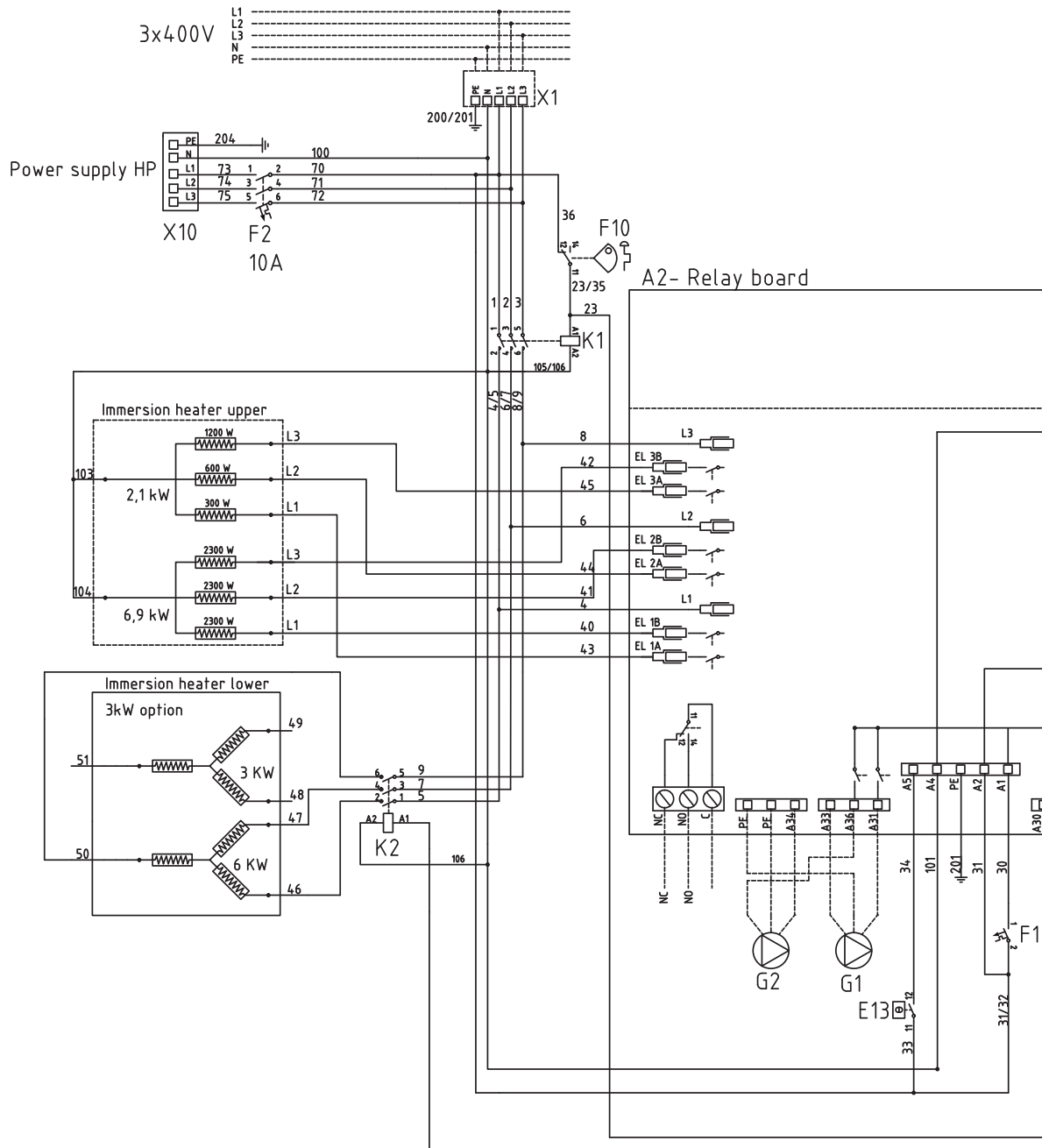

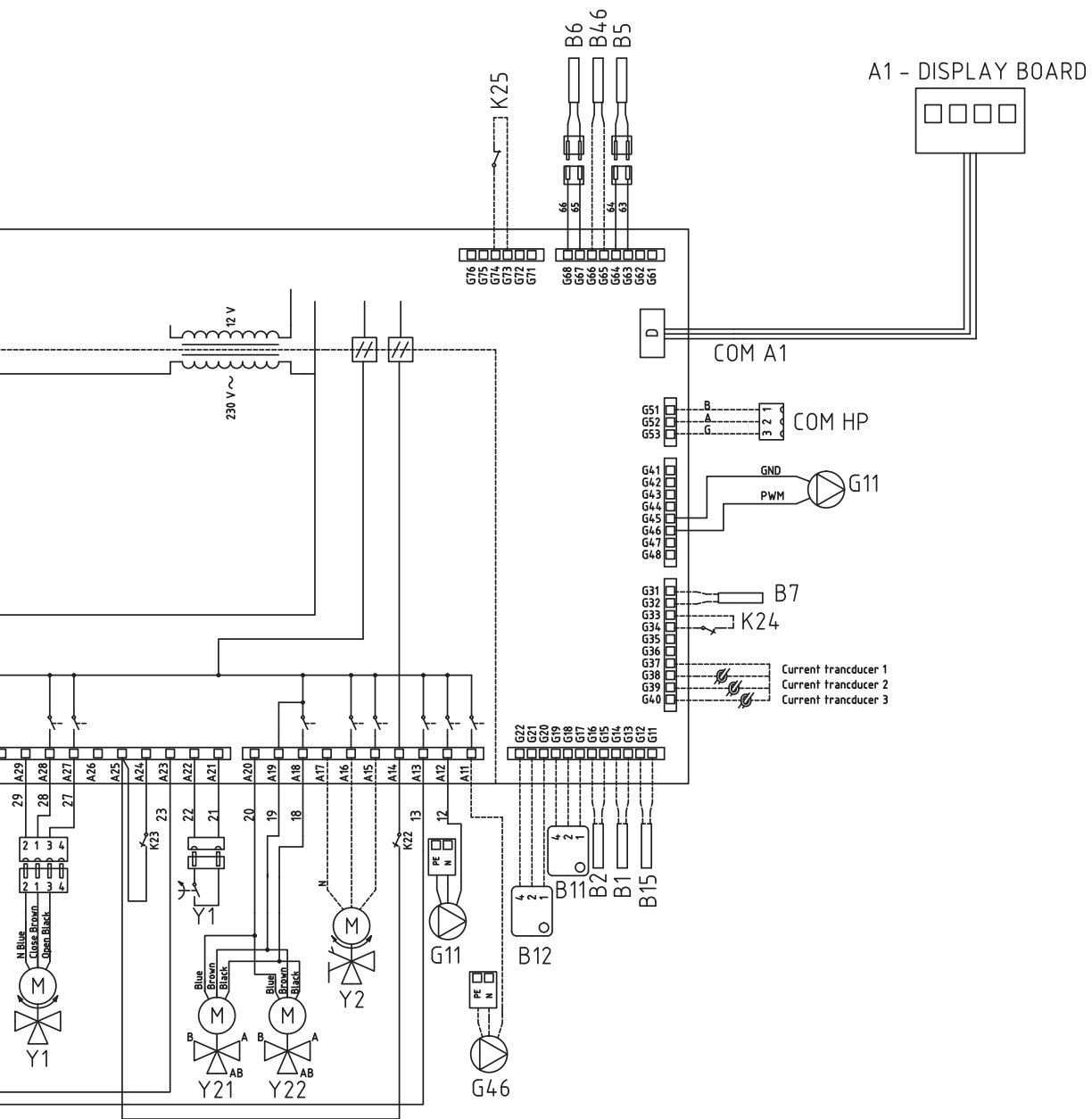

14.12 Wiring diagram 1x230 V

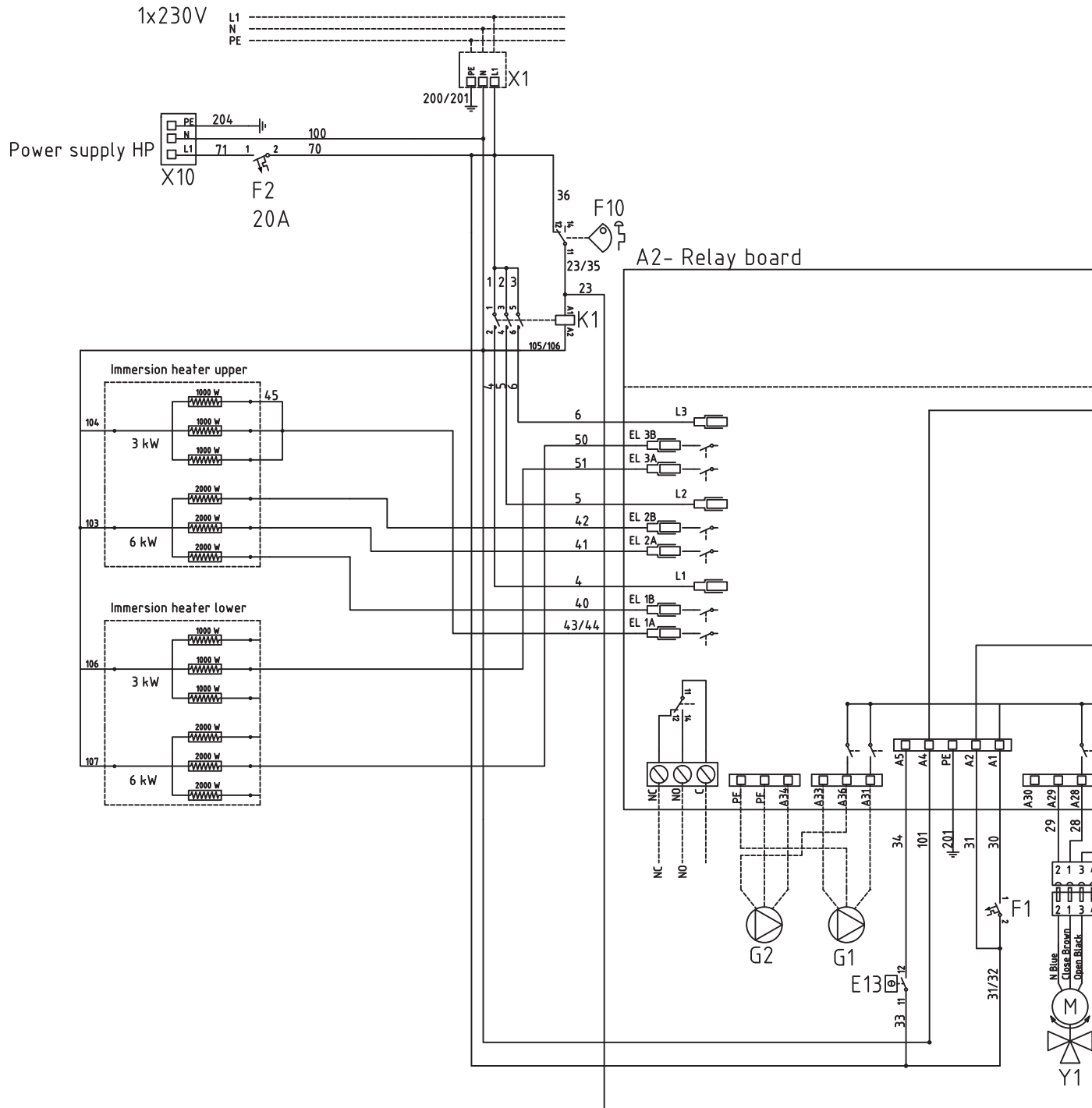

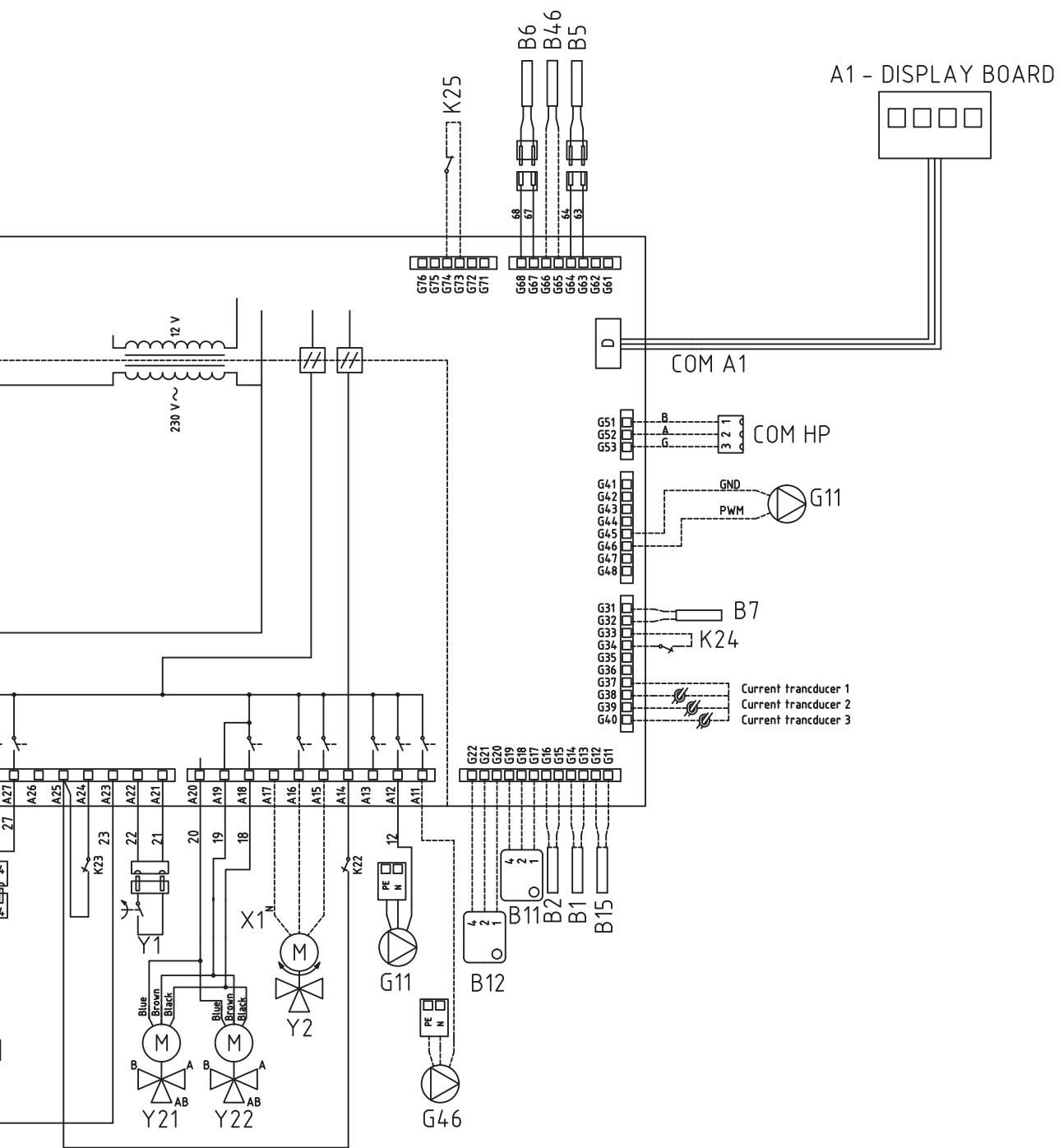

14.13 Component list, wiring diagram

No.	Component.	
A1	Display	
A2	Relay/main card	
A3	CTC Solar controls/Expansion card	
A4	PCB white softstarter, motorprotection and contactorfunction	
A5	Heatpump control board	
B1	Primary flow sensor 1	NTC 22
B2	Primary flow sensor 2	NTC 22
B5	Upper tank sensor	NTC 22
B6	Lower tank sensor	NTC 22
B7	Return sensor	NTC 22
B11	Room sensor 1	NTC 22
B12	Room sensor 2	NTC 22
B15	Outdoor sensor NTC 150	NTC 150
B46	Sensor external tank – Differential thermostat function.	NTC 22
COM HP	Communication heat pump	G51 = Brown cable, G52 = white cable, G53 = green cable.
E13	Backup heating thermostat E13	
F1	Automatic circuit breaker 10 A	
F2	Automatic circuit breaker HP 10 A	
F10	Max. thermostat	
G1	Radiator pump 1	
G2	Radiator pump 2	
G11	Charge pump	
G40	DHW pump (Not controlled by the product, separate control/constant voltage)	
G46	Charge pump external tank – Differential thermostat function	
H	H-tank	Main tank (EcoHeat/EcoZenith i250)
K1	Contactactor 1	
K2	Contactactor 2	
K22	Flexible remote control/ Smart Grid	
K23	Flexible remote control/ Smart Grid	
K24	Flexible remote control/ Smart Grid	
K25	Flexible remote control/ Smart Grid	
X1	Terminal block, incoming supply	
X10	Terminal block, HP supply	Black connector
Y1	Mixing valve 1	
Y2	Mixing valve 2	
Y11	Non return valve	
Y21	Diverting valve DHW	
Y22	Diverting valve DHW	
Y98	Expansion tank	
Y99	Expansion tank	

14.14 Resistances for sensors

NTC 22 k Ω

Temperature °C	NTC 22 k Resistance Ω
130	800
125	906
120	1027
115	1167
110	1330
105	1522
100	1746
95	2010
90	2320
85	2690
80	3130
75	3650
70	4280
65	5045
60	5960
55	7080
50	8450
45	10130
40	12200
35	14770
30	18000
25	22000
20	27100
15	33540
10	41800
5	52400
0	66200
-5	84750
-10	108000
-15	139000
-20	181000
-25	238000

Outdoor sensor NTC 150

Temperature °C	Outdoor sensor Resistance Ω
70	32
65	37
60	43
55	51
50	60
45	72
40	85
35	102
30	123
25	150
20	182
15	224
10	276
5	342
0	428
-5	538
-10	681
-15	868
-20	1115
-25	1443
-30	1883
-35	2478
-40	3289

15. Connection of CTC EcoAir 500M heat pump

The CTC EcoAir 500M is a modulating heat pump that is fully designed to work with the CTC EcoZenith i250L.

The CTC EcoAir 500 consists of the models:

- CTC EcoAir 510 3x400V
- CTC EcoAir 520 3x400V
- CTC EcoAir 510 1x230V

Default rules for control

- The heat pump strives to deliver the correct temperature to the primary flow water. I.e. the reference value for the upper tank or lower tank. The setpoint for the upper tank or lower tank. If there is insufficient power the compressor speed increases. When the temperature approaches the setpoint the compressor speed reduces.

Unique to CTC EcoAir 520 M

The following applies when installing the CTC EcoAir 520M with the CTC EcoZenith i250 H/L:

- Powered separately. The products are switched on separately. Control cabling only between the products.
- In the event of high pressure drops, due to long pipe installation etc., the circulating pump (G11) can be replaced with CTC item no. 586988301 (15-75 130) in order to manage the flow requirements.

! CTC EcoZenith i250 must have software version 20141219 or later.

! CTC EcoAir 520M Powered separately.

The CTC EcoAir 500M is set at the factory to automatically vary (modulate) the compressor speed between 20 and 90 rps in cold weather and to vary it between 20 and 50 rps in warm weather as shown in the adjoining diagram.

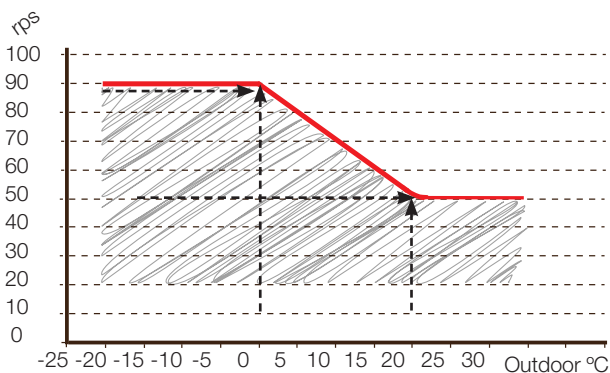

The CTC EcoZenith i250 is supplied with suitable factory settings for the CTC EcoAir 500M. Enertech AB recommend these for optimal operating economy.

15.1 Menu functions unique to the CTC EcoAir 500M

The following menu functions are unique to heat pumps that use inverter technology. (CTC EcoAir 500M)

15.1.1 Operation data heat pump



Compressor **On/Off/65 rps**

This shows whether or not the heat pump is operating as well as showing the compressor speed (rps).

The compressor speed is automatically tailored to the energy requirement, up to the maximum permitted speed as determined by the outdoor temperature.

Charge pump **On/Off/47%**

Display of the charge pump's operational status and speed as a percentage.

Fan **On/Off**

Shows whether the fan is operating or not.

HP in/out °C

Shows the heat pump's return and primary flow temperatures.

Current L1

Shows the current across the compressor (phase L1).

Heat pump	
Compressor	On 65 rps
Charge pump	On 47%
Fan	On
HP in/out °C	35.5 / 42.3
Current L1	4.0

The CTC EcoZenith i250 is supplied with suitable factory settings for the CTC EcoAir 500M. Enertech AB recommend these for optimal operating economy.

15.1.2 Heat pump Settings



Compressor Permitted/Blocked

The product is supplied with a blocked compressor. When the compressor is blocked, the product operates like an electric boiler. All other functions are intact.

Permitted means that the compressor is allowed to operate.

Stop at outdoor°C -22 (-22 – 0)

This menu relates to settings for the outdoor temperature at which the compressor is no longer permitted to operate. When the heat pump has stopped a start signal will only be given if the outdoor temperature is at least 2 °C warmer than the set value. The lowest outdoor temperature required for start is -18 °C.

Tariff HP No (No/Yes)

Find out more in section entitled “Define/Remote control”.

Compressor speed

Limit cold temp. (T2°C) 0

Temperature limit for winter power. When the outdoor temperature is this or lower, the compressor speed is adjusted up to speed R2.

Limit warm temp. (T1°C) 20

Temperature limit for summer power. When the outdoor temperature is this or higher, the compressor speed is adjusted up to speed R1. The heat pump starts and stops at the actual value and setpoint value.

Max. rps warm temp. (R1 rps) 50

Maximum compressor power in warm weather. Sets the maximum speed of the compressor at outdoor temperature T1

Max. rps (R2 rps) 90

Compressor power in cold weather. Sets the maximum speed of the compressor at outdoor temperature T2

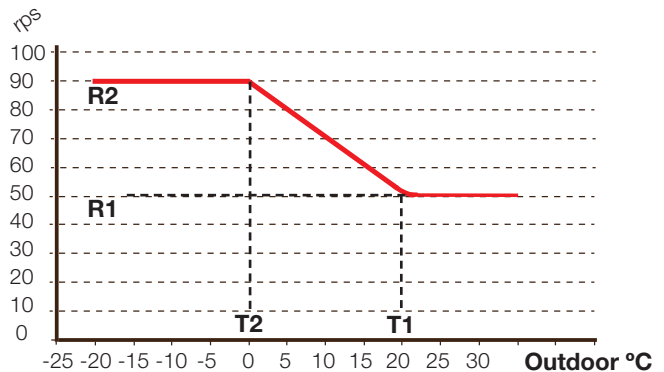
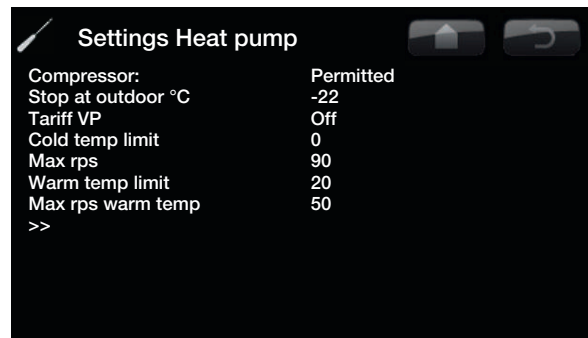

The CTC EcoZenith i250 is supplied with suitable factory settings for the CTC EcoAir 500M. Enertech AB recommend these for optimal operating economy.

15.1.3 Heat pump Settings continued

Max. rps on noise reduction **50 (50-100*)**

Max. rps on noise limitation. The compressor’s maximum speed when noise limitation is active.

NB: You should note that the maximum output of the heat pump will fall and the need to add heat may increase.

Timer Silent mode

This menu shows scheduled weekday periods when silent mode (noise reduction) should be activated. This schedule is repeated every week.

Max. rps on noise reduction 2 **50 (50-100*)**

Here you can set an additional noise reduction scheme for max rps.

Timer Silent mode 2

Here you can set an additional scheduled noise reduction scheme.

If two noise reduction schemes are active at the same time, the schedule with the lowest set rps value applies.

* depending on the model of heat pump

Charge pump **50 (In progress, 25,100)**

Charge pump speed in %.

The speed is calculated using the “Auto setting charge pump” function.

The speed can also be programmed manually. If the speed is selected manually, this value is displayed in red.

The value is also displayed in red on installation as “Auto setting charge pump” has not been run.

If a value of 100 is reached and displayed in red there is insufficient flow in the heat pump.

If a value of 25 is reached and displayed in red the flow in the heat pump is higher than optimal.

Auto adj. charge pump

This function starts the calculation of the optimal charge pump speed.

The function is activated by marking the “Auto setting charge pump” line and pressing “OK”. While calculation is in progress, “In progress” is displayed below the “Charge pump” line. Once calculation is complete the new value is placed in the “Charge pump” line, e.g. 72%

The calculation takes approx. 5 minutes. Do not touch the screen while “In progress” is displayed.

Different operating modes and seasons may produce differing results.

Any calculation should therefore be repeated after 4 weeks.

Smart block HP **No (No/Yes)**

This is used when a dual tariff is used with lower energy costs at set hours of the day. Find out more in section entitled Define/Remote control/Smart Grid

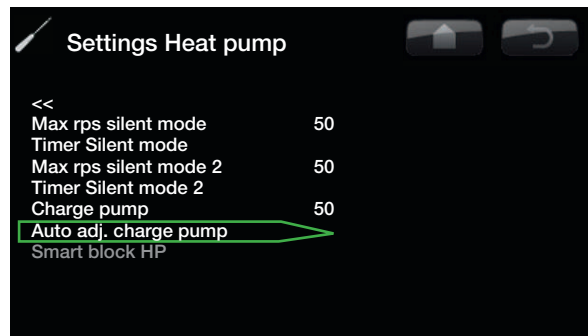

The CTC EcoZenith i250 is supplied with suitable factory settings for the CTC EcoAir 500M. Enertech AB recommend these for optimal operating economy.

15.1.4 Set Schedule Noise reduction

Noise reduction On/Off

Shows whether noise reduction is active (ON) or not (OFF)



Factory setting for noise reduction.

Noise reduction has NOT been activated (OFF)

The example shows that noise reduction is on:

From Monday 22:00 until Tuesday 06:00

“Active” means that the noise is currently being limited; if factory settings are used this means that the compressor speed may not exceed 50 rps.



e.g. where Noise reduction has been activated (On) and noise reduction is currently in progress (On – Active)

The CTC EcoZenith i250 is supplied with suitable factory settings for the CTC EcoAir 500M.
Enertech AB recommend these for optimal operating economy.

16. First start

When the CTC EcoZenith i250 is delivered, the heat pump is blocked to avoid it being started unintentionally. CTC EcoZenith i250 can be installed and started before the bedrock/ground source or air/water heat pump is put into operation.

The CTC EcoZenith i250 can also be started without a room sensor being fitted as the curve which has been set then regulates the heating. Deselect the room sensor in the Settings menu. The sensor can however always be fitted for the alarm LED function.

Before first start

1. Check that the CTC EcoZenith i250 and system are full of water and have been bled.
(The CTC EcoZenith i250 is bled through the bleed vent valve on the top cover of the product.)
2. Ensure that, where applicable, the brine system is filled with water and anti-freeze and that it is bled, or ensure that the compressor is blocked.
(This applies when docking with the CTC EcoPart 400.)
3. Check that all connections are tight.
4. Check that sensors and the radiator pump are connected to the power source.
5. The backup heating thermostat has OFF as its factory setting. The recommended position is ❄️ = Antifreeze setting, around +7°C. The backup heating thermostat is reset on the electrical switchboard behind the front panel. It is in the OFF position when it is turned anticlockwise as far as it will go (the screwdriver slot should be vertical).

NB: At the end of the installation, check the current transformers' connection. In this situation it is important that you have switched off any major consumers of electricity in the house. Also make sure that the backup thermostat is turned off.

Turn the boiler vent valve so that any air can be evacuated.

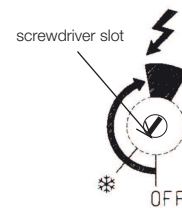

Symbol for backup heating thermostat:

First start

Switch on the power using the safety switch. The display comes on.
CTC EcoZenith i250 now asks the following:

1. Select language and press OK
2. Confirm that the system is filled with water and press OK. Press next.
3. Size of main fuse Choose between 10 and 35 A.
4. Enter the supply voltage 3x400 (1x230/3x230 apply only to export variants)
5. Specify the maximum electric heater power. Choose between 0.0 and 9.0 kW in different steps.
This applies to electric heaters in the upper tank.
6. Select the option permitting the compressor (if the collector system is ready or the air/water pump is already installed). When the compressor is started for the first time, it is automatically checked that it is running in the correct direction. An error message is displayed in the panel display if it is rotating in the wrong direction. Switch any two phases to change the direction of rotation.
7. Brine pump On, Auto (Auto/10d/On) (For CTC EcoHeat/EcoPart only)
Auto means that the brine pump is automatically operating at the same time as the heat pump (factory setting).
10d means that the brine pump is running continuously during the first 10 days in order to assist with bleeding.
"On" means that the brine pump is running constantly.
8. Specify max. primary flow 1 °C for radiator system 1.
9. Specify inclination 1 for radiator system 1.
10. Specify the adjustment for radiator system 2.
11. Current sensors identified. The CTC EcoZenith i250 then starts and the start menu appears.
12. Enter the set values in the parameter list so that the customer knows what has been set in addition to factory settings during installation.

■ Save these settings under:
Installer/Settings/
Save settings

