



Providing sustainable energy solutions worldwide

Installation- and maintenance instruction

CTC 380 S

Model 18 / 22 / 27 / 33 / 40 / 50 / 63

IMPORTANT

READ CAREFULLY BEFORE USE
KEEP FOR FUTURE REFERENCE



Enertech Group

Installation- and maintenance instruction

CTC 380 S

Model 18 / 22 / 27 / 33 / 40 / 63



For your own reference

Fill in the information below. It may be useful if anything should happen

Product	Manufacturing No.
---------	-------------------

Plumber	Name
Date	Telephone No.

Electrician	Name
Date	Telephone No.

Chimney sweep	Name
Date	Telephone No.

With reservation for typing errors. Subject to alterations in design.

Table of contents

GENERAL INFORMATION	4		
Welcome	5	3.1	General information. 18
Important to remember!	6	3.2	Power supply 18
Safety Instructions	6	3.3	Main switch 18
General installation conditions	6	3.4	Heating circuit pump 18
1. Technical information	7	3.5	Heating circuit mixing valve 18
1.1 Technical data	7	3.6	DHW charging pump 18
1.2 Measurements	8	3.7	Safety limit thermostat (STB) 18
1.3 Description	9	3.8	Electrical diagram 582451/1 19
2. Installation	10	4. First start - Commissioning	20
2.1 General information	10	4.1 Before first start	20
2.2 Boiler room	10	4.2 First start	20
2.3 Transport	10	4.3 After first start	20
2.4 Unpacking	11	5. Operation	21
2.5 Boiler stand	11	5.1 General information	21
2.6 Connection to chimney	12	5.2 Regular inspection	21
2.7 Flue gas temperatures	12	5.3 Standstill	21
2.8 Hydraulic connection boiler	13	5.4 Frost risk	21
2.9 Safety valve boiler	13	5.5 Boiler cleaning	22
2.10 Heating circuit pump	14	5.6 Spiro-Condens system cleaning	23
2.11 Heating circuit mixing valve	14	5.7 Drainage	25
2.12 Connection domestic hot water (DHW) and secondary heating circuit	14	5.8 Oil operation	25
2.13 DHW charging pump	14	5.9 Operations disturbance	26
2.14 System diagrams	15	6. Comfort control	27
2.15 Drainage/Drain valve	15		
2.16 Filling	15		
2.17 Siphon	15		
2.18 Neutralisation box	15		
2.19 Chimney solutions	16		
3. Electrical installation boiler	18		

Welcome



Congratulations! You have just bought a CTC 380 S a 3-stroke oil heating boiler for progressive heating, which really corresponds to the present market demands of low energy consumption, comfort and low environmental influence.

We hope you will be very pleased with your CTC 380 S and you can read about how to operate your boiler in the following pages.

The CTC 380 S is designed to last for many years, and it is here you will find the information you need to operate and maintain the boiler unit correctly and ensure its longevity.

- The CTC 380 S is designed for firing with a minimum of ecologically harmful emissions and energy losses.
- The CTC 380 S is available in seven sizes from 18-63 kW.
- The CTC 380 S supplies the total requirement of heating and DHW of the house.
- The CTC 380 S has in order to simplify the installation, water- and flue gas connections on the top as well as the rear side of the boiler.
- The CTC 380 S is equipped with an adapted, extensional weather-compensated Comfort-control which totally fulfils the requirements of a comfortable and energy-saving operation.
- The CTC 380 S is thanks to the space-generous burner door and easily accessible combustion surfaces very maintenance-friendly.
- The type indication of the boiler is found on the product label on top of the boiler.

Important to remember!

Especially check the following points at delivery and installation:

- The installation must be carried out by authorized personnel according to existing engineering standards and building regulations.
- A correct function of the CTC 380 S, as well as the manufacturer warranty to be valid is only guaranteed when the installation, handling and maintenance are made as by the recommendations in this technical manual.
- Operation disturbances and defects which are caused by a not workmanlike handling as well as direct violent handling of the product, liberates the manufacturer from its warranty commitments.
- Remove the packaging. Before installation, check that the product has not been damaged during transport. Notify the forwarding agent of any transport damage.
- Check that a safety valve drain pipe to the floor drain is being fitted at the installation.
- Check the condition of the chimney and secure its durability against condensate.
- Please read the chapter about cleaning and maintenance in the end of this manual.
- Check the pressure in the expansion vessel annually.
- Please, hand over this technical manual to the customer after the installation!

Safety Instructions

The following safety instructions should be followed when handling, installing and using the CTC 380 S:

- Ensure that the boiler is currentless before any interventions.
- Do not flush the boiler or any of its control equipment with water.
- The flue gas channel and the ventilation duct of the boiler room for air supply must not be blocked.
- Check that the burner and its oil tubes are tight.
- The operating switch of the boiler must be off if the oil burner is opened and in maintenance position, for example during cleaning or service.
- This appliance is not intended for use by persons (including children) with reduced physical, sensory or mental capabilities, or lack of experience and knowledge, unless they have been given supervision or instruction concerning use of the appliance by a person responsible for their safety.
- Children should be supervised to ensure that they do not play with the appliance.

General installation conditions

A correct function of the CTC 380 S, as well as the manufacturer warranty to be valid is only guaranteed when the installation, handling and maintenance are made as by the recommendations in this technical manual.

Operation disturbances and defects which are caused by a not workmanlike handling as well as direct violent handling of the product, liberates the manufacturer from its warranty commitments. Please, hand over this technical manual to the customer after the installation!

 Regulations: The installation of the boiler and the heating system must be carried out by authorized personnel according to existing engineering standards and building regulations.

1. Technical information

1.1 Technical data

3-stroke oil-heating boiler CTC 380 S					
Model		18	22	27	33
Rated output	kW	18,3	22	27,3	33,9
Rated input	kW	19,6	23,7	29,2	36,1
Oil supply	kg/h	1,65	2,0	2,46	3,05
Flue gas mass flow	g/s	8,2	9,9	12,2	14,7
Boiler resistance	mbar	0,07	0,10	0,14	0,21
Boiler water resistance (Δ 20K)	mbar	2,0	2,0	3,0	3,0
Flue gas losses *	%	5,49	5,19	5,61	5,7
Radiation losses *	% / W	1,11 / 216	1,11 / 216	0,79 / 215	0,6 / 215
Boiler efficiency	%	93,4	93,7	93,6	93,7
Flue gas temperature *	°C	138	136	146	160
Boiler efficiency at 70 °C	%	93,8	94	94	94,1
Flue gas temperature 70 °C	°C	130	128	138	152
Max. Operation pressure boiler (PS)	Bar	3	3	3	3
Max. Operation temperature boiler	°C	110	110	110	110
Water content	l	98,5	98,5	92	92
Weight	kg	197	197	200,5	210
Number of turbulators	Pcs.	6	6	9	9
Turbulator model		21/45	27/45	27/45	21/45
Electrical data		230V 1N~	230V 1N~	230V 1N~	230V 1N~

3-stroke oil-heating boiler CTC 380 S					
Model		40	50	63	
Rated output	kW	39,7	51,2	61,6	
Rated input	kW	42,7	55,1	66,9	
Oil supply	kg/h	3,6	4,65	5,65	
Flue gas mass flow	g/s	17,1	23,7	29,7	
Boiler resistance	mbar	0,4	0,29	0,5	
Boiler water resistance (Δ 20K)	mbar	5,0	8,0	9,0	
Flue gas losses	%	5,7	6,75	7,61	
Radiation losses	% / W	0,6 / 215	0,45 / 249		
Boiler efficiency	%	1,11 / 216			
Flue gas temperature *	°C				
Boiler efficiency at 70 °C	%				
Flue gas temperature 70 °C	°C				
Max. Operation pressure boiler (PS)	Bar				
Max. Operation temperature boiler	°C				
Water content	l				
Weight	kg				
Number of turbulators	Pcs.				
Turbulator model					
Electrical data				230V 1N~	

* According to
EN 303-3

1.2 Measurements

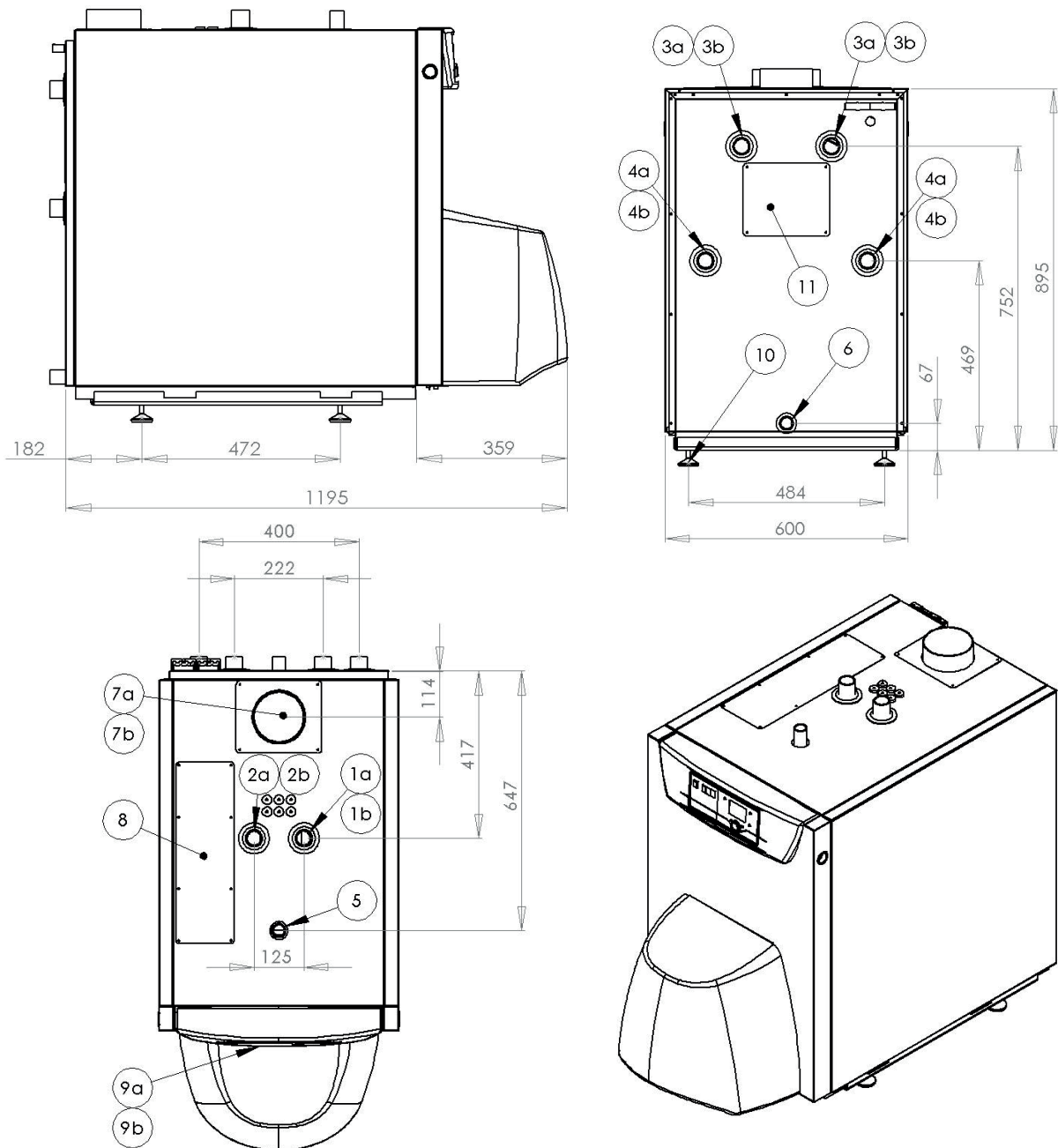

Legend

- 1a. Primary flow top R 1", (18-33)*
- 1b. Primary flow top R 1 ¼", (40-63)*
- 2a. Return flow top R 1", (18-33)*
- 2b. Return flow top R 1 ¼", (40-63)*
- 3a. Primary flow rear R 1", (18-33)*
- 3b. Primary flow rear R 1 ¼", (40-63)*
- 4a. Return flow rear R 1", (18-33)*
- 4b. Return flow rear R 1 ¼", (40-63)*
- 5. Expansion connection R 1"

- 6. Drainage R 1"
- 7a. Flue gas outlet top " 130 mm, (18-33)*
- 7b. Flue gas outlet top " 150 mm, (40-63)*
- 8. Basic unit Siemens RVS13.143
- 9a. Operator unit Siemens AVS37.294
- 9b. Power pack Siemens AVS16.290
- 10. Adjustable feet M10
- 11. Flue gas outlet rear

*) Output-sizes in kW

1.3 Description

The principle parts of the design consist of measure made steel/stainless steel plates. The boiler has been pressure- and tightness tested and is provided with skin-tight heat insulation as well as powder coated covers plates.

Basic unit

The basic unit of the Comfort-control – Siemens RVS43.143. For more information, see the part Electrical installation – Comfort-control.

Power pack

The power pack of the control panel – Siemens AVS16.290. For more information, see the part Electrical installation – Comfort-control.

Operator unit

The operator unit of the Comfort-control – Siemens AVS37.294. For more information, see the part Electrical installation – Comfort-control.

Hinged arm

The cleaning door is equipped with hinges which serves as a hinged arm. In that way is it easier to swing out the burner in connection to inspections and maintenance.

Burner hood

The burner hood is an integrated and sophisticated component part of the boiler.

Cleaning door

Thanks to the large cleaning door are the turbulators within easy reach as well as it facilitates the simultaneously cleaning and maintenance of the heating surfaces of the boiler.

Flue gas outlet

Connections on the top and rear side.

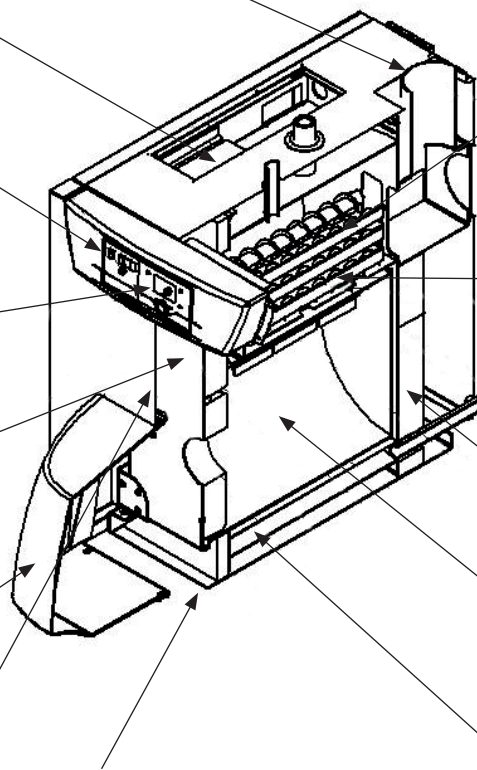

Turbulators

The function of the turbulators is to create turbulence of the flue gases, in order to improve the amount of thermal energy which is transmitted to the boiler water. All sizes are from factory, equipped with for each size adapted standard turbulators. The turbulators are reached behind the cleaning door in the front of the boiler.

Ripples

The boiler-sizes 33, 40 and 63 kW are equipped with ripples. The ripples enlarge the the surfaces in which the interchange of heat of the second flue gas stroke takes place. This results in an optimized heat transfer of the flue gases to the boiler water.

Heat insulation

In order to minimize the heat losses the boiler is provided with solid, skin-tight heat insulation.

Combustion chamber

The generous sized combustion chamber offers the adjusted Low NOx oil burner optimal performance.

DUO-Temperature System

The combustion chamber is surrounded by two mantles, which allows low-temperature operation protected from dew-point corrosion resulting in a long-life operation.

Adjustable feet

The boiler is equipped with four adjustable feet.

2. Installation

2.1 General information

The installation must be carried out by authorized personnel according to existing engineering standards and building regulations.

The boiler must be connected to an expansion vessel in an open (the expansion vessel of high placement together with safety- and return pipe) or a closed system. At an open system the distance between the expansion vessel and the highest placed radiator must not be less than 2,5 m to avoid oxygen-enrichment of the system.

! Check the pressure in the expansion vessel annually.

2.2 Boiler room

The boiler room must correspond to existing building regulations and particularly then the firing regulations of the present country.

The boiler room must be equipped with a venthole for air supply. The cross section area of the venthole must be at least $6,5 \text{ cm}^2$ pro 1 kW boiler output.

2.3 Transport

To avoid transport damage, do not unpack the boiler until it has been transported to its site in the boiler room. The boiler can be handled and lifted in the following way:

- Forklift
- Lift band round the pallet. Note! Only with the packing on.
- Sack barrow
- By putting carrier pipes in the water connections on the rear side, respectively the build-in 1" carrier sockets on the front side of the boiler

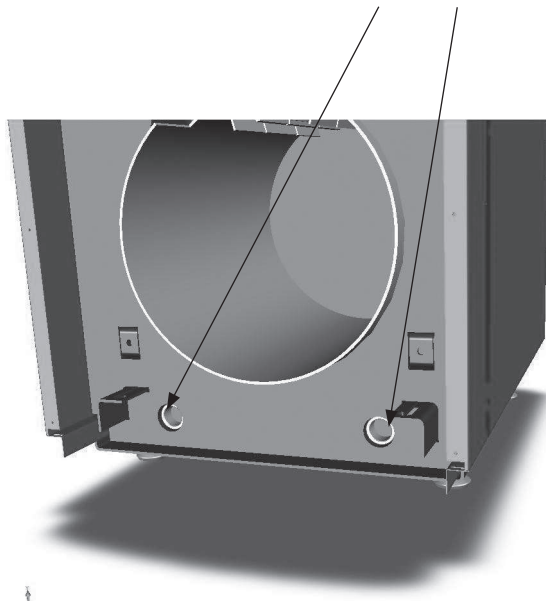

2.4 Unpacking

To avoid damage in the handling, do not unpack the boiler until it has reached its site in the boiler room. After the unpacking check, that the boiler has not been damaged during transport. Report eventual transport damages to the transporter.

Standard delivery:

- Oil-condensing boiler CTC 950 IC Condens
- Safety valve
- Siphon
- Primary flow sensor
- Outdoor sensor/DHW storage tank sensor

2.5 Boiler stand (Accessory kit)

The boiler stand is delivered as accessory kit. The boiler stand contain following parts:

1. Long sides (2x)
2. Short sides (2x)
3. Adjustable feet (4x) (Not in the accessory kit. Use the adjustable feet of the boiler!)
4. M6-Screws (12x) In order to decrease the lift weight of the boiler, remove the burner and cleaning door during the wall mounting.

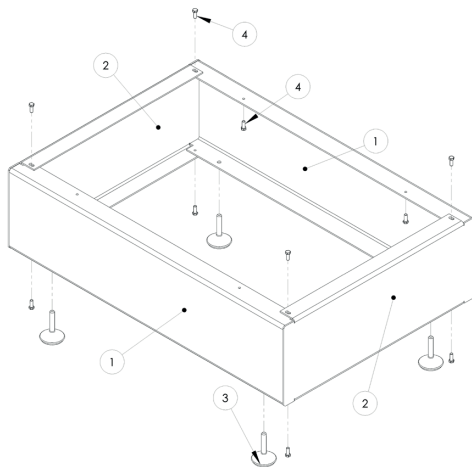

The boiler stand may be assembled according to following items:

1. Screw the long- and short sides together by using M6-Screws (8x).
2. Fasten the adjustable feet on the underside of the boiler stand.
3. Fasten M6-Screws (4x) from below on the upper side of the boiler stand.
4. Place the boiler on the boiler stand by using the M6-Screws in item 3. as guide pins. Do not fasten!



Continue the heating boiler installation with the hydraulic-, chimney- and electrical work.

2.6 Connection to chimney

Existing regulations for the design of the chimney must be taken into consideration. An optimal utilization of the flue gases and with that an energy-saving operation, requires hereby a mostly optimized adaption between boiler and burner.

The most important conditions are the following:

- Good thermal insulation in order to as much as possible avoid temperature losses from the connection between the boiler and chimney.
- Accurate sealing of the flue gas connections
- Smooth surfaces of the combustion chamber to avoid turbulence.
- Heat-shock resistance as well as water- and steamtight.

According to regulations:

- The boiler must be connected to the chimney with the shortest feasible flue duct at an angle of 30-45°.
- The flue duct must not be fully inserted through the chimney wall.
- If flue ducts with a cross-sectional dimension which deviate from the dimension of the flue gas outlet would be used, the connection must be cone-shaped. Cone angle of maximum 7,5°.
- By the construction of the flue duct between boiler and chimney must feasible actions be taken to secure that no condensate can flow back to the boiler (condensate trap).

2.7 Flue gas temperatures

When a new boiler is being connected to an old chimney, the chimney is often not dimensioned to the new high efficiency of the boiler, which may easily result in condensation in the chimney depending on lower flue gas temperatures. In order to ventilate the chimney with warmer boiler room air, a draught interrupter can be mounted.

All boiler-sizes of the CTC 380 Ecoswiss serie has for the current output-size design related operational flue gas temperatures. For flue gas temperature data, see Technical information.

2.8 Hydraulic connection boiler

The dimensioning and plumbing of the system shall be accomplished according to the measurements in the part Technical information.

2.9 Safety valve boiler

In a closed system, an approved safety valve according to existing regulations must be mounted.

The max. Operation pressure of the boiler is 3 bars. The connection pipebetween boiler and safety valve must be constructed in such way that no pressure increase is possible. The safety valve drain pipe must be uncovered and visible. Possible exhausting high-temperature hot water must without danger be removed (Caution! Risk of scalding)

2.10 Heating circuit pump

A heating circuit pump must be mounted on the primary flow of the boiler. The pump is being supplied with electric current from the boiler. For more information concerning system principles and connections, see Electrical Installation – Comfort-Control.

2.11 Heating circuit mixing valve

A heating circuit mixing valve must be mounted on the primary flow of the boiler. The heating circuit mixing valve is being supplied with electric current from the boiler. For more information concerning system principles and connections, see Electrical installation – Comfort-Control.

2.12 Connection domestic hot water (DHW) Secondary heating circuit

The connections located on the rear side of the boiler makes it possible to connect the boiler to a secondary heating circuit. These connections offer also the possibility to connect the boiler to a water heater system. The temperature of the return flow to the boiler must not be lower than 45°C.

2.13 Drainage/Drain valve

Shall be mounted on the drainage connection on the rear side of the boiler.

2.14 Connection water heater

If the CTC 380 S will be combined together with a water heater, is it of high importance that it's size and power capacity corresponds to the installed boiler output. The installation must correspond to existing building regulations. Recommended to connect on the rear primary- and return flow of the boiler.

For more information concerning system principles and connections, see Electrical installation – Comfort-Control.



If the size of the system exceeds the limits according to the diagram, the volume of the expansion vessel must increase.

3. Electrical installation boiler

3.1 General information.

The installation and wiring of the boiler must be carried out by an authorized electrician and in accordance with valid regulations. The internal boiler wiring is from factory prepared for the installation.

3.2 Power supply

The boiler should be connected to 230V 1N~ and protective earth.

3.3 Main switch

A main switch should be installed.

3.4 Heating circuit pump

The heating circuit pump for the heating system is being connected to the connection terminal on the basic unit. The switch for the pump is placed on the comfort-control of the boiler.

3.5 Heating circuit mixing valve

The heating circuit mixing valve for the heating system is being connected to the connection terminal on the basic unit.

3.6 Safety limit thermostat (STB)

If the boiler has been stored extremely cold the safety limit thermostat may have released.

Reset by pressing the button on the power section.

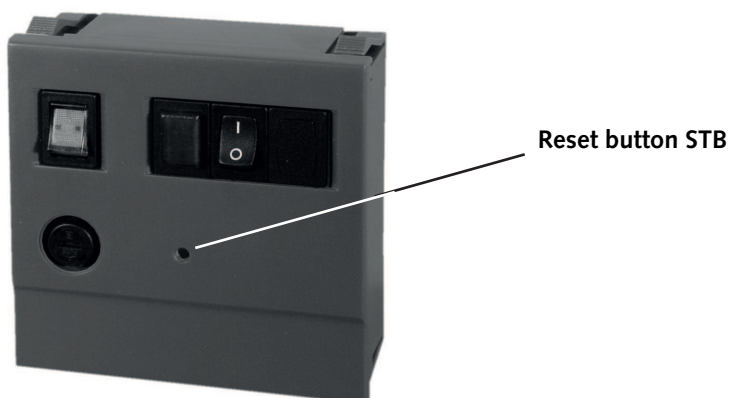

3.7 Electrical diagram E-582450

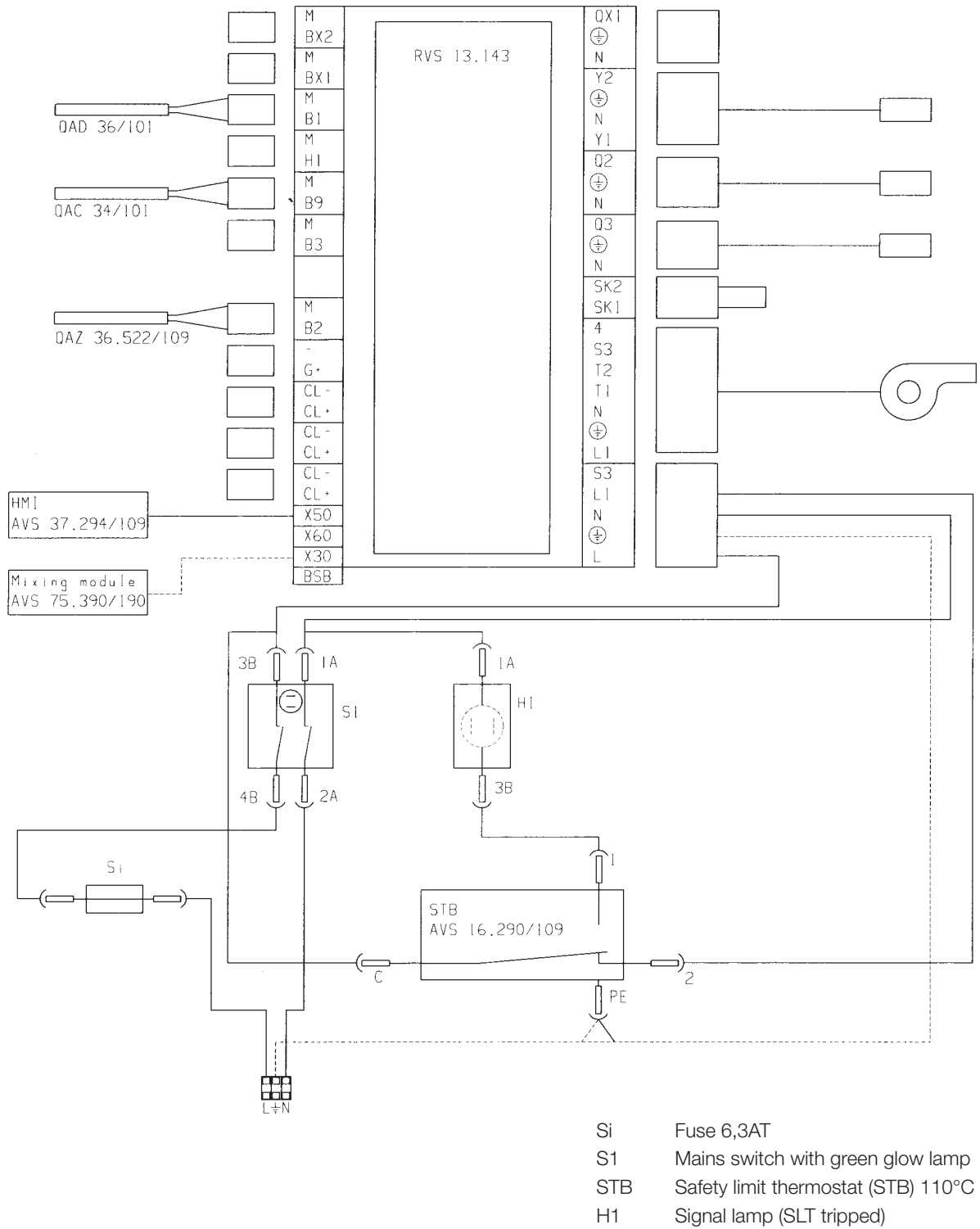

4. First start - Commissioning

4.1 Before first start

Check that:

- The boiler and heating system are filled with water.
- All connections are tight and that the chimney connection is made in an correct way.
- The oil tank is inspected according to existing regulations.
- An oil filter (type Tigerloop) is fitted to the burner.
- The electrical connections are made in an correct way.
- All sensors, burner, mixing valve and pumps are connected to the power supply.

4.2 First start

- Switch on the current with the mains switch.
- By commissioning applies the Comfort-control the factory pre-set standard values for set points, time program and operating modes. Though is it prerequisite to make settings of the time of the day and date. Further adjustments for personal requirements are performed according to the technical manual of the Comfort-control. (See also the part Electrical installation – Comfort-control.)
- Check that the oil burner starts.
- When the boiler has reached its operating temperature, check and adjust the oil burner in accordance with its technical manual. (See also the part Oil burner.)

4.3 After first start

Check that:

- All pipe connections are tight, tighten if necessary.
- The flue duct is tight and well insulated.
- The boiler temperature rises upon first start.
- Heat goes out to the heating system
- The heating circuit pump is running and can be controlled from the Comfort-control of the boiler.
- The tapping points of the house are provided with hot water as the boiler has turned warm.
- The function of the safety valve is faultless.
- The boiler and the heating system are well vented. Re-check after a few days.

5. Operation

5.1 General information

After the installation check together with the installer that the installation is fully ready for operation. Let the installer show you all important regulation devices, etc. so that you are well aware of how the boiler installation functions and should be maintained. Vent the radiators after app. 3 days of operation and fill up with more water if necessary.

5.2 Regular inspection

The regular inspection should include following items:

- Check control of the pressure gauge (manometer). By too low pressure, fill-up water in the heating system by means of charging- and drainage device.
- Check control of the heating oil level in the tank.
- Check control of the settings of the Comfort-control.
- Check control of the temperature of the heating boiler, primary flow and flue gas.
- Check control of the burner according to the instructions manual for the burner
- In a closed system, check control of the safety valve by means of turning the regulation device of the valve. Check if water run out from the safety valve drain pipe.
- Neutralisationbox: Check its function and pH-value according to its manual and existing regulations.

5.3 Standstill

If the installation should be put out of operation, use the mains switch.

(See the part Electrical installation – Comfort-control.)

5.4 Frost risk

Never put the boiler in operation if its pose a risk that the boiler or parts of the heating system is frozen. This leads to damages on the boiler and piping in the house. Consult your heating technician for advice.

Concerning protection mode.

(See the part Electrical installation – Comfort-control.)

6. Comfort-control

General information

The boiler is factory equipped with the Comfort-control Siemens Albatros2. The Comfort-control consists of a basic unit, power pack and operator unit. The power pack and operator unit creates together the control panel of the boiler. Part 6. describes the principal information concerning the Comfort-control. For more information concerning functions, programming, system principles etc., please see the Albatros2 Boiler Controller User Manual.

Basic unit RVS43.143

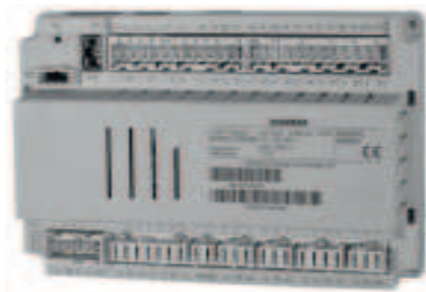

Terminal markings

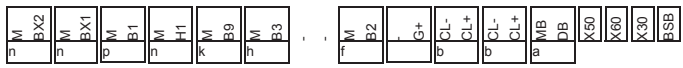
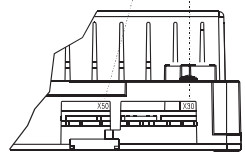
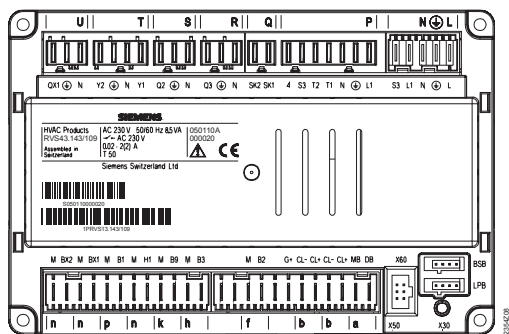
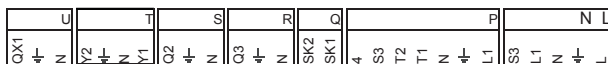

Mains voltage

	Use	Terminal	Type of connector
L ⏏ N L1 S3	Phase AC 230 V basic unit Protective earth Neutral conductor Phase AC 230 V burner Output burner fault	N ⏏ L	AGP4S.05A/109
L1 N T1 T2 S3 4	Phase burner Protective earth Neutral conductor Phase 1 st burner stage 1 st burner stage on Input burner fault Input burner stage 1 hours run	P	AGP8S.07A/109
SK1 SK2	Safety loop Safety loop	Q	AGP8S.02E/109
N ⏏ Q3	Neutral conductor Protective earth DHW charging pump / diverting valve	R	AGP8S.03A/109
N ⏏ Q2	Neutral conductor Protective earth 1st heating circuit pump	S	AGP8S.03B/109
Y1 N ⏏ Y2	1st heating circuit mixing valve opening Neutral conductor Protective earth 1st heating circuit mixing valve closing	T	AGP8S.04B/109
N ⏏ QX1	Neutral conductor Protective earth 1st multifunctional output	U	AGP8S.03C/109

Low voltage			
	Use	Steckplatz	Type of connector
BSB	Service tool OCI700	-	-
LPB	Local process bus	-	-
X60	Radio module AVS71.390	-	-
X50	Extension module AVS75.390	-	AVS82.490/109
X30	Operator unit / boiler control	-	AVS82.491/109
DB	LPB data	a	AGP4S.02H/109
MB	LPB ground		
CL+	Room unit 2 data	b	AGP4S.02A/109
CL-	Room unit 2 ground		
CL+	Room unit 1 data	b	AGP4S.02A/109
CL-	Room unit 1 ground		AGP4S.03D/109
G+	Room unit power supply 12V		
B2	Boiler sensor	f	AGP4S.02B/109
M	Ground		
B3	DHW sensor top	h	AGP4S.02C/109
M	Ground		
B9	Outdoor sensor	k	AGP4S.02D/109
M	Ground		
H1	Digital-/0..10V input	n	AGP4S.02F/109
M	Ground		
B1	Flow sensor	p	AGP4S.02G/109
M	Ground		
BX1	Multifunctional sensor input 1	n	AGP4S.02F/109
M	Ground		
BX2	Multifunctional sensor input 2	n	AGP4S.02F/109
M	Ground		

Checking the LED

LED off: No power supply

LED on: Ready to operate

LED flashes: Local faults

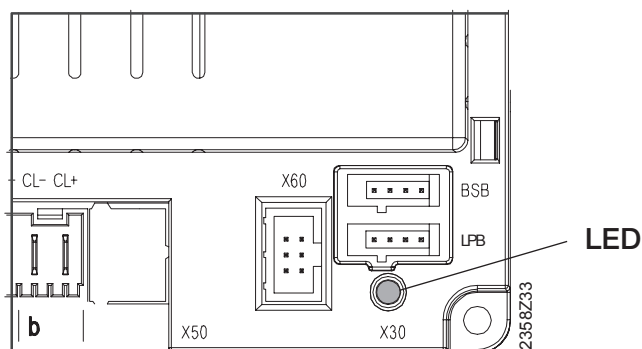

Power pack AVS16.290



Terminal	Name	
L	Phase AC 230 V	brown
⊕	Protective earth	green + yellow
N	Neutral conductor	blue

Connection to basic unit

Terminal	Name	
1	L	Phase AC 230 V basic unit
2	⊕	Protective earth
3	N	Neutral conductor
4	L1	Phase AC 230 V burner
5	S3	Input burner fault

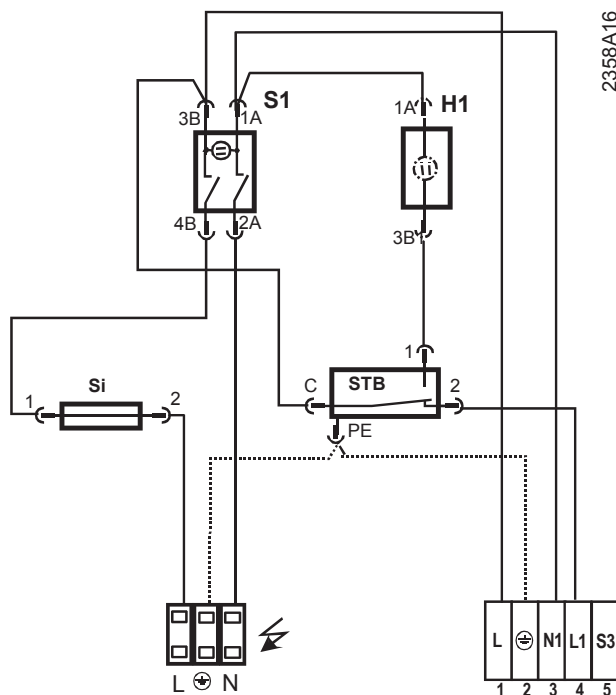





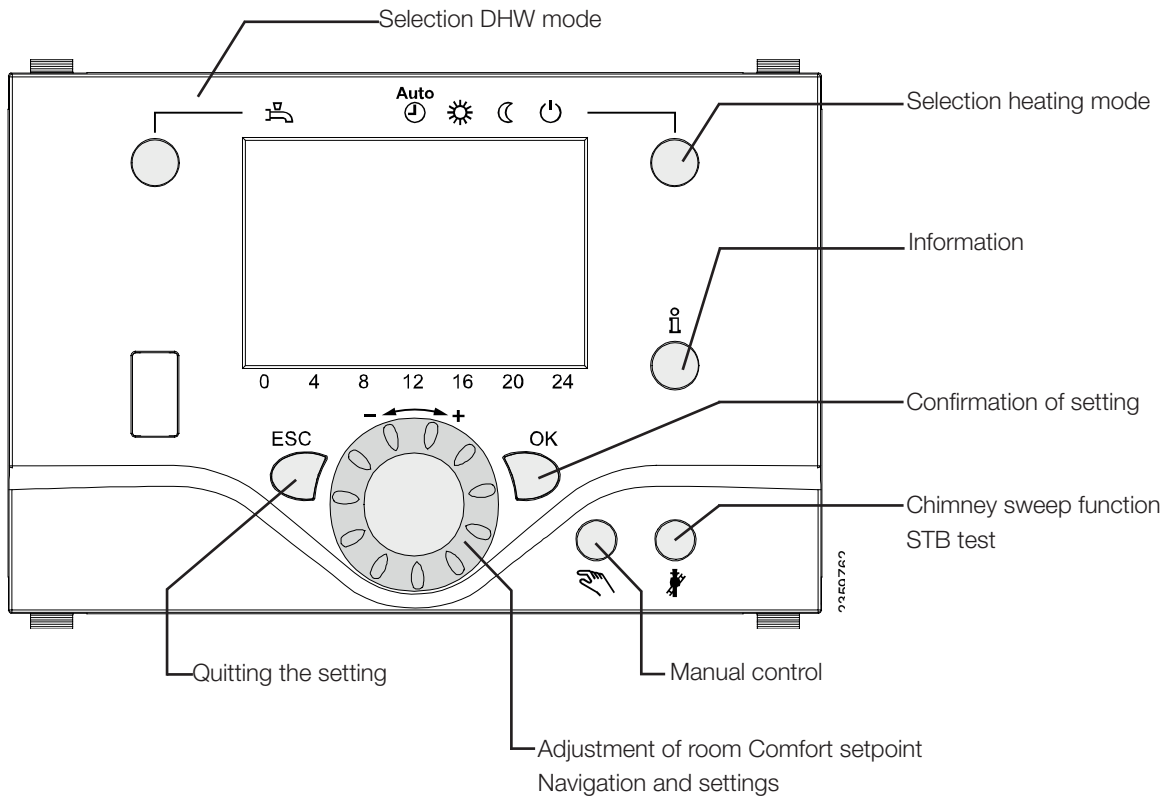





- Si Fuse 6,3AT
- S1 Mains switch with green glow lamp
- STB Safety limit thermostat (SLT) 110°C
- H1 Signal lamp (STB tripped)

6.4 Operator unit AVS37.294



Display choices

- | | |
|---|--|
|  Heating to the Comfort setpoint | INFO Info level activated |
|  Heating to the Reduced setpoint | PROG Programming activated |
|  Heating to the frost protection setpoint | ECO Heating function temporarily off ECO function activ |
|  Process running - please wait |  Holiday function active |
|  Change battery |  Reference to heating circuit |
|  Burner in operation (only oil/gas burner) |  Maintenance / special mode |
| |  Error messages |

Change Language

- Press the "OK-button"
- Press the "i-button" for 3 seconds, the text "Endbenutzer" shall be visible.
- Select "Endbenutzer" and press "OK".
- Select "Bedieneinheit" and press "OK". "Bedieneinheit sprache" shall be visible.
- Press OK and select language and press "OK".
- Press "ESC" and "ESC" again.

Indication

Display showing all available segments

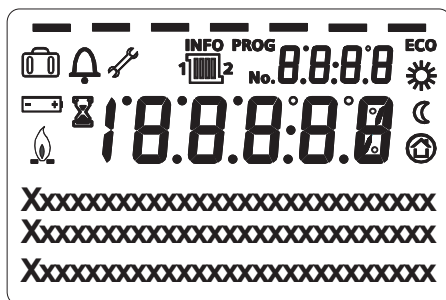

Selecting heating mode

Press the button to switch between the different operating modes. The choice made is indicated by a bar which appears below the symbols.

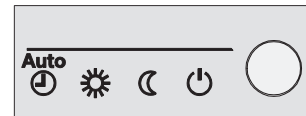

Automatic mode **AUTO**

Automatic mode controls the room temperature according to the time program.

Characteristics of automatic mode:

- Heating mode according to the time program
- Temperature setpoints according to heating program "Comfort setpoint" or "Reduced setpoint"
- Protective functions active
- Automatic summer / winter changeover (ECO functions)

Continous operation or

Continous operation maintains the room temperature at the selected operating level.

 Heating to the Comfort setpoint

 Heating to the Reduced setpoint

Characteristics of continous operation:

- Heating mode with no time program
- Protective functions active
- Automatic summer / winter changeover (ECO functions) and 24-hour heating limit inactive in the case of continuous operation with Comfort setpoint

Protection

When using Protection, the heating system is off. But it remains protected against frost (frost protection temperature), provided there is no power failure.

Eigenschaften des Schutzbetriebs:

- Heating off
- Temperature according to frost protection
- Protective functions active
- Automatic summer / winter changeover (ECO functions) and automatic 24-hour heating limit active

Selecting DHW heating mode

The button is used to switch DHW heating mode on and off. The choice is indicated by a bar which appears below the symbol..

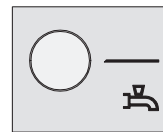

Trinkwasserbetrieb

- On

The DHW is heated according to the selected switching program.

- Off

No DHW heating, the protective function is active.

Trinkwasser-Push

To do this, keep the DHW operating mode button depressed for at least 3 seconds.

The DHW push can also be started when: 

- The operating mode is "Off"
- Operating mode changeover acts via H1 or centrally (LPB)
- All heating circuits have assumed the holiday mode

Adjusting the room temperature setpoint

Turn the setting knob to increase or decrease the Comfort setpoint.

For the Reduced setpoint

- Press the OK button
- Choose operating page "Heating circuit" and
- Adjust the "Reduced setpoint".

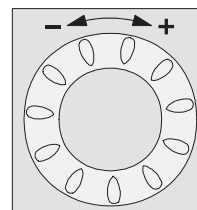

Each time you make a readjustment, wait at least 2 hours, allowing the room temperature to adapt.

Displaying information

The button is used to display information.

Possible displays

Depending on the type of unit, unit configuration and operating state, some of the info lines listed below may not appear.

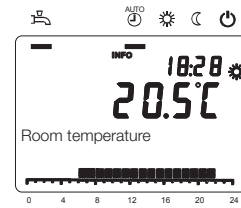

Displays

- Possible error messages from the error code list.
- Possible maintenance alarms from the maintenance code list.
- Possible special mode messages

Other displays:

- | | |
|----------------------------|------------------------------|
| - Room temperature | - Outside temperature min |
| - State DHW | - Date and time of day |
| - Room temperature minimum | - Outside temperature max |
| - State boiler | - Telephone customer service |
| - Room temperature maximum | - DHW temperature 1 |
| - Boiler temperature | - State heating circuit 1 |
| - Outside temperature | - State heating circuit 2 |

Exceptional cases

In exceptional cases, the display shows one of the following symbols:



Error messages

If this symbol appears, a plant fault has occurred. In this case, press the Info button to obtain more information.

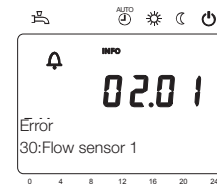

Maintenance or special mode

If this symbol appears, a maintenance alarm is delivered or the plant has changed to special mode. In this case, press the Info button to obtain more information.

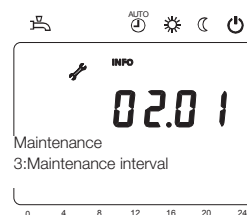

Reset function

The reset function for meters and the reset table parameters appears on the bottom line of the display, provided a reset is permitted on the current operating line (enduser / commissioning / heating engineer).

After activation with the OK button, the display shows a flashing "Yes".

After confirmation with the OK button, the relevant parameter or meters will be reset.

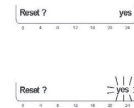

Manual control

When manual control is active, the relays are no longer energized and deenergized according to the control state, but are set to a predefined manual operating state depending on their function.

The burner relay energized in manual control can be deenergized by the electronic temperature controller (TR).

Setpoint adjustment with manual control

After manual control has been activated, a change to the basic display must be made. There, the maintenance / special mode symbol appears. Setpoint adjustment with manual control Press the Info button to switch to info display "Manual mode", where the setpoint can be adjusted.

Chimney sweep function

The chimney sweep function is activated by a short press (maximum 3 seconds) on the chimney sweep button. It produces the operating state required for making flue gas measurements.

STB test

The STB test (STB = safety limit thermostat) is activated by a long press (longer than 3 seconds) on the chimney sweep button. The button must be kept depressed during the entire test. If released, the test will be aborted.

The STB test is shown on the display.

The test must be made by qualified staff since the boiler temperature will be raised above the maximum limitations.



Programming

Setting principle

Settings that cannot be made directly with the help of operating elements are made through programming. For this purpose, the individual settings are structured in the form of operating pages and operating lines, thus forming practical groups of settings. The following example which shows the setting of the time of day and date shall explain this.

i Example “Setting the time of day“

- When pressing the ESC button, you go back one step; adjusted values will not be adopted
- If no setting is made for 8 minutes, the unit will automatically return to the basic display
- Operating lines may be hidden, depending on the type of unit, their configuration and user level

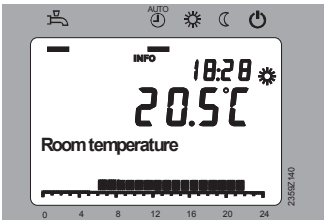
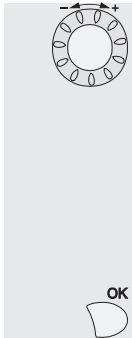
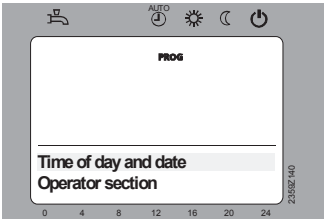
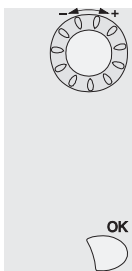
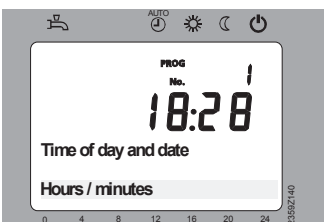
Operation	Display example	Description
<p>1</p> 		<p>You see the basic display. If the basic display is not shown, press the ESC button to return to it.</p> <p>Press the OK button.</p>
<p>2</p> 		<p>The bottom section of the display shows a number of operating pages.</p> <p>Turn the setting knob until operating page “Time of day and date“ appears.</p> <p>To confirm, press the OK button.</p>
<p>3</p> 		<p>In the bottom section of the display, the first operating line of operating page “Time of day and date“ appears.</p> <p>To confirm, press the OK button.</p>

Operation

Display example

Description

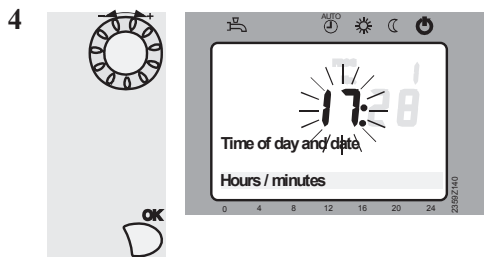

Turn the setting knob until the hours of the time of day are correct.

To confirm, press the OK button.

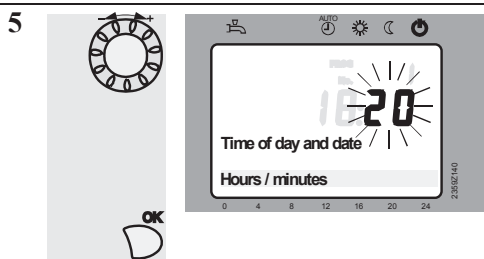

The display shows the minutes flashing.

Turn the setting knob until the minutes of the time of day are correct.

To confirm, press the OK button.

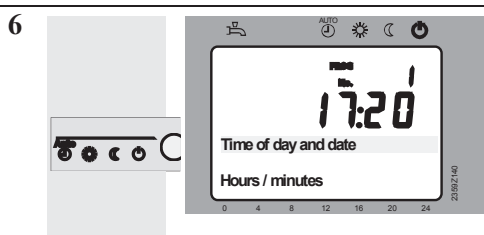

The settings are saved, the display stops flashing.

You can continue to make other settings, or you press the operating mode button to return to the basic display.



Now, you have returned to the basic display.

Example of menu structure

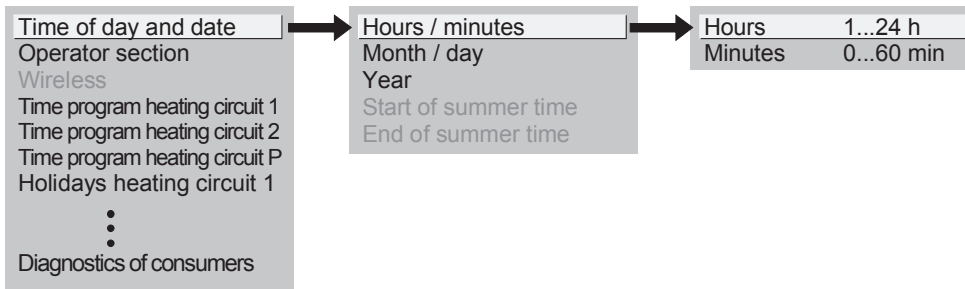

2359Z139

User levels

Certain user levels only allow certain user groups to make settings. To reach the required user level, proceed as follows:

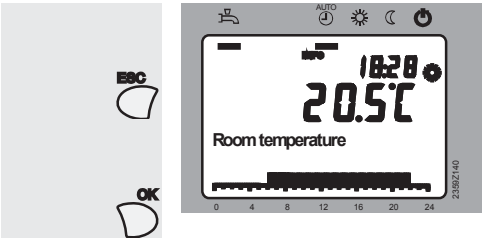
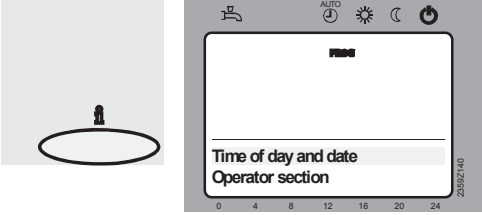
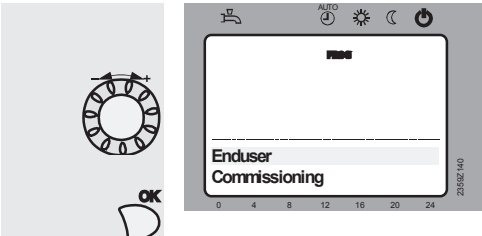
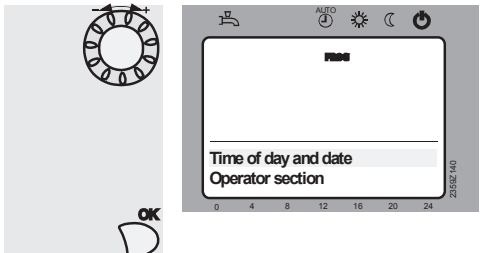
Operation	Display example	Description
1		<p>You see the basic display. If the basic display is not shown, press the ESC button to return to it.</p> <p>Press the OK button.</p>
2		<p>You are on user level "Enduser".</p> <p>Press the Info button for 3 seconds</p>
3		<p>You are given a choice of user levels.</p> <p>Turn the setting knob until the required user level is reached.</p> <p>Press the OK button</p>
		<p>You are now on the required user level.</p>

To reach the OEM level, enter the relevant code.

Setting structure for "Enduser"

The example given here shows that certain user levels do not allow certain settings to be made. The example shows them highlighted. On the unit, they are hidden.

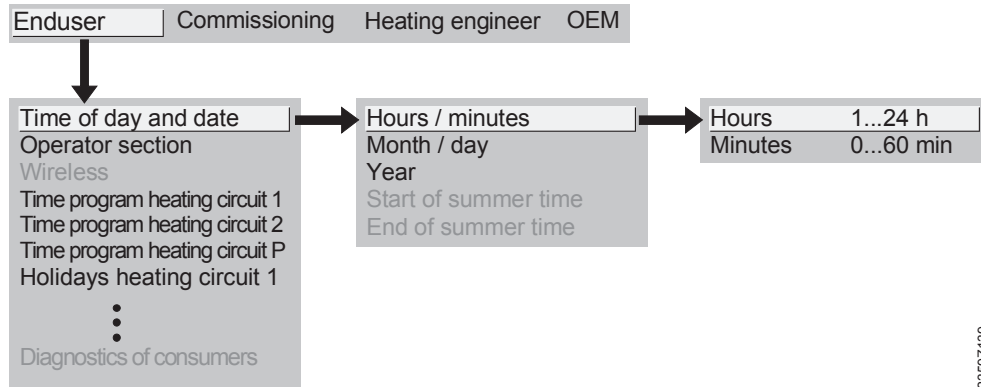

2359Z139

Setting structure for "Heating engineer"

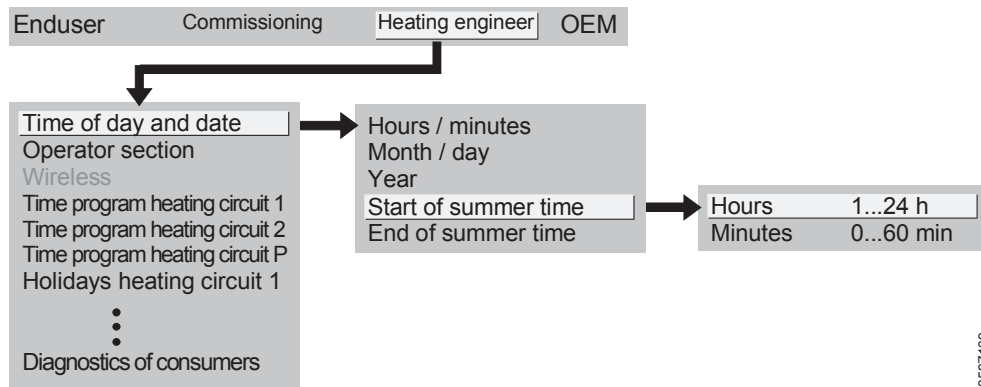

2359Z139

Commissioning

Prerequisites

To commission the units, the following steps must be carried out:

- Prerequisite is correct mounting and correct electrical installation and, in the case of wireless systems, correctly working radio links to all the auxiliary units
- Make all plant-specific settings. Special attention must be paid to operating page "Configuration".
For that purpose, the relevant operating level is to be selected as follows: Press the OK button on the operator unit to switch to programming. Press the Info button for at least 3 seconds and select operating level "Commissioning" with the setting knob. Then, press the OK button.
- Make the functional check as described below
- Reset the attenuated outside temperature (operating page "Diagnostics of consumers", operating line "Outside temp attenuated" (line 8703)))

Functional check

To facilitate commissioning and fault tracing, the controller allows output and input tests to be made. This allows to test the outputs and inputs. To make the tests, select operating page "Input/output test" and go through all available operating lines..

Operating state

The current operating state can be checked on operating page "State".

Diagnostics

For detailed diagnostics of the plant, check operating pages "Diagnostics heat source" and "Diagnostics consumer".

Time programs

For the heating circuits and DHW heating, a number of switching programs are available. They are activated in "Automatic" operation and control the change of the temperature levels via the selected switching times.

The switching times can be set in a combined way, that is, either commonly for several days or separate times for individual days. When preselecting groups of days like for instances Mo...Fr and Sa...Su that use the same switching times, setting of the switching programs is simplified.

- Press the "OK-button"
- Select "Time prog heating circuit 1" and press "OK".
- The text "Preselection" is shown.
- Press "OK" and the selection start flashing.
- You can select between program for Mo-Su, Mo-Fr, Sa-Su, or each day separately
- Select "1 st phase on" and press "OK".
- The time start flashing and you can select the start time for heating "comfort setpoint" Press "OK"
- Select "1 st phase off" and press "OK".
- The time start flashing and you can select the stop time for heating "comfort setpoint" Press "OK"
- Phase off means that "Reduced setpoint" is active.
- It is possible to select 3 phase for each day.
- Press "ESC" and "ESC" again.

All time programs can be reset to the default settings. Each time program has its own operating line to make this reset.

In that case, individual settings will be lost!

Heating curve

The heating curve is used to generate the flow temperature setpoint, which is used to maintain a certain flow temperature depending on the prevailing weather conditions.

The heating curve can be adjusted with a number of settings, thus matching heat output and room temperature to individual needs.

As the heating curve slope is raised, the flow temperature increases the quicker the lower the outside temperature or, in other words, if the room temperature is not correct at low outside temperatures but correct at higher outside temperatures, the heating curve slope requires readjustment.

Increase adjustment: Raises the flow temperature, especially when outside temperatures are low. Decrease adjustment: Lowers the flow temperature, especially when outside temperatures are low. Default setting 1,5

Parallel displacement of the heating curve is used to change the flow temperature evenly across the entire outside temperature range or, in other words, if the room temperature is always too high or too low, a readjustment must be made with the help of the parallel displacement.

- Press the “OK-button”
- Select “Heating circuit 1” and press “OK”
- Select Menu 720 “Heating curve slope” and press “OK”
- Select setpoint and press “OK” for confirm
- Select Menu 721 “Heating curve displacement” and press “OK”
- Select setpoint and press “OK” for confirm
- Press “ESC” and “ESC” again

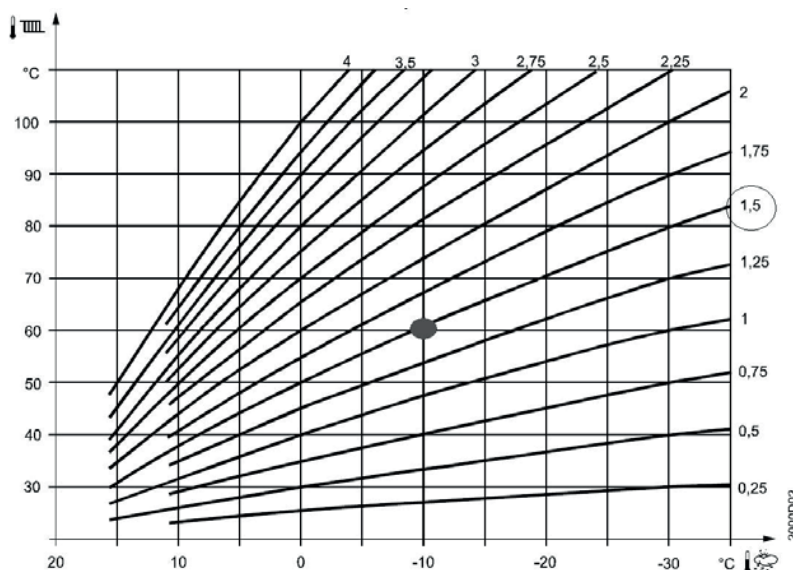

Flow temperature limitation

Using this limitation, a temperature range for the flow temperature setpoint can be defined. If the flow temperature setpoint demanded by the heating circuit reaches the relevant limit and the heat request increases or decreases, the flow temperature setpoint will be maintained at the maximum or minimum limit.

If you want to have floor heating in the summer for example in a basement or a bathroom you set the "Flow temp min" to a higher temperature.

Notice that the value for "Summer/winter setpoint stops the heating circuit at chosen temperature, in "Automatic mode". So you maybe have to select a higher temperature on this as well.

To select a value for the set points do as follow:

- Press the "OK-button"
- Press the "i-button" for 3 seconds.
- Select "Commissioning" and press "OK".
- Select "Heating circuit 1" and press "OK".
- Select "Flow temp setpoint min" (Menu 740) and press "OK"
- The temperature starts flashing.
- Select a temperature for min flow temp, and press "OK" to confirm.
- Select "Flow temp setpoint max" (Menu 741) and press "OK"
- Select a temperature for max flow temp, and press "OK" to confirm.
- Press "ESC" and "ESC" again.

List of displays

Priorities are assigned to pending errors. From priority 6, alarm messages are delivered, which are used by remote supervision (OCI). In addition, the alarm relay will be set.

Error code	Description of error	Priority
0	No error	
10	Outside temperature sensor error	6
20	Boiler temperature 1 sensor error	9
25	Solid fuel boiler temperature (wood) sensor error	9
26	Common flow temperature sensor error	6
28	Flue gas temperature sensor error	6
30	Flow temperature 1 sensor error	6
32	Flow temperature 2 sensor error	6
38	Flow temperature primary controller sensor error	6
40	Return temperature 1 sensor error	6
46	Return temperature cascade sensor error	6
47	Common return temperature sensor error	6
50	DHW temperature 1 sensor error	9
52	DHW temperature 2 sensor error	9
54	DHW primary controller sensor error	6
57	DHW circulation temperature sensor error	6
60	Room temperature 1 sensor error	6
65	Room temperature 2 sensor error	6
68	Room temperature 3 sensor error	6
70	Buffer storage tank temperature 1 sensor error	6
71	Buffer storage tank temperature 2 sensor error	6
72	Buffer storage tank temperature 3 sensor error	6
73	Collector temperature 1 sensor error	6
74	Collector temperature 2 sensor error	6
81	Short-circuit LPB	6
82	LPB address collision	3
83	BSB wire short-circuit	6
84	BSB address collision	3
85	BSB radio communication fault	6
98	Extension module 1 fault (common fault status message)	6
99	Extension module 2 fault (common fault status message)	6
100	2 clock time masters (LPB)	3
102	Clock time master without backup (LPB)	3
105	Maintenance message	5
109	Boiler temperature supervision	9
110	Lockout by SLT	9

Error code	Description of error	Priority
117	Upper pressure limit (crossed)	6
118	Critical lower pressure limit (crossed)	6
121	Flow temperature 1 (HC1) supervision	6
122	Flow temperature 2 (HC2) supervision	6
126	DHW charging supervision	6
127	Legionella temperature not reached	6
131	Burner fault	9
146	Configuration error common message	3
171	Alarm contact 1 (H1) active	6
172	Alarm contact 2 (H2) active	6
173	Alarm contact 3 (EX2/230VAC) active	6
174	Alarm contact 4 (H3) active	6
176	Upper pressure limit 2 (crossed)	6
177	Critical lower pressure limit 2 (crossed)	6
178	Temperature limiter heating circuit 1	3
179	Temperature limiter heating circuit 2	3
217	Sensor error common message	6
218	Pressure supervision common message	6
243	Swimming pool temperature sensor error	6
320	DHW charging temperature sensor error	6
321	Instantaneous DHW heater outlet temperature sensor error	6
322	Upper pressure limit 3 (crossed)	6
323	Critical lower pressure limit 3 (crossed)	6
324	BX same sensors 3	3
325	BX/extension module same sensors	3
326	BX/mixing valve group same sensors	3
327	Extension module same function	3

Error code	Description of error	Priority
328	Mixing valve group same function	3
329	Extension module / mixing valve group same function	3
330	Sensor BX1 no function	3
331	Sensor BX2 no function	3
332	Sensor BX3 no function	3
333	Sensor BX4 no function	3
334	Sensor BX5 no function	3
335	Sensor BX21 no function	3
336	Sensor BX22 no function	3
337	Sensor BX1 no function	3
338	Sensor BX12 no function	3
339	Collector pump Q5 missing	3
340	Collector pump Q16 missing	3
341	Collector sensor B6 missing	3
342	Solar DHW sensor B31 missing	3
343	Solar integration missing	3
344	Solar controlling element buffer K8 missing	3
345	Solar controlling element swimming pool K18 missing	3
346	Solid fuel boiler pump Q10 missing	3
347	Solid fuel boiler comparison sensor missing	3
348	Solid fuel boiler address error 3	3
349	Buffer return valve Y15 missing	3
350	Buffer storage tank address error	3
351	Primary controller / system pump address error	3
352	Pressureless header address error	3
353	Cascade sensor B10 missing	3

7. Oil burner

7.1 General information

The CTC 380 S provides optimum combustion conditions for the oil burners available on the market. The commissioning, adjustments and maintenance of the burner must be performed by an authorized heating technician according to the technical manual of the burner. See also the part Commissioning.

8. Commissioning

8.1 Before commissioning

Check that:

1. The boiler and heating system are filled with water.
2. All connections are tight and that the chimney connection is made in an correct way.
3. The oil tank is inspected according to existing regulations.
4. The electrical connections are made in an correct way.

8.2 Commissioning

1. Switch on the current with the mains switch.
2. By commissioning applies the Comfort-control the factory pre-set standard values for set points, time program and operating modes. Though is it prerequisites to make settings of the time of the day and date. Further adjustments for personal requirements are performed according to the technical manual of the Comfort-control.
3. See also the part Electrical installation - Comfort-control.
4. Check that the oil burner starts.
5. When the boiler has reached its operating temperature (70-80°C), check and adjust the oil burner in accordance with its technical manual. See also the part Oil burner.

8.3 After commissioning

1. All pipe connections are tight, tighten if necessary.
2. The flue duct is tight and well insulated.
3. The boiler temperature rises upon commissioning.
4. Heat goes out to the heating system
5. The heating circuit pump is running and can be controlled from the Comfort-control of the boiler.
6. The tapping points of the house are provided with hot water as the boiler has turned warm.
7. The function of the safety valve is faultless.
8. The boiler and the heating system are well vented. Re-check after a few days.

9. Operation

9.1 General information

After the installation check together with the installer that the installation is fully ready for operation. Let the installer show you all important regulation devices, etc. so that you are well aware of how the boiler installation functions and should be maintained. Vent the radiators after appr. 3 days of operation and fill up with more water if necessary.

9.2 Regular inspection

The regular inspection should include following items:

- Check control of the pressure gauge (manometer). By too low pressure, fill-up water in the heating system by means of charging- and drainage device.
- Check control of the heating oil level in the tank.
- Check control of the settings of the Comfort-control.
- Check control of the temperature of the heating boiler, primary flow and flue gas.
- Check control of the burner according to the instructions in the technical manual from the manufacturer.
- In a closed system, check control of the safety valve by means of either turning or lifting the regulation device of the valve. Check if water run out from the safety valve drain pipe.

9.3 Standstill

If the installation should be put out of operation, use the mains switch. See the part Electrical installation – Comfort-Control.

9.4 Frost risk

Never put the boiler in operation if its pose a risk that the boiler or parts of the heating system is frozen. This leads to damages on the boiler and piping in the house. Consult your heating technician for advice. Concerning protection mode, see the part Electrical installation – Comfort-Control.

9.5 Boiler Cleaning

The boiler must be currentless by the boiler cleaning!

- The combustion chamber is from the front easily cleaned:
- Remove the burner hood.
- Switch off the burner.
- Pull out the burner Eurostecker.
- Undo and remove the burner door screws. The door may now be swung out without dismantling of the burner.
- Remove the turbulators.
- Clean the combustion chamber and heating surfaces by using the supplied tube brushes.
- Reassemble the turbulators, close the burner door and put back the screws and tighten after finishing the cleaning.
- Connect the burner Eurostecker and switch on the burner.
- Attach the burner hood.

The boiler installation must be regularly cleaned according to existing regulations.

9.6 Drainage

The boiler must be currentless upon drainage. The drainage connection/ drain valve is low located on the rear side of the boiler. By drainage of the whole system must the heating circuit mixing valve be fully open. In a closed system air must be supplied.

9.7 Oil operation

General information: Adjustments and maintenance of the oil burner must always be performed according to the technical manual of the burner.

In order to secure that the installation operates correctly, has low energy consumption and minimizes the harmful emissions, is it of great importance that maintenance with a check control in consideration of the setting values is performed on a regularly basis (recommended annual).



If you have questions concerning maintenance or any product defaults, please adress to your installer.

9.8 Operations disturbance

Burner disturbance:

- Check if there is oil in the tank.

Burner disturbance signal lamp lights:

- Check if the oil filter is dirty. Take necessary actions according to instructions in the technical manual of the burner.

Boiler disturbance:

- The safety limit thermostat has released. Reset by pressing the button on the power pack. See also Electrical installation.

Power supply to boiler disconnected:

- Check the fuse on the power pack. Check if the mains switch on the power pack is switched on. See also Electrical installation.

Uninsufficient room heating:

- Check the settings of the Comfort-control.
See also Electrical installation – Comfort-Contro.

Uninsufficient DHW:

- Check the settings of the Comfort-control.
See also Electrical installation – Comfort-Contro.



If none of the above mentioned actions correct the fault, we request you to contact your authorized installer or CTC directly.



Enertech Group

Försäkran om överensstämmelse
Déclaration de conformité
Declaration of conformity
Konformitätserklärung

Enertech AB
Box 313
S-341 26 LJUNGBY

försäkrar under eget ansvar att produkten
confirme sous sa responsabilité exclusive que le produit,
declare under our sole responsibility that the product,
erklären in alleiniger Verantwortung, dass das Produkt,

CTC 380 EcoSwiss, CTC 380 S

som omfattas av denna försäkran är i överensstämmelse med följande direktiv,
auquel cette déclaration se rapporte est en conformité avec les exigences des normes suivantes,
to which this declaration relates is in conformity with requirements of the following directiv,
auf das sich diese Erklärung bezieht, konform ist mit den Anforderungen der Richtlinie,

EC directive on:

Pressure Equipment Directive 97/23/EC, § 3.3
(AFS 1999:4, § 8)

Electromagnetic Compatibility (EMC) 89/336/EEC

Low Voltage Directive (LVD) 73/23 EEC, 93/68/EEC

Efficiency Directive 92/42/EWG

Överensstämmelsen är kontrollerad i enlighet med följande EN-standarder,
La conformité a été contrôlée conformément aux normes EN,
The conformity was checked in accordance with the following EN-standards,
Die Konformität wurde überprüft nach den EN-normen,

EN 719	EN 55014-1 /-2
EN 729-2	EN 55104
EN 288-3	EN 61 000-3-2
EN 1418	EN 60335-1
EN 287-1	EN 50165
EN 10 204, 3.1B	EN 303-1 /-2 /-3 /-4
EN 10 025, S 235 Jr-G2	EN 304

Ljungby 2005-11-18

Kent Karlsson

Technical Manager

